

Mounting Option

02-.128 (3.25) Dia. Mounting Holes

Contact Detail

542-Wire Wrap .025 Sq.(0.64 Sq.) - Tail LG=.645(16.38)

.156 [3.96] Contact Spacing x .200 [5.08] Row Spacing

THIS IS A C.A.D. GENERATED DRAWING
DO NOT MAKE MANUAL REVISIONS TO MASTER.



ISSUE NUMBER	
ORIGINAL	①

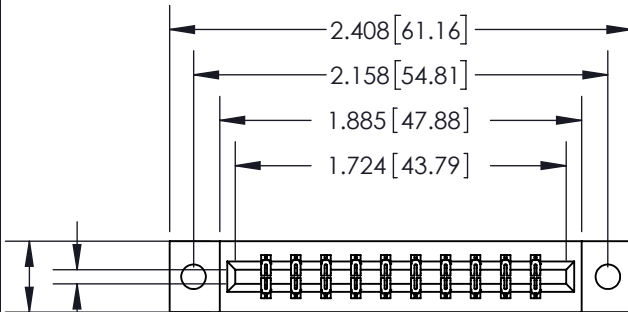

Card Slot Accepts .054 [1.37]
to .070 (1.78) Thick P.C. Board

0.370 [9.40]

0.350 [8.89]

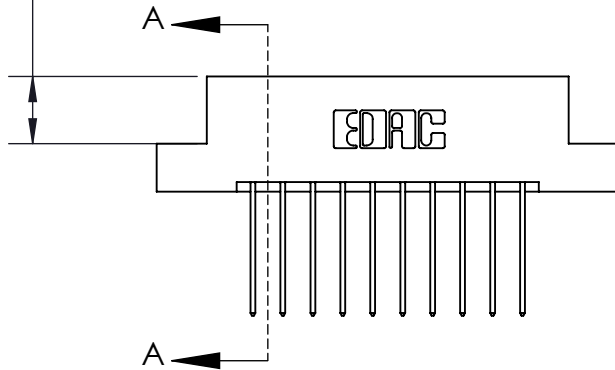

See Accompanying Page for:

- Bend Detail
- Mounting Options

833 Series High Temp Card Edge Connector

Part Number: 833-020-542-202



YOUR CONNECTION TO QUALITY & SERVICE

EDAC INC
TORONTO, ONTARIO
CANADA

THESE DRAWINGS AND SPECIFICATIONS
ARE THE PROPERTY OF EDAC INC. AND
SHALL NOT BE REPRODUCED, OR COPIED
OR USED AS THE BASIS FOR THE
MANUFACTURE OR SALE OF APPARATUS
WITHOUT WRITTEN PERMISSION.

ACAD REFERENCE NO.	833 ENG MASTER	
DRAWN:	J.LEE	DATE: OCT. 14/09
CHECKED:	DATE:	
SCALE:	NTS	SHEET 1 OF 3
DRAWING NUMBER	833 Assembly	ISSUE 1



555 Contact Code



556 Contact Code



558 Contact Code



559 Contact Code



560 Contact Code

833 Series High Temp Card Edge Connector Contact Bend Detail



EDAC INC
TORONTO, ONTARIO
CANADA

YOUR CONNECTION TO QUALITY & SERVICE

THESE DRAWINGS AND SPECIFICATIONS
ARE THE PROPERTY OF EDAC INC. AND
SHALL NOT BE REPRODUCED, OR COPIED
OR USED AS THE BASIS FOR THE
MANUFACTURE OR SALE OF APPARATUS
WITHOUT WRITTEN PERMISSION.

ACAD REFERENCE NO. 833 ENG MASTER

DRAWN: J.LEE DATE: OCT. 14/09

CHECKED: DATE:

SCALE: NTS SHEET 2 OF 3

DRAWING NUMBER 833 Assembly ISSUE 1

THIS IS A C.A.D. GENERATED DRAWING
DO NOT MAKE MANUAL REVISIONS TO MASTER.



ISSUE NUMBER	
ORIGINAL	①



833 Series High Temp Card Edge Connector Mounting Options



EDAC INC
TORONTO, ONTARIO
CANADA

YOUR CONNECTION TO QUALITY & SERVICE

THESE DRAWINGS AND SPECIFICATIONS ARE THE PROPERTY OF EDAC INC. AND SHALL NOT BE REPRODUCED, OR COPIED OR USED AS THE BASIS FOR THE MANUFACTURE OR SALE OF APPARATUS WITHOUT WRITTEN PERMISSION.

ACAD REFERENCE NO.	833 ENG MASTER	
DRAWN:	J.LEE	DATE: OCT. 14/09
CHECKED:		DATE:
SCALE:	NTS	SHEET 3 OF 3
DRAWING NUMBER	833 Assembly	ISSUE
		1