

P	LTR	DESCRIPTION	DATE	DWN	APVD
	4	REVISED DRAWING	15SEP2020	FD	PO
	A	ECR-21-001958	02MAR2021	SR	FD
	B	REVISED PER ECR-21-108141	20JUL2021	SM	FD
	BI	ECR-21-115785	29SEP2021	RK	FD

NOTES:

DIMENSIONS BEFORE APPLICATION

1 MATERIALS:
 CONTACT : COPPER ALLOY, TIN PLATED
 HOUSING: PPE+PS; COLOR: DARK GREY
 BUTTON: PPE+PS; COLOR: DARK GREY

2. APPLICABLE CABLES:

A) APPROVED ACCORDING UL FILE E13288 FOR SOLAR CABLES FROM 5.5 mm TO 7.2 mm

B) UNDER APPROVAL BY IEC62852 FOR FOLLOWING CABLE TYPES FROM DEFINED MANUFACTURERS:

- TE CABLE PN 2328394, 2.5 mm² (14 AWG)
- TE CABLE PN 2270245, 4 mm² (12 AWG)
- TE CABLE PN 2270260, 4 mm² (12 AWG)
- TE CABLE PN 2328400, 6 mm² (10 AWG)
- TE CABLE PN 2270215, 4 mm² (12 AWG)
- TE CABLE PN 2270259, 4 mm² (12 AWG)

BYSON 6351D 2.5mm²/14AWG

BYSON 6352D 4mm²/12AWG

BYSON 6353D 6mm²/10AWG

HONGLIN DPN4012A20 4mm²/12AWG

3 MOULDING PRODUCTION DATE MARKING

4 AREA FOR LASER PRINT DATA MATRIX AND PARTNUMBER

PPPPPPPPVYYWDFL#####

- P P P P P P P P = PART NUMBER
- V = VERSION CUSTOMER DRAWING
- Y Y = LAST TWO DIGITS OF YEAR 19
- W W = WEEK NUMBER
- D = WEEKDAY (1 MONDAY)
- F = FACTORY CODE (S = SZCZECIN, T = TRUTNOV)
- L = MANUFACTURING LINE (M=MANUAL, A=AUTOMATIC)
- ##### = SERIAL NUMBER (PRODUCTION PER DAY)

5 CABLE FOR REFERENCE ONLY

6 NOTE REMOVED

7 WHEN BUTTON AND HOUSING RIBS ARE ALIGNED, THE CONNECTOR IS CORRECTLY TERMINATED

8 MINIMUM CABLE INSERTION LENGTH 53.8 mm ± 2 mm

9. CHECK APPLICATION SPEC 114-133104 FOR PROPER CABLE CONNECTION

10. FOR PACKAGING FORMAT AND QUANTITY SEE 107-133104.

SCALE 1:2

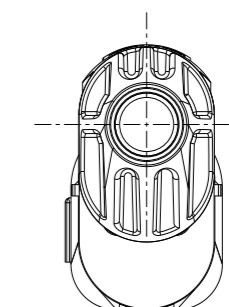
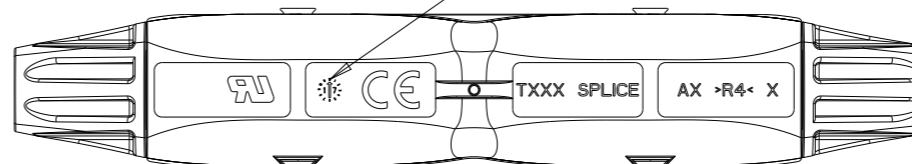
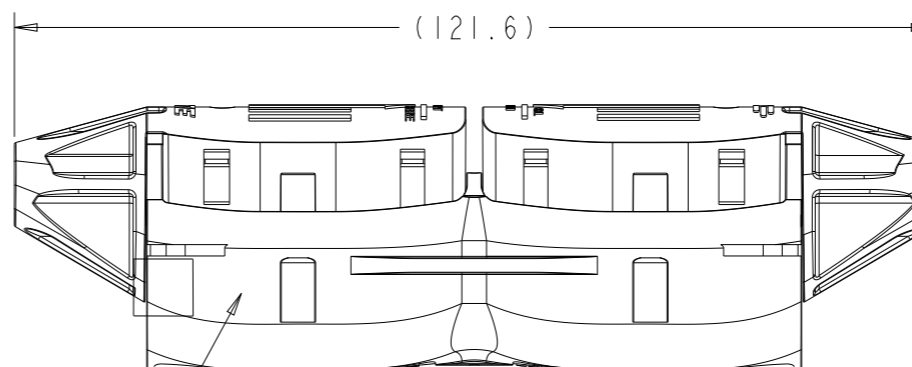
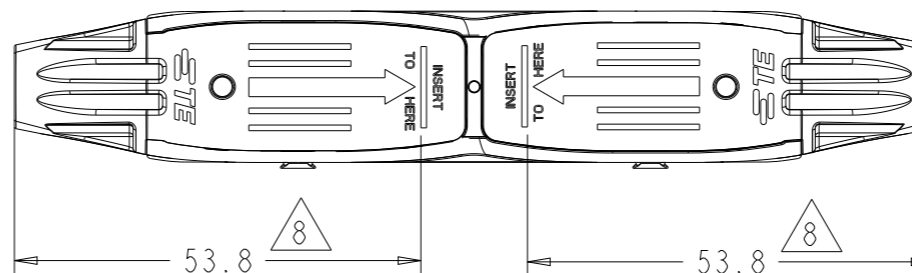
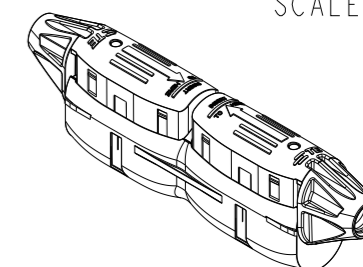

P/N 2336077-1 AS SHOWN
MODEL CODE: SLK-ID-1-BL-XX

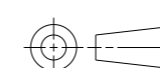

THIS DRAWING IS A CONTROLLED DOCUMENT.		DWN	29JUN2018		 TE Connectivity
		CHK	29JUN2018		
		APVD	29JUN2018		
		PRODUCT SPEC	108-133104		
DIMENSIONS:		TOLERANCES UNLESS OTHERWISE SPECIFIED:		NAME	
mm				SOLARLOK 2.0 - SPLICE	
		0 PLC ±0.4 1 PLC ±0.3 2 PLC ± 3 PLC ± 4 PLC ± ANGLES ± FINISH -		APPLICATION SPEC	
MATERIAL				114-133104	
				WEIGHT 48.4 gr	
				SIZE A3	
				CAGE CODE 00779	
				DRAWING NO C-2336077	
				RESTRICTED TO -	
		CUSTOMER DRAWING		SCALE 1:1	
				SHEET 1 OF 3	
				REV BI	

P	LTR	DESCRIPTION	DATE	DWN	APVD
-	-	SEE SHEET 1	-	-	-

DIMENSIONS AFTER APPLICATION

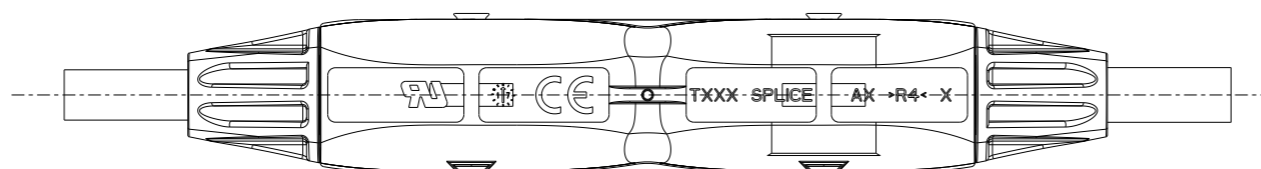
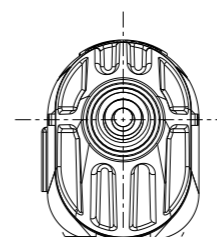
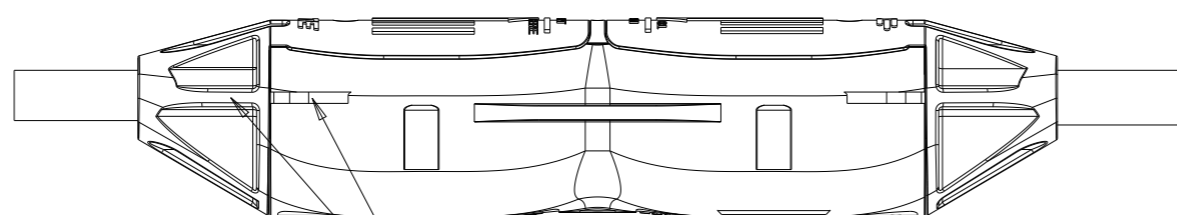
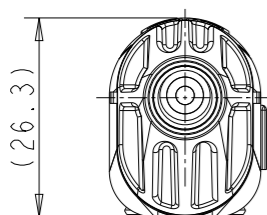
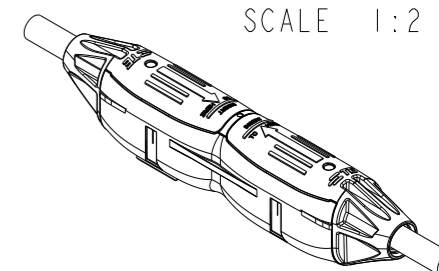
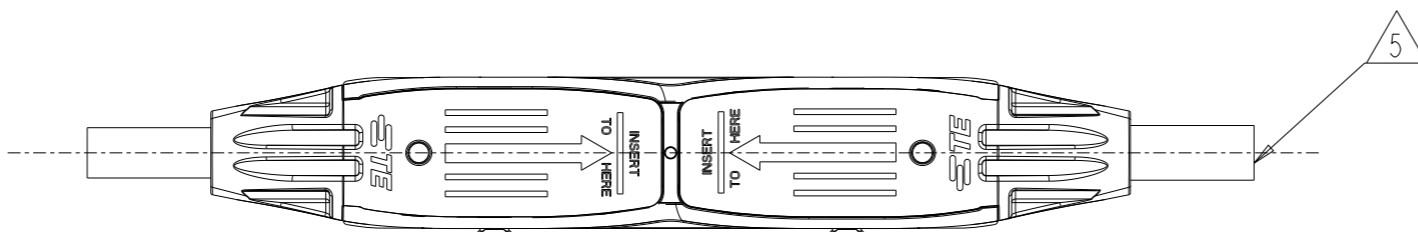
SCALE 1:2



THIS DRAWING IS A CONTROLLED DOCUMENT.		DWN GANESH C M 29JUN2018	 TE Connectivity	
DIMENSIONS: mm		CHK D FREDDY 29JUN2018		
TOLERANCES UNLESS OTHERWISE SPECIFIED:		APVD D FREDDY 29JUN2018	NAME SOLARLOK 2.0 - SPLICE	
0 PLC ±0.4 1 PLC ±0.3 2 PLC ± 3 PLC ± 4 PLC ± ANGLES ± FINISH -		PRODUCT SPEC 108-133104	RESTRICTED TO	
MATERIAL		APPLICATION SPEC 114-133104	SIZE A3	CAGE CODE 00779
		WEIGHT 48.4 gr	DRAWING NO C-2336077	REV B1
CUSTOMER DRAWING			SCALE 5:1	SHEET 2 OF 3

REVISIONS

P	LTR	DESCRIPTION	DATE	DWN	APVD
-	-	SEE SHEET 1	-	-	-

DIMENSIONS AFTER STACKING

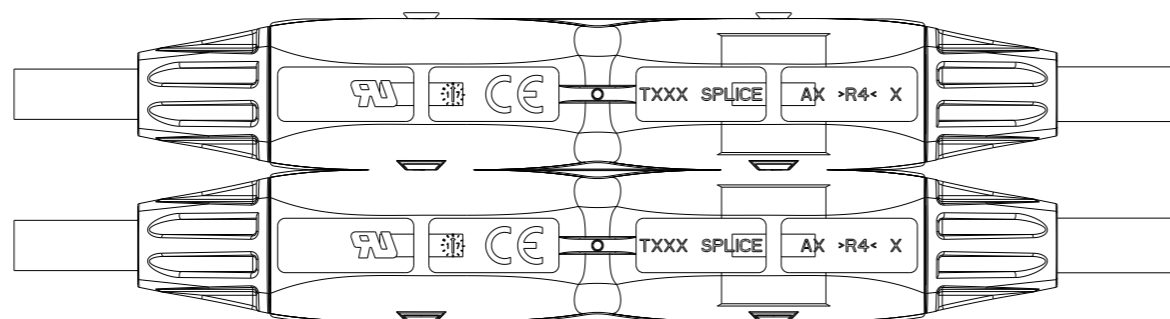
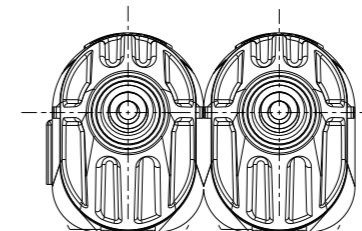
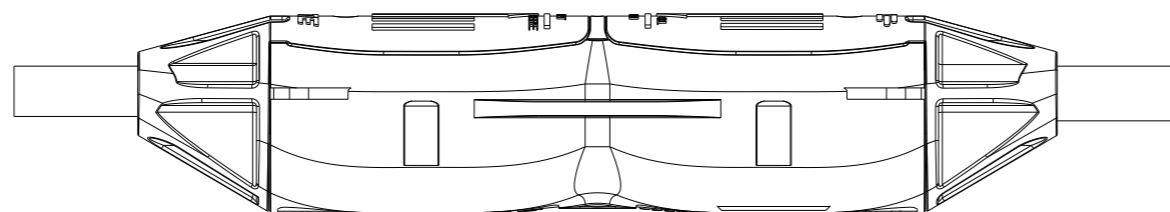
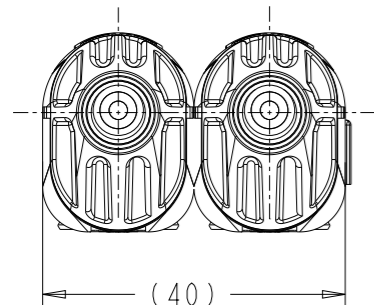
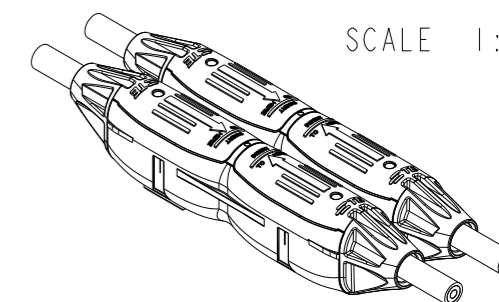
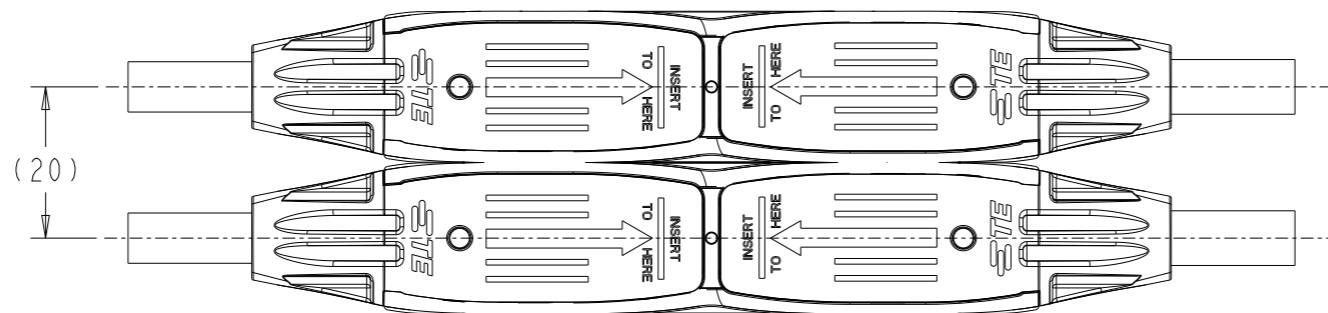

THIS DRAWING IS A CONTROLLED DOCUMENT.

DIMENSIONS:
mm

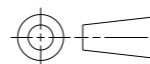

TOLERANCES UNLESS OTHERWISE SPECIFIED:

- 0 PLC ±0.4
- 1 PLC ±0.3
- 2 PLC ±-
- 3 PLC ±-
- 4 PLC ±-
- ANGLES ±-
- FINISH -

MATERIAL



DWN 29JUN2018

GANESH C M

CHK 29JUN2018

D FREDDY

APVD 29JUN2018

D FREDDY

PRODUCT SPEC

108-133104

APPLICATION SPEC

114-133104

WEIGHT

48.4 gr

CUSTOMER DRAWING



TE Connectivity

NAME SOLARLOK 2.0 - SPLICE

-

-

SIZE CAGE CODE DRAWING NO RESTRICTED TO

A3 00779 C-2336077 -

SCALE 1:1 SHEET 3 OF 3 REV B1