

REVISIONS				
REV.	ECO. NO	DESCRIPTION	DATE	BY
H	3499	ADD 02 AND 14 POSITION TO DIM TABLE	8/2/2016	MG
J	3951	ADD KEY IN POSITION & KEY BETWEEN POSITIONS OPTION	11/13/2018	JH
K	4391	ADD S# TABLE FOR BROWN PPS AND BLACK PBT WITH MOLDED KEY (S2853), ADD MTG ON DIM TABLE FOR 02, 03 POSI, ADD 32 POSITION	7/7/2021	JH

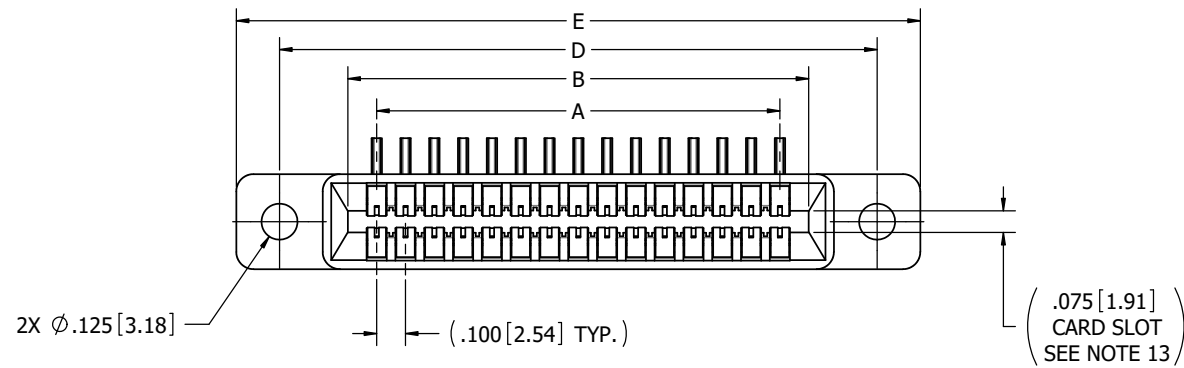

(.075 [1.91]
CARD SLOT
SEE NOTE 13)

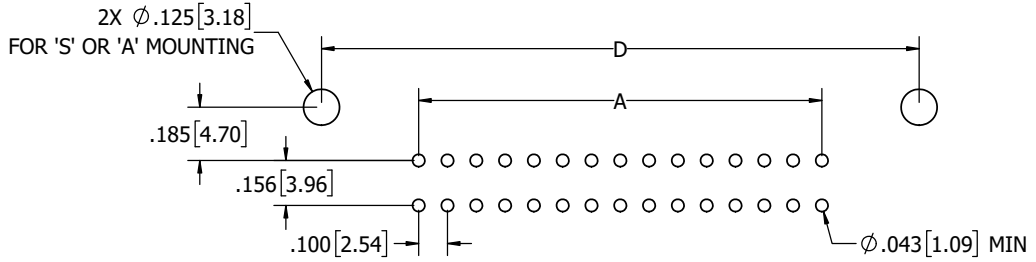
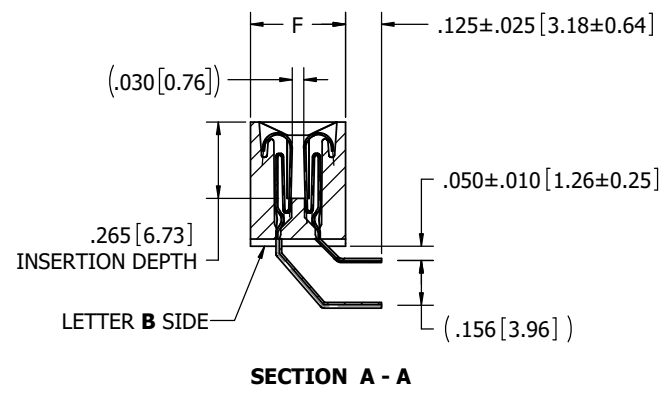
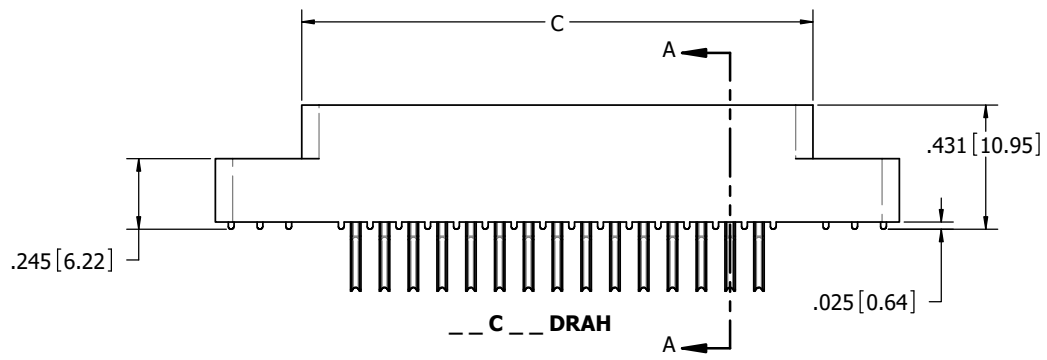

**PCB LAYOUT RECOMMENDED
(COMPONENT SIDE)**

SECTION A - A

CONTACT IDs:
B 1 2 3 ... 60 B
A 1 2 3 ... 60 A

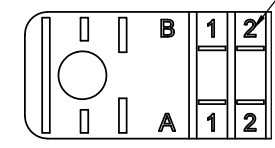

**CONTACT ID
SCALE 4:1
(PINS OMITTED FOR CLARITY)**

NOTES:

1. INSULATOR MATERIAL: SEE PART NUMBER CODING
2. CONTACT MATERIAL: SEE PART NUMBER CODING
3. PLATING: SEE PART NUMBER CODING
4. OPERATING TEMPERATURE: SEE PART NUMBER CODING
5. PROCESSING TEMP: SEE PART NUMBER CODING
6. UL FLAMMABILITY RATING: 94V-0
7. OPERATING VOLTAGE: 700 VAC
8. CURRENT RATING: 3 AMP
9. CONTACT RESISTANCE: 30 MILLI OHMS MAX
10. INSULATION RESISTANCE: 5000 MEGA OHMS
11. DURABILITY: 500 CYCLES MIN
12. CONNECTOR IDENTIFICATION: THE PART SHALL BE MARKED WITH A PART NUMBER AND LOT CODE
13. BOARD THICKNESS ACCOMMODATED: .062±.008 [1.57±0.20]
14. INSERTION FORCE: 16 OZ MAX PER CONTACT PAIR WHEN USING A .062 [1.57] TEST BLADE
INTERNAL INSPECTION TO BE PER SULLIN'S WORK INSTRUCTION WI7.3-01
15. WITHDRAWAL FORCE: 1 OZ MIN PER CONTACT PAIR USING .062 [1.57] TEST BLADE
16. MODIFICATION: SEE PART NUMBER CODING



RoHS COMPLIANT

UNLESS OTHERWISE SPECIFIED: DIMENSIONS ARE IN INCHES (MM)	DRAWN	DATE	NAME	
		01/19/07	MNH	
TOLERANCES: ANGULAR: ± 1° DECIMALS .XX = ± .02 [5] .XXX = ± .005 [13] .XXXX = ± .0005 [013]	<small>THE INFORMATION HEREIN CONTAINS PROPRIETARY INFORMATION OF SULLINS ELECTRONICS AND IS NOT TO BE REPRODUCED, USED OR DISCLOSED TO OTHERS FOR ANY PURPOSE EXCEPT AS SPECIFICALLY AUTHORIZED IN WRITING BY AN OFFICER OF SULLINS ELECTRONICS.</small>			
	TITLE EDGECARD, .100 CC LP			
	PART NUMBER C DRA (S38,S81,S328, S)			
	SIZE	CAGE CODE	DWG. NO.	REV
	C	54453	C10876	K
	SCALE: 3:1	SHEET 1 OF 4		

CUSTOMER COPY

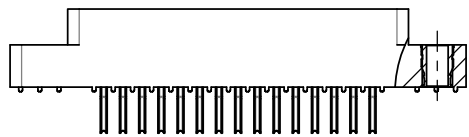
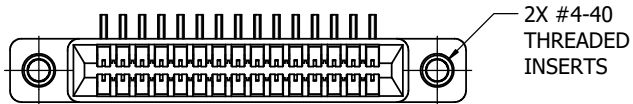

--- C --- DRAI

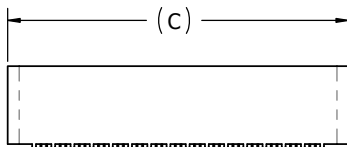
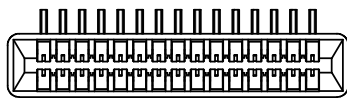

--- C --- DRAN

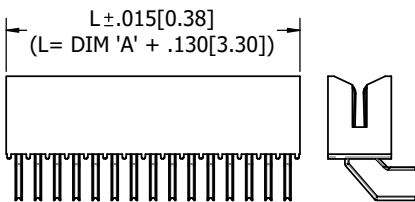
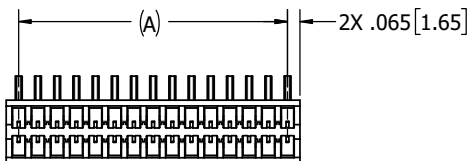

--- C --- DRAB

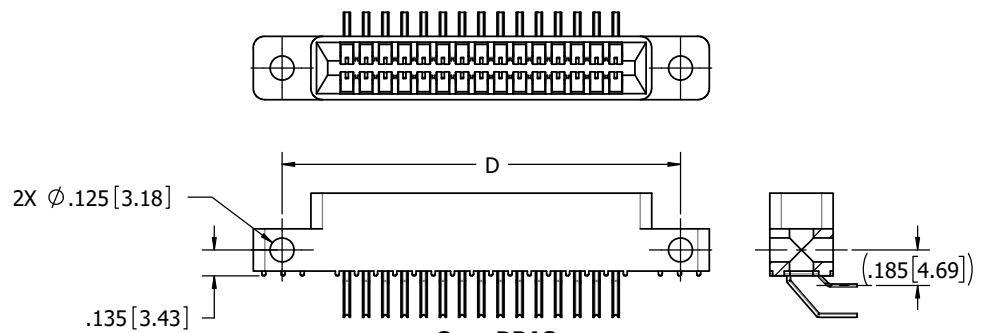

--- C --- DRAS

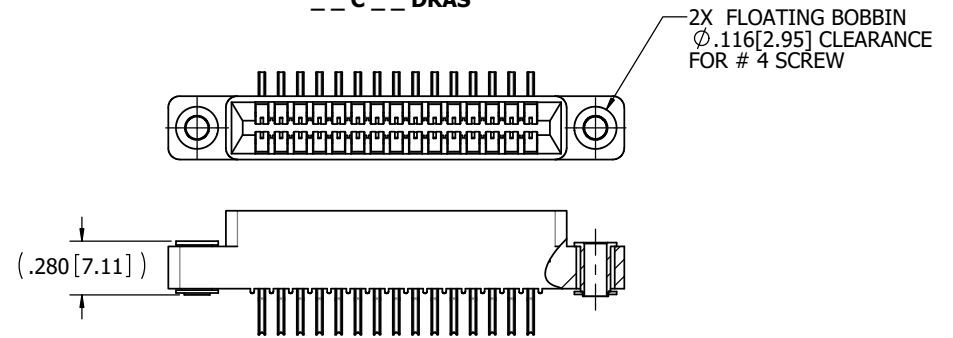

--- C --- DRAF

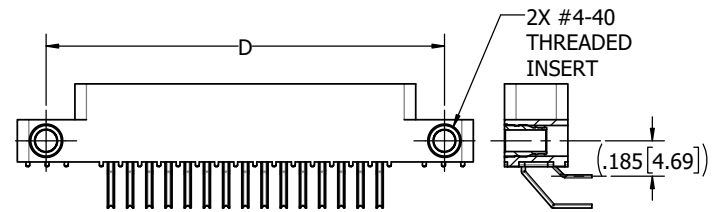
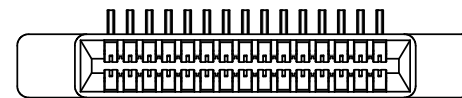

--- C --- DRAA

CUSTOMER COPY



UNLESS OTHERWISE SPECIFIED:
DIMENSIONS ARE IN INCHES [MM]

TOLERANCES:
ANGULAR: $\pm 1^\circ$
DECIMALS
.XX = $\pm .02$ [.5]
.XXX = $\pm .005$ [.13]
.XXXX = $\pm .0005$ [.013]

DRAWN	DATE	NAME
	01/19/07	MNH

THE INFORMATION HEREIN CONTAINS PROPRIETARY INFORMATION OF SULLINS ELECTRONICS AND IS NOT TO BE REPRODUCED, USED OR DISCLOSED TO OTHERS FOR ANY PURPOSE EXCEPT AS SPECIFICALLY AUTHORIZED IN WRITING BY AN OFFICER OF SULLINS ELECTRONICS.

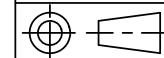

SULLINS CONNECTOR SOLUTIONS			
TITLE EDGECARD, .100 CC LP			
PART NUMBER --- C --- DRA (S38,S81,S328, S ---)			
SIZE C	CAGE CODE 54453	DWG. NO. C10876	REV K
SCALE: 2:1		SHEET 2 OF 4	

PART NUMBER	NO. OF POS.	A ±.008[0.20]		B ±.008[0.20]		C ±.015[0.38]		D ±.010[0.25]		E ±.020[0.51]		F ±.005/-0.015[+0.13/-0.38]	
		IN	MM	IN	MM	IN	MM	IN	MM	IN	MM	IN	MM
C02DRA -S	2	0.100	2.54	0.300	7.62	0.475	12.07	0.775	19.69	1.075	27.31		
C03DRA -S	3	0.200	5.08	0.400	10.16	0.575	14.61	0.875	22.23	1.175	29.85		
C04DRA -S	4	0.300	7.62	0.500	12.70	0.675	17.15	0.975	24.77	1.275	32.39		
C05DRA -S	5	0.400	10.16	0.600	15.24	0.775	19.69	1.075	27.31	1.375	34.93		
C06DRA -S	6	0.500	12.70	0.700	17.78	0.875	22.23	1.175	29.85	1.475	37.47		
C07DRA -S	7	0.600	15.24	0.800	20.32	0.975	24.77	1.275	32.39	1.575	40.01		
C08DRA -S	8	0.700	17.78	0.900	22.86	1.075	27.31	1.375	34.93	1.675	42.55		
C10DRA -S	10	0.900	22.86	1.100	27.94	1.275	32.39	1.575	40.01	1.875	47.63		
C12DRA -S	12	1.100	27.94	1.300	33.02	1.475	37.47	1.775	45.09	2.075	52.71		
C13DRA -S	13	1.200	30.48	1.400	35.56	1.575	40.01	1.875	47.63	2.175	55.25		
C14DRA -S	14	1.300	33.02	1.500	38.10	1.675	42.55	1.975	50.17	2.275	57.79		
C15DRA -S	15	1.400	35.56	1.600	40.64	1.775	45.09	2.075	52.71	2.375	60.33		
C17DRA -S	17	1.600	40.64	1.800	45.72	1.975	50.17	2.275	57.79	2.575	65.41	0.330	8.38
C18DRA -S	18	1.700	43.18	1.900	48.26	2.075	52.71	2.375	60.33	2.675	67.95		
C19DRA -S	19	1.800	45.72	2.000	50.80	2.175	55.25	2.475	62.87	2.775	70.49		
C20DRA -S	20	1.900	48.26	2.100	53.34	2.275	57.79	2.575	65.41	2.875	73.03		
C22DRA -S	22	2.100	53.34	2.300	58.42	2.475	62.87	2.775	70.49	3.075	78.11		
C23DRA -S	23	2.200	55.88	2.400	60.96	2.575	65.41	2.875	73.03	3.175	80.65		
C25DRA -S	25	2.400	60.96	2.600	66.04	2.775	70.49	3.075	78.11	3.375	85.73		
C26DRA -S	26	2.500	63.50	2.700	68.58	2.875	73.03	3.175	80.65	3.475	88.27		
C28DRA -S	28	2.700	68.58	2.900	73.66	3.075	78.11	3.375	85.73	3.675	93.35		
C30DRA -S	30	2.900	73.66	3.100	78.74	3.275	83.19	3.575	90.81	3.875	98.43		
C31DRA -S	31	3.000	76.20	3.200	81.28	3.375	85.73	3.675	93.35	3.975	100.97		
C32DRA -S	32	3.100	78.74	3.300	83.82	3.475	88.27	3.775	95.89	4.075	103.51		
C35DRA -S	35	3.400	86.36	3.600	91.44	3.775	95.89	4.075	103.51	4.375	111.13		
C36DRA -S	36	3.500	88.90	3.700	93.98	3.875	98.43	4.175	106.05	4.475	113.67		
C40DRA -S	40	3.900	99.06	4.100	104.14	4.275	108.59	4.575	116.21	4.875	123.83		
C43DRA -S	43	4.200	106.68	4.400	111.76	4.575	116.21	4.875	123.83	5.175	131.45		
C44DRA -S	44	4.300	109.22	4.500	114.30	4.675	118.75	4.975	126.37	5.275	133.99		
C45DRA -S	45	4.400	111.76	4.600	116.84	4.775	121.29	5.075	128.91	5.375	136.53		
C49DRA -S	49	4.800	121.92	5.000	127.00	5.175	131.45	5.475	139.07	5.775	146.69		
C50DRA -S	50	4.900	124.46	5.100	129.54	5.275	133.99	5.575	141.61	5.875	149.23		
C52DRA -S	52	5.100	129.54	5.300	134.62	5.475	139.07	5.775	146.69	6.075	154.31		
C60DRA -S	60	5.900	149.86	6.100	154.94	6.275	159.39	6.575	167.01	6.875	174.63		
C65DRA -S	65	6.400	162.56	6.600	167.64	6.775	172.09	7.075	179.71	7.375	187.33		

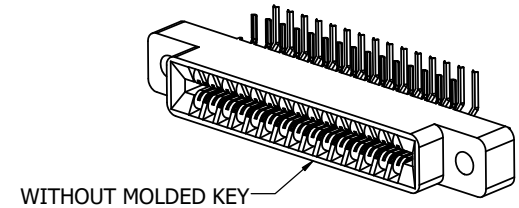

WITHOUT MOLDED KEY

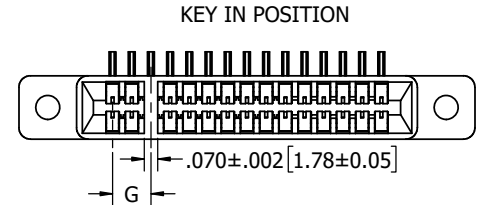

KEY IN POSITION



('H' MOUNTING AS SHOWN FOR EXAMPLE)

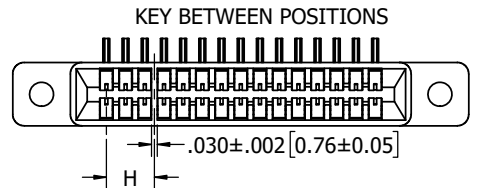

KEY BETWEEN POSITIONS

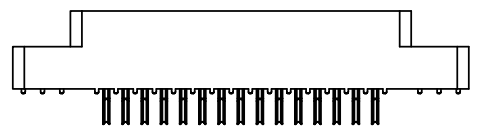

('H' MOUNTING AS SHOWN FOR EXAMPLE)

PART NUMBER CODING

C DRA -S

MATERIAL (INSULATOR/CONTACT)

E = BLUE PBT/PHOSPHOR BRONZE
OPERATING TEMP: -65°C TO +125°C
PROCESSING TEMP: WAVE/MANUAL SOLDERING ONLY

R = GREEN PPS/PHOSPHOR BRONZE
OPERATING TEMP: -65°C TO +125°C
PROCESSING TEMP: 260°C MAX FOR 20 SECS

G = BLACK PA9T/PHOSPHOR BRONZE
OPERATING TEMP: -65°C TO +125°C
PROCESSING TEMP: 260°C MAX FOR 20 SECS

H = BLUE PBT/BERYLLIUM COPPER
OPERATING TEMP: -65°C TO +125°C
PROCESSING TEMP: WAVE/MANUAL SOLDERING ONLY

A = GREEN PPS/BERYLLIUM COPPER
OPERATING TEMP: -65°C TO +150°C
PROCESSING TEMP: 260°C MAX FOR 20 SECS

J = BLACK PA9T/BERYLLIUM COPPER
OPERATING TEMP: -65°C TO +150°C
PROCESSING TEMP: 260°C MAX FOR 20 SECS

F = GREEN PPS/SPINODAL (CONSULT FACTORY)
OPERATING TEMP: -65°C TO +200°C
PROCESSING TEMP: 260°C MAX FOR 20 SECS
(CONSULT FACTORY FOR SPECIAL SOLDERING GUIDELINES)
AVAILABLE IN OVERALL GOLD ONLY (S OR M PLATING CODE)

C = GREEN PPS/BERYLLIUM NICKEL (CONSULT FACTORY)
OPERATING TEMP: -65°C TO +200°C
PROCESSING TEMP: 260°C MAX FOR 20 SECS
AVAILABLE IN OVERALL GOLD ONLY (S OR M PLATING CODE)

W = TAN PEEK/BERYLLIUM NICKEL (CONSULT FACTORY)
OPERATING TEMP: -65°C TO +250°C
PROCESSING TEMP: 260°C MAX FOR 20 SECS
AVAILABLE IN OVERALL GOLD ONLY (M PLATING CODE)

MODIFICATION

OMIT FOR STANDARD, EX: EBC15DRAH
S38 = BLACK PBT (MATERIAL CODES E AND H ONLY)
S81 = GREEN PBT (MATERIAL CODES E AND H ONLY)
S328 = BROWN PPS (MATERIAL CODES R, A, F, C ONLY)
SEE DRAWING C13556 FOR S#, G & H DIMENSIONS FOR STANDARD COLOR WITH MOLDED KEY
SEE PAGE 4 FOR S# FOR BROWN PPS AND BLACK PBT WITH MOLDED KEY

MOUNTING STYLE

H = .125" DIA. CLEARANCE HOLES
I = #4-40 THREADED INSERT
S = .125" DIA. SIDE MOUNTING
N = NO MOUNTING EARS
F = FLOATING BOBBIN
B = OPEN CARD SLOT
A = #4-40 THREADED INSERT IN SIDE HOLES

PLATING

ALL PLATINGS ARE LEAD FREE AND HAVE .000050" NICKEL UNDERPLATE

CONTACT SURFACE TERMINATION

B = .000010" GOLD .000100" PURE TIN, MATTE
C = .000030" GOLD .000100" PURE TIN, MATTE
G = .000010" GOLD .000005" GOLD
Y = .000030" GOLD .000005" GOLD
**E = .000100" PURE TIN, MATTE .000100" PURE TIN, MATTE, OVERALL
S = .000010" GOLD .000010" GOLD OVERALL
M = .000030" GOLD .000010" GOLD OVERALL
** OVERALL TIN ONLY AVAILABLE ON MATERIAL CODES E, R AND G



RoHS COMPLIANT

UNLESS OTHERWISE SPECIFIED:
DIMENSIONS ARE IN INCHES (MM)

TOLERANCES:
ANGULAR: ± 1°
DECIMALS
XX = ± .02 [5]
XXX = ± .005 [13]
XXXX = ± .0005 [0.13]

DRAWN	DATE	NAME		
	01/19/07	MNH		
<small>THE INFORMATION HEREIN CONTAINS PROPRIETARY INFORMATION OF SULLINS ELECTRONICS AND IS NOT TO BE REPRODUCED, USED OR DISCLOSED TO OTHERS FOR ANY PURPOSE EXCEPT AS SPECIFICALLY AUTHORIZED IN WRITING BY AN OFFICER OF SULLINS ELECTRONICS.</small>			TITLE	
			EDGE CARD, .100 CC LP	
			PART NUMBER	
			C DRA (S38,S81,S328, S)	
SIZE	CAGE CODE	DWG. NO.	REV	
C	54453			K
SCALE: 2:1			SHEET 3 OF 4	

CUSTOMER COPY

MOLDED KEY/SLOT IN POSITION	MODIFICATION NUMBER (S#)	
	BROWN PPS	BLACK PBT
01		
02		
03		
04		
05	S1871	
06	S2853	
07		
08	S1151	
09		
10		
11		
12	S1500	
13		
14	S1013	
15		
16		
17		
18		
19		
20		
21		
22		
23		
24		
25		
26		
27		
28		
29		
30		
31		
32		
33		
34		
35		
36		
37		
38		
39		
40		
41		
42		
43		
44		
45		
46	S1809	
47		
48		
49		
50		

MOLDED KEY/SLOT BETWEEN POSITIONS	MODIFICATION NUMBER (S#)	
	BROWN PPS	BLACK PBT
1&2	S1991	
2&3		
3&4		
4&5		
5&6	S2796	S2167
6&7		
7&8		
8&9		
9&10		
10&11		
11&12		
12&13		
13&14		
14&15		
15&16		
16&17		
17&18		
18&19		
19&20		
20&21		
21&22		
22&23		
23&24		
24&25		
25&26		
26&27		
27&28		
28&29		
29&30		
30&31		
31&32		
32&33		
33&34		
34&35		
35&36		
36&37		
37&38		
38&39		
39&40		
40&41		
41&42		
42&43		
43&44		
44&45		
45&46		
46&47		
47&48		
48&49		
49&50		

CUSTOMER COPY

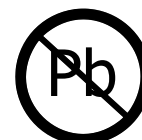

RoHS COMPLIANT

UNLESS OTHERWISE SPECIFIED:
DIMENSIONS ARE IN INCHES (MM)

TOLERANCES:
ANGULAR: ± 1°

DECIMALS
.XX = ± .02 [5]
.XXX = ± .005 [13]
.XXXX = ± .0005 [013]

DRAWN	DATE	NAME
	01/19/07	MNH
<small>THE INFORMATION HEREIN CONTAINS PROPRIETARY INFORMATION OF SULLINS ELECTRONICS AND IS NOT TO BE REPRODUCED, USED OR DISCLOSED TO OTHERS FOR ANY PURPOSE EXCEPT AS SPECIFICALLY AUTHORIZED IN WRITING BY AN OFFICER OF SULLINS ELECTRONICS.</small>		

TITLE			
EDGE CARD, .100 CC LP			
PART NUMBER			
C DRA -S			
SIZE	CAGE CODE	DWG. NO.	REV
C	54453	C10876	K
SCALE: 3:1			SHEET 4 OF 4