



GRTE18S-P2312

GR18S

CYLINDRICAL PHOTOELECTRIC SENSORS

SICK
Sensor Intelligence.



Ordering information

Type	Part no.
GRTE18S-P2312	1058204

Other models and accessories → www.sick.com/GR18S

Illustration may differ



Detailed technical data

Features

Sensor/ detection principle	Photoelectric proximity sensor, Energetic
Housing design (light emission)	Cylindrical
Thread diameter (housing)	M18 x 1
Optical axis	Axial
Sensing range max.	3 mm ... 115 mm ¹⁾
Sensing range	5 mm ... 100 mm ¹⁾
Type of light	Visible red light
Light source	PinPoint LED ²⁾
Light spot size (distance)	Ø 8 mm (100 mm)
Wave length	650 nm
Adjustment	Potentiometer, 270°

¹⁾ Object with 90 % reflectance (referred to standard white, DIN 5033).

²⁾ Average service life: 100,000 h at T_U = +25 °C.

Mechanics/electronics

Supply voltage	10 V DC ... 30 V DC ¹⁾
Ripple	± 5 V _{pp} ²⁾
Power consumption	30 mA

¹⁾ Limit values. Operated in short-circuit protected network: max. 8 A.

²⁾ May not exceed or fall below U_v tolerances.

³⁾ At U_v > 24 V or ambient temperature > 49 °C, I_A max. = 50 mA.

⁴⁾ Signal transit time with resistive load.

⁵⁾ With light/dark ratio 1:1.

⁶⁾ A = V_S connections reverse-polarity protected.

⁷⁾ B = inputs and output reverse-polarity protected.

⁸⁾ D = outputs overcurrent and short-circuit protected.

⁹⁾ At U_v ≤ 24V and I_A < 50mA.

Switching output	PNP
Switching mode	Light switching
Signal voltage PNP HIGH/LOW	$V_S - (\leq 3 \text{ V}) / \text{approx. } 0 \text{ V}$
Output current I_{max}	100 mA ³⁾
Response time	< 1,000 μs ⁴⁾
Switching frequency	500 Hz ⁵⁾
Connection type	Connector M12, 3-pin
Circuit protection	A ⁶⁾ B ⁷⁾ D ⁸⁾
Protection class	III
Housing material	Metal, Nickel-plated brass and ABS
Optics material	Plastic, PMMA
Enclosure rating	IP67
Items supplied	Fastening nuts (2 x)
EMC	EN 60947-5-2
Ambient operating temperature	-25 °C ... +55 °C ⁹⁾
Ambient storage temperature	-40 °C ... +70 °C
UL File No.	NRKH.E348498 & NRKH7.E348498

¹⁾ Limit values. Operated in short-circuit protected network: max. 8 A.

²⁾ May not exceed or fall below U_V tolerances.

³⁾ At $U_V > 24 \text{ V}$ or ambient temperature > 49 °C, $I_A \text{ max.} = 50 \text{ mA}$.

⁴⁾ Signal transit time with resistive load.

⁵⁾ With light/dark ratio 1:1.

⁶⁾ A = V_S connections reverse-polarity protected.

⁷⁾ B = inputs and output reverse-polarity protected.

⁸⁾ D = outputs overcurrent and short-circuit protected.

⁹⁾ At $U_V \leq 24 \text{ V}$ and $I_A < 50 \text{ mA}$.

Safety-related parameters

MTTF_D	1,930 years
DC_{avg}	0%

Classifications

ECI@ss 5.0	27270903
ECI@ss 5.1.4	27270903
ECI@ss 6.0	27270903
ECI@ss 6.2	27270903
ECI@ss 7.0	27270903
ECI@ss 8.0	27270903
ECI@ss 8.1	27270903
ECI@ss 9.0	27270903
ETIM 5.0	EC001821
ETIM 6.0	EC001821
UNSPSC 16.0901	39121528

Adjustments possible

GRTB18(S), GRTE18(S), Sensing range setting: Potentiometer, 270°

Sensing range

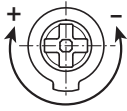

Connection diagram

Cd-045

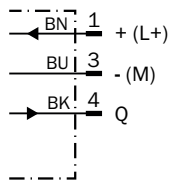

Characteristic curve

GRTE18S, 100 mm

Operating reserve

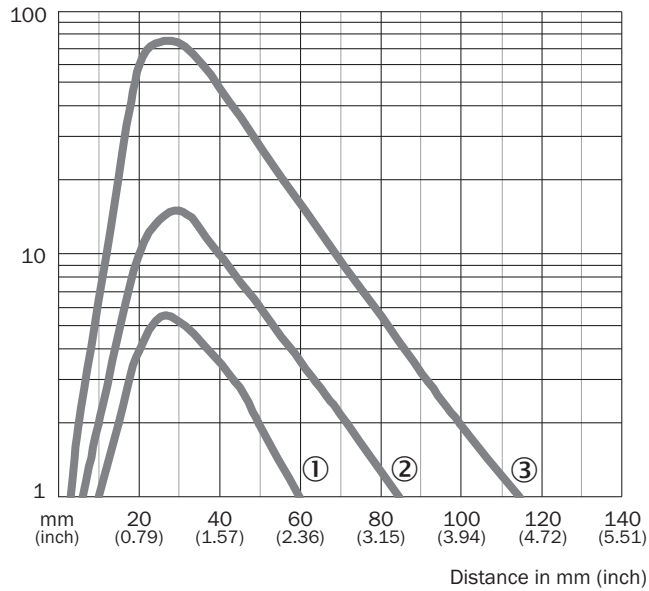

- ① Sensing range on black, 6% remission
- ② Sensing range on gray, 20 % remission
- ③ Sensing range on white, 90% remission

Light spot size

GRTE18S, 100 mm

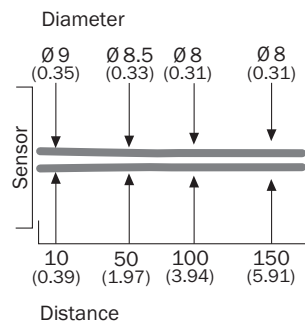

Dimensions in mm (inch)

Sensing range diagram

GRTE18S, 100 mm

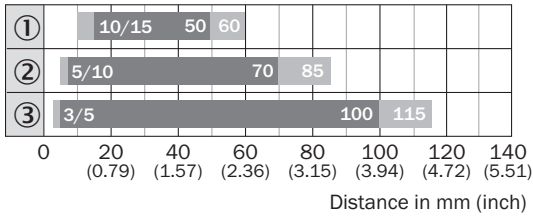

- Sensing range ■ Sensing range max.
- ① Sensing range on black, 6% remission
- ② Sensing range on gray, 20 % remission
- ③ Sensing range on white, 90% remission

Dimensional drawing (Dimensions in mm (inch))



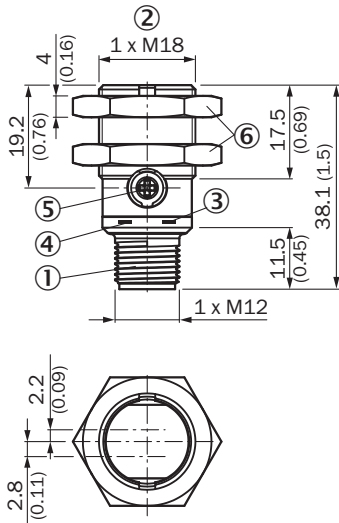



GR18S, metal, connector, straight, adjustable



- ① Connector M12, 3-pin
- ② Threaded mounting hole M18 x 1
- ③ LED indicator yellow
- ④ LED indicator green
- ⑤ Sensitivity control: potentiometer 270°
- ⑥ Fastening nuts (2x); width across 24, metal

Recommended accessories

Other models and accessories → www.sick.com/GR18S

	Brief description	Type	Part no.
Plug connectors and cables			
	Head A: female connector, M12, 4-pin, straight, A-coded Head B: Flying leads Cable: Sensor/actuator cable, PVC, unshielded, 2 m	YF2A14-020VB3XLEAX	2096234
	Head A: female connector, M12, 4-pin, straight, A-coded Head B: Flying leads Cable: Sensor/actuator cable, PVC, unshielded, 5 m	YF2A14-050VB3XLEAX	2096235
	Head A: female connector, M12, 4-pin, angled, A-coded Head B: Flying leads Cable: Sensor/actuator cable, PVC, unshielded, 2 m	YG2A14-020VB3XLEAX	2095895
	Head A: female connector, M12, 4-pin, angled, A-coded Head B: Flying leads Cable: Sensor/actuator cable, PVC, unshielded, 5 m	YG2A14-050VB3XLEAX	2095897
	Head A: female connector, M12, 4-pin, straight Head B: - Cable: unshielded	DOS-1204-G	6007302
	Head A: female connector, M12, 4-pin, angled Head B: - Cable: unshielded	DOS-1204-W	6007303
	Head A: male connector, M12, 4-pin, straight Head B: - Cable: unshielded	STE-1204-G	6009932
	Head A: male connector, M12, 4-pin, angled Head B: - Cable: unshielded	STE-1204-W	6022084

SICK AT A GLANCE

SICK is one of the leading manufacturers of intelligent sensors and sensor solutions for industrial applications. A unique range of products and services creates the perfect basis for controlling processes securely and efficiently, protecting individuals from accidents and preventing damage to the environment.

We have extensive experience in a wide range of industries and understand their processes and requirements. With intelligent sensors, we can deliver exactly what our customers need. In application centers in Europe, Asia and North America, system solutions are tested and optimized in accordance with customer specifications. All this makes us a reliable supplier and development partner.

Comprehensive services complete our offering: SICK LifeTime Services provide support throughout the machine life cycle and ensure safety and productivity.

For us, that is “Sensor Intelligence.”

WORLDWIDE PRESENCE:

Contacts and other locations –www.sick.com