











Surge suppressor (RC element) for 3RT1 S6, S10, S12 with spring-type terminal (drive) 48...127 V AC, 70...150 V DC



General technical data		
product brand name		SIRIUS
product designation		surge suppressor
design of the surge suppressor		with RC elements
Control circuit/ Control		
type of voltage of the control supply voltage		AC/DC
control supply voltage frequency		
• 1 rated value	Hz	50
• 2 rated value	Hz	60
control supply voltage 1		
• at DC	V	70 ... 150
• at AC		
— at 50 Hz	V	48 ... 127
— at 60 Hz	V	127 ... 48
Certificates/ approvals		
certificate of suitability		CE / UL / CSA
General Product Approval	EMC	Declaration of Conformity
	<a href="#">Confirmation</a>	
		
		
		
Declaration of Conformity	Test Certificates	Marine / Shipping
	<a href="#">Special Test Certificate</a>	
		
		
		
other	Railway	
<a href="#">Confirmation</a>	<a href="#">Miscellaneous</a>	<a href="#">Special Test Certificate</a>

## Further information

Information- and Downloadcenter (Catalogs, Brochures,...)

<https://www.siemens.com/ic10>

Industry Mall (Online ordering system)

<https://mall.industry.siemens.com/mall/en/en/Catalog/product?mlfb=3RT1956-1CC02>

Cax online generator

<http://support.automation.siemens.com/WW/CAXorder/default.aspx?lang=en&mlfb=3RT1956-1CC02>

Service&Support (Manuals, Certificates, Characteristics, FAQs,...)

<https://support.industry.siemens.com/cs/ww/en/ps/3RT1956-1CC02>

Image database (product images, 2D dimension drawings, 3D models, device circuit diagrams, EPLAN macros, ...)

[http://www.automation.siemens.com/bilddb/cax\\_de.aspx?mlfb=3RT1956-1CC02&lang=en](http://www.automation.siemens.com/bilddb/cax_de.aspx?mlfb=3RT1956-1CC02&lang=en)

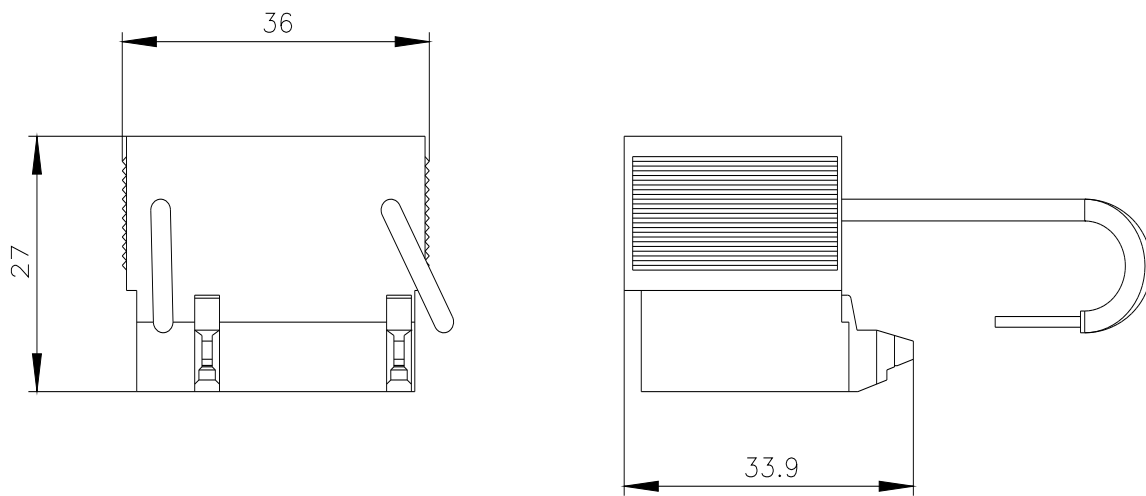

last modified:

4/21/2021 