

Dimensions: [mm]

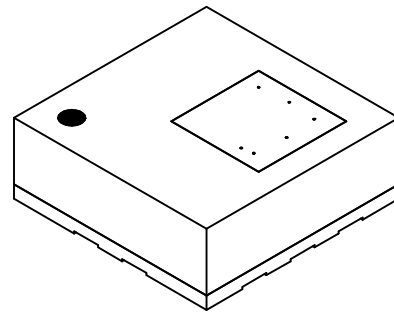

Scale - 18:1

Recommended Land Pattern: [mm] (Top View)

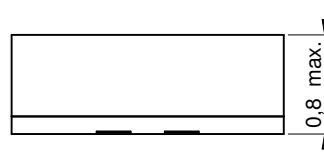
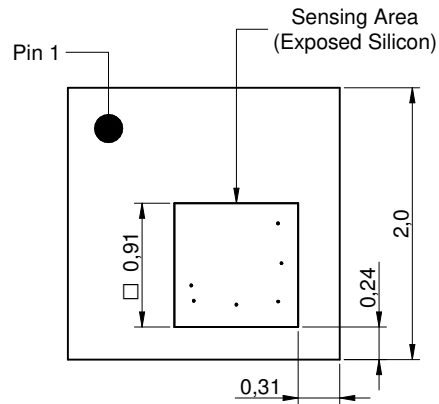
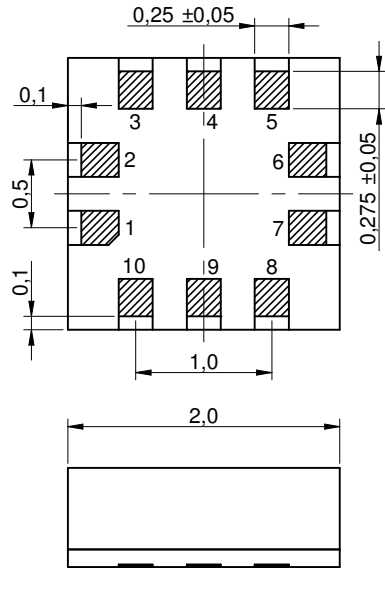
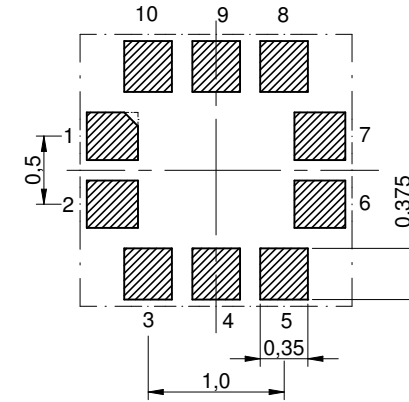

Scale - 18:1

Product Specific Pinning: (Top View)

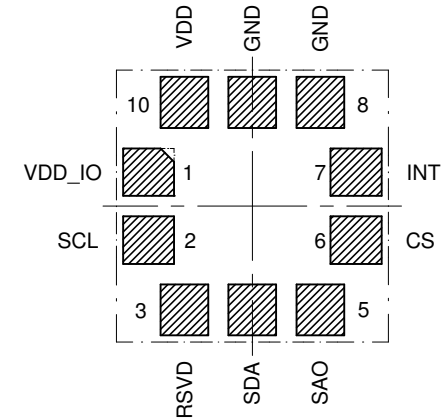

Scale - 18:1



**WÜRTH
ELEKTRONIK**
MORE THAN
YOU EXPECT

Würth Elektronik eiSos GmbH & Co. KG
EMC & Inductive Solutions
Max-Eyth-Str. 1
74638 Waldenburg
Germany
Tel. +49 (0) 79 42 945 - 0
www.we-online.com
eiSos@we-online.com

CHECKED NMe	REVISION 001.001	DATE (YYYY-MM-DD) 2020-11-20	GENERAL TOLERANCE DIN ISO 2768-1m	PROJECTION METHOD
DESCRIPTION WSEN-PADS Absolute Pressure Sensor			ORDER CODE 2511020213301	
BUSINESS UNIT eiSos		STATUS Valid	PAGE 1/7	

Pressure Sensor Specification:

Properties		Test conditions	Value			Unit
			min.	typ.	max.	
Measurement range	P _{RANGE}		26		126	kPa
Absolute accuracy	P _{ACC_ABS}	T = -20 to 80°C Including solder effects		±100 Pa		
Relative accuracy	P _{ACC_REL}	P = 80 to 110 kPa T = 25 °C		±2.5 Pa		
Sensitivity (digital)	SEN _P			1/40960 kPa/ digit		
Output data rate	ODR		1		200	Hz
Noise (RMS)	P _{NOISE}	Embedded filter enabled		0.75		Pa RMS
Offset change over temperature	P _{TCO}	P = 66 to 116 kPa T = -20 to 65 °C		±0.65 Pa/ °C		
Resolution (ADC)	RES _P			24		bits
Long term drift	P _{DRIFT}			±33 Pa/ Year		

Temperature Sensor Specification:

Properties		Test conditions	Value			Unit
			min.	typ.	max.	
Measurement range	T _{RANGE}		-40		85	°C
Absolute Accuracy	T _{ACC_ABS}	T = 0 to 80 °C		±1.5 °C		
Resolution	RES _T			16		bits
Sensitivity	SEN _T			0.01		°C/ digit

Electrical Properties:

Properties		Test conditions	Value			Unit
			min.	typ.	max.	
Operating supply voltage	V _{DD}		1.7	3.3	3.6	V
Operating supply voltage for I/O pins	V _{DD_IO}		1.7 V		V _{DD} +0.1 V	

Electrical Properties:

Properties		Test conditions	Value			Unit
			min.	typ.	max.	
Current consumption in low power mode	I _{DD_LP}	ODR = 1 Hz		4		µA
Current consumption in low noise mode	I _{DD_LN}	ODR = 1 Hz		12		µA
Current consumption in power down mode	I _{DD_PD}			0.9		µA
Digital input voltage - high-level	V _{IH}		0.8 * V _{DD_IO}			
Digital input voltage - low-level	V _{IL}				0.2 * V _{DD_IO}	
Digital output voltage - high-level	V _{OH}		V _{DD_IO} -0.2 V			
Digital output voltage - low-level	V _{OL}				0.2 V	V

Absolute Maximum Ratings:

Properties		Value		Unit
		min.	max.	
Input voltage VDD pin	V _{DD}	-0.3	4.8	V
Input voltage VDD_IO pin	V _{DD_IO}	-0.3	4.8	V
Input voltage control pins ¹⁾	V _{IN}	-0.3 V	V _{DD} +0.3 V	
Over pressure	P _{OVER}		2	MPa

¹⁾ SDA, SCL, CS & SA0 are control pins. Input voltage on any pin should never exceed 4.8 V

General Information:

Operating Temperature	-40 up to +85 °C
Storage Conditions (in original packaging)	< 40 °C ; < 90 % RH
Communication interface	I ² C, SPI
Moisture Sensitivity Level (MSL)	3



**WURTH
ELEKTRONIK**
MORE THAN
YOU EXPECT

Würth Elektronik eiSos GmbH & Co. KG
EMC & Inductive Solutions
Max-Eyth-Str. 1
74638 Waldenburg
Germany
Tel. +49 (0) 79 42 945 - 0
www.we-online.com
eiSos@we-online.com

CHECKED NMe	REVISION 001.001	DATE (YYYY-MM-DD) 2020-11-20	GENERAL TOLERANCE DIN ISO 2768-1m	PROJECTION METHOD
DESCRIPTION WSEN-PADS Absolute Pressure Sensor				ORDER CODE 2511020213301
BUSINESS UNIT eiSos		STATUS Valid	PAGE 2/7	

General Information:





Electrostatic discharge protection (HBM)	2.5 kV
--	--------

Product Specific Pinning:

Pin	Pad	Description	I/O
VDD_IO	1	Positive supply voltage for I/O pins	Supply
SCL	2	I ² C/SPI serial clock	Input
RSVD	3	Reserved (connect to ground)	Input
SDA	4	I ² C serial data; SPI serial data Input	Input/Output
SAO	5	I ² C device address selection; SPI serial data output	Input/Output
CS	6	I ² C enable/disable; SPI chip select pin	Input
INT	7	Interrupt	Input/Output
GND	8	Negative supply voltage	Supply
GND	9	Negative supply voltage	Supply
VDD	10	Positive supply voltage	Supply

Certification:

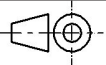
RoHS Approval	Compliant [2011/65/EU&2015/863]
REACH Approval	Conform or declared [(EC)1907/2006]

  	CHECKED NMe	REVISION 001.001	DATE (YYYY-MM-DD) 2020-11-20	GENERAL TOLERANCE DIN ISO 2768-1m	PROJECTION METHOD 	
	DESCRIPTION WSEN-PADS Absolute Pressure Sensor				ORDER CODE 2511020213301	
 WURTH ELEKTRONIK MORE THAN YOU EXPECT	Würth Elektronik eiSos GmbH & Co. KG EMC & Inductive Solutions Max-Eyth-Str. 1 74638 Waldenburg Germany Tel. +49 (0) 79 42 945 - 0 www.we-online.com eiSos@we-online.com			BUSINESS UNIT eiSos	STATUS Valid	PAGE 3/7

Packaging Specification - Tape and Reel: [mm]

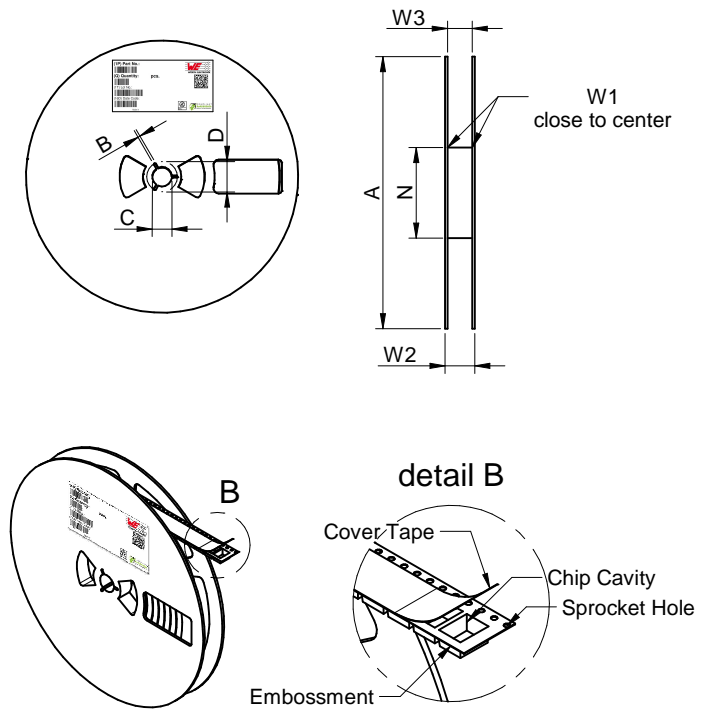
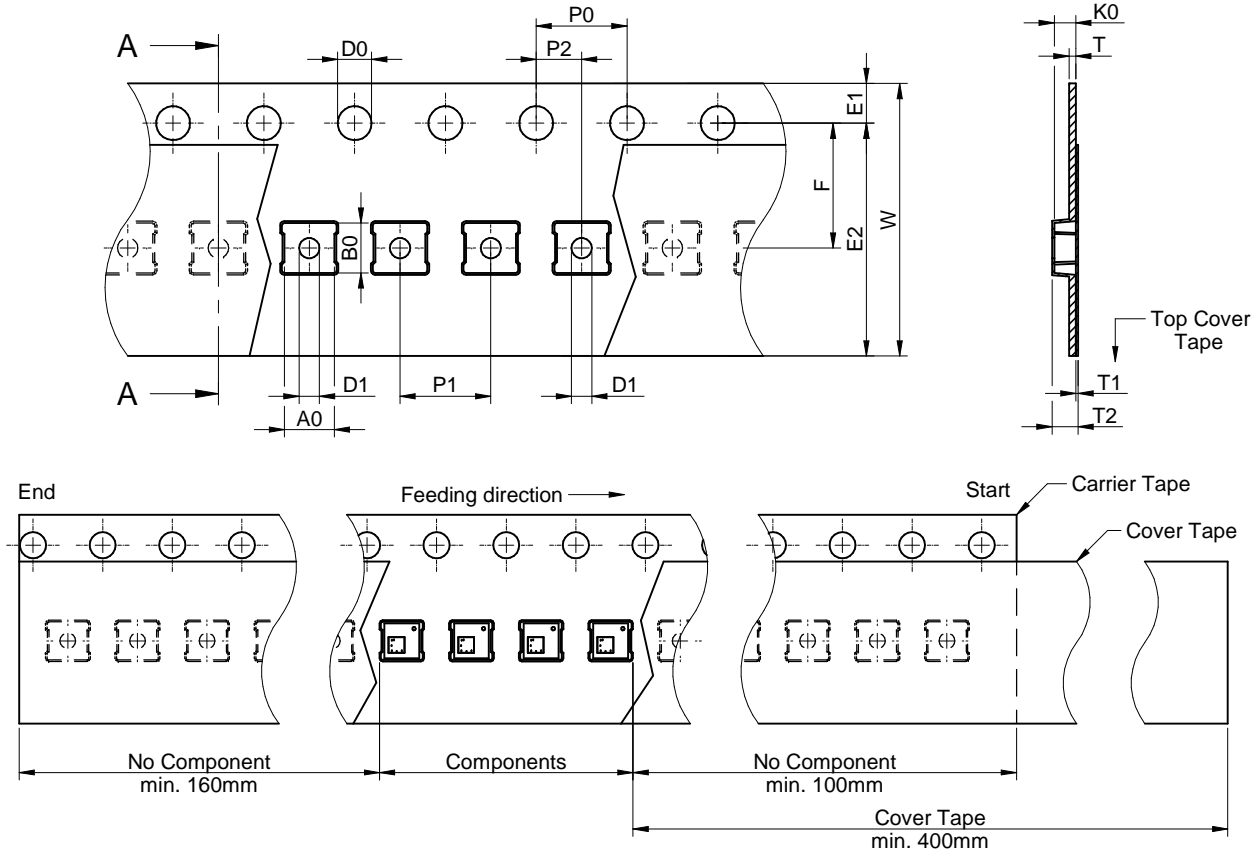

Packaging is referred to the international standard IEC 60286-3:2013

Tape Type	A0 (mm)	B0 (mm)	W (mm)	T (mm)	T1 (mm)	T2 (mm)	K0 (mm)	P0 (mm)	P1 (mm)	P2 (mm)	D0 (mm)	D1 (mm)	E1 (mm)	E2 (mm)	F (mm)	Material	Qty. (pcs.)
	±0,05	±0,05	+0,3/-0,1	±0,05	ref.	typ.	typ.	±0,1	±0,1	±0,05	+0,1/-0,0	min.	±0,1	min.	±0,05		
2a	2,20	2,20	12,00	0,25	0,10	1,20	0,95	4,00	4,00	2,00	1,50	1,50	1,75	10,25	5,50	Polystyrene	1000

A (mm)	B (mm)	C (mm)	D (mm)	N (mm)	W1 (mm)	W2 (mm)	W3 (mm)	W3 (mm)	Material
± 2,0	min.	min.	min.	min.	+ 2,0	max.	min.	max.	
178,00	1,50	12,80	20,20	50,00	12,40	18,40	15,90	19,40	Polystyrene



Tape width	12 mm	Pull-of force	0,1 N - 1,3 N
------------	-------	---------------	---------------



WURTH ELEKTRONIK
MORE THAN YOU EXPECT

Würth Elektronik eiSos GmbH & Co. KG
EMC & Inductive Solutions
Max-Eyth-Str. 1
74638 Waldenburg
Germany
Tel. +49 (0) 79 42 945 - 0
www.we-online.com
eiSos@we-online.com

CHECKED NMe	REVISION 001.001	DATE (YYYY-MM-DD) 2020-11-20	GENERAL TOLERANCE DIN ISO 2768-1m	PROJECTION METHOD
DESCRIPTION WSEN-PADS Absolute Pressure Sensor			ORDER CODE 2511020213301	
BUSINESS UNIT eiSos		STATUS Valid	PAGE 4/7	

Classification Reflow Profile for SMT components:



Classification Reflow Soldering Profile:

Profile Feature		Value
Preheat Temperature Min	$T_{s \text{ min}}$	150 °C
Preheat Temperature Max	$T_{s \text{ max}}$	200 °C
Preheat Time t_s from $T_{s \text{ min}}$ to $T_{s \text{ max}}$	t_s	60 - 120 seconds
Ramp-up Rate (T_L to T_p)		3 °C/ second max.
Liquidous Temperature	T_L	217 °C
Time t_L maintained above T_L	t_L	60 - 150 seconds
Peak package body temperature	T_p	260 °C
Time within 5°C of actual peak temperature	t_p	20 - 30 seconds
Ramp-down Rate (T_p to T_L) ¹⁾		6 °C/ second max.
Time 25°C to peak temperature		8 minutes max.

¹⁾ In order to reduce residual stress on the sensor components, the recommended ramp-down temperature slope should not exceed 3°C/sec. refer to IPC/ JEDEC J-STD-020E



WÜRTH ELEKTRONIK
MORE THAN YOU EXPECT

Würth Elektronik eiSos GmbH & Co. KG
EMC & Inductive Solutions
Max-Eyth-Str. 1
74638 Waldenburg
Germany
Tel. +49 (0) 79 42 945 - 0
www.we-online.com
eiSos@we-online.com

CHECKED NMe	REVISION 001.001	DATE (YYYY-MM-DD) 2020-11-20	GENERAL TOLERANCE DIN ISO 2768-1m	PROJECTION METHOD
DESCRIPTION WSEN-PADS Absolute Pressure Sensor			ORDER CODE 2511020213301	
BUSINESS UNIT eiSos		STATUS Valid	PAGE 5/7	

Cautions and Warnings:

The following conditions apply to all goods within the product series of sensor components of Würth Elektronik eiSos GmbH & Co. KG:

General:

- This electronic component is designed and manufactured for use in general electronic equipment.
- Würth Elektronik must be asked for written approval (following the PPAP procedure) before incorporating the components into any equipment in fields such as military, aerospace, aviation, nuclear control, submarine, transportation (automotive control, train control, ship control), transportation signal, disaster prevention, medical, public information network, etc. where higher safety and reliability are especially required and/or if there is the possibility of direct damage or human injury.
- Electronic components that will be used in safety-critical or high-reliability applications, shall be pre-evaluated by the customer.
- The component is designed and manufactured to be used within the datasheet specified values. If the usage and operation conditions specified in the datasheet are not met, the wire insulation may be damaged or dissolved.
- Do not drop or impact the components, the component may be damaged
- Würth Elektronik products are qualified according to international standards, which are listed in each product reliability report. Würth Elektronik does not warrant any customer qualified product characteristics beyond Würth Elektronik's specifications, for its validity and sustainability over time.
- The responsibility for the applicability of the customer specific products and use in a particular customer design is always within the authority of the customer. All technical specifications for standard products also apply to customer specific products.

Product specific:

Soldering:

- The solder profile must comply with the technical product specifications. All other profiles will void the warranty.
- All other soldering methods are at the customers' own risk.

Cleaning and Washing:

- Washing agents used during the production to clean the customer application might damage or change the characteristics of the component. Washing agents may have a negative effect on the long-term functionality of the product.
- Using a brush during the cleaning process may damage the component. Therefore, we do not recommend using a brush during the PCB cleaning process.

Potting and Coating:

- Potting material might shrink or expand during and after hardening. This might apply mechanical stress on the components, which can influence the characteristics of the transfer function. In addition, potting material can close existing openings in the housing. This can lead to a malfunction of the component. Thus, potting is not recommended.

- Conformal coating may affect the product performance. We do not recommend coating the components.

Storage Conditions:

- A storage of Würth Elektronik products for longer than 12 months is not recommended. Within other effects, the terminals may suffer degradation, resulting in bad solderability. Therefore, all products shall be used within the period of 12 months based on the day of shipment.
- Do not expose the components to direct sunlight.
- The storage conditions in the original packaging are defined according to DIN EN 61760-2.
- For a moisture sensitive component, the storage condition in the original packaging is defined according to IPC/JEDEC-J-STD-033. It is also recommended to return the component to the original moisture proof bag and reseal the moisture proof bag again.
- The storage conditions stated in the original packaging apply to the storage time and not to the transportation time of the components.

Packaging:



- The packaging specifications apply only to purchase orders comprising whole packaging units. If the ordered quantity exceeds or is lower than the specified packaging unit, packaging in accordance with the packaging specifications cannot be ensured.

Handling:

- Violation of the technical product specifications such as exceeding the nominal rated supply voltage, will void the warranty.
- Violation of the technical product specifications such as but not limited to exceeding the absolute maximum ratings will void the conformance to regulatory requirements.
- ESD prevention methods need to be followed for manual handling and processing by machinery.
- The edge castellation is designed and made for prototyping, i.e. hand soldering purposes only.
- The applicable country regulations and specific environmental regulations must be observed.
- Do not disassemble the product. Evidence of tampering will void the warranty.
- The temperature rise of the component must be taken into consideration. The operating temperature is comprised of ambient temperature and temperature rise of the component. The operating temperature of the component shall not exceed the maximum temperature specified.

These cautions and warnings comply with the state of the scientific and technical knowledge and are believed to be accurate and reliable. However, no responsibility is assumed for inaccuracies or incompleteness.

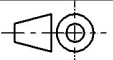
All topics are described in a more detailed manner in the user manual for each product.

	CHECKED	REVISION	DATE (YYYY-MM-DD)	GENERAL TOLERANCE	PROJECTION METHOD	
	NMe	001.001	2020-11-20	DIN ISO 2768-1m		
 WÜRTH ELEKTRONIK MORE THAN YOU EXPECT	DESCRIPTION WSEN-PADS Absolute Pressure Sensor				ORDER CODE	2511020213301
	Würth Elektronik eiSos GmbH & Co. KG EMC & Inductive Solutions Max-Eyth-Str. 1 74638 Waldenburg Germany Tel. +49 (0) 79 42 945 - 0 www.we-online.com eiSos@we-online.com				BUSINESS UNIT	
				eiSos	Valid	6/7

Important Notes

The following conditions apply to all goods within the product range of Würth Elektronik eiSos GmbH & Co. KG:

1. General Customer Responsibility

Some goods within the product range of Würth Elektronik eiSos GmbH & Co. KG contain statements regarding general suitability for certain application areas. These statements about suitability are based on our knowledge and experience of typical requirements concerning the areas, serve as general guidance and cannot be estimated as binding statements about the suitability for a customer application. The responsibility for the applicability and use in a particular customer design is always solely within the authority of the customer. Due to this fact it is up to the customer to evaluate, where appropriate to investigate and decide whether the device with the specific product characteristics described in the product specification is valid and suitable for the respective customer application or not.

2. Customer Responsibility related to Specific, in particular Safety-Relevant Applications

It has to be clearly pointed out that the possibility of a malfunction of electronic components or failure before the end of the usual lifetime cannot be completely eliminated in the current state of the art, even if the products are operated within the range of the specifications. In certain customer applications requiring a very high level of safety and especially in customer applications in which the malfunction or failure of an electronic component could endanger human life or health it must be ensured by most advanced technological aid of suitable design of the customer application that no injury or damage is caused to third parties in the event of malfunction or failure of an electronic component. Therefore, customer is cautioned to verify that data sheets are current before placing orders. The current data sheets can be downloaded at www.we-online.com.

3. Best Care and Attention

Any product-specific notes, cautions and warnings must be strictly observed. Any disregard will result in the loss of warranty.

4. Customer Support for Product Specifications

Some products within the product range may contain substances which are subject to restrictions in certain jurisdictions in order to serve specific technical requirements. Necessary information is available on request. In this case the field sales engineer or the internal sales person in charge should be contacted who will be happy to support in this matter.

5. Product R&D

Due to constant product improvement product specifications may change from time to time. As a standard reporting procedure of the Product Change Notification (PCN) according to the JEDEC-Standard inform about minor and major changes. In case of further queries regarding the PCN, the field sales engineer or the internal sales person in charge should be contacted. The basic responsibility of the customer as per Section 1 and 2 remains unaffected.

6. Product Life Cycle



Due to technical progress and economical evaluation we also reserve the right to discontinue production and delivery of products. As a standard reporting procedure of the Product Termination Notification (PTN) according to the JEDEC-Standard we will inform at an early stage about inevitable product discontinuance. According to this we cannot guarantee that all products within our product range will always be available. Therefore it needs to be verified with the field sales engineer or the internal sales person in charge about the current product availability expectancy before or when the product for application design-in disposal is considered. The approach named above does not apply in the case of individual agreements deviating from the foregoing for customer-specific products.

7. Property Rights

All the rights for contractual products produced by Würth Elektronik eiSos GmbH & Co. KG on the basis of ideas, development contracts as well as models or templates that are subject to copyright, patent or commercial protection supplied to the customer will remain with Würth Elektronik eiSos GmbH & Co. KG. Würth Elektronik eiSos GmbH & Co. KG does not warrant or represent that any license, either expressed or implied, is granted under any patent right, copyright, mask work right, or other intellectual property right relating to any combination, application, or process in which Würth Elektronik eiSos GmbH & Co. KG components or services are used.

8. General Terms and Conditions

Unless otherwise agreed in individual contracts, all orders are subject to the current version of the "General Terms and Conditions of Würth Elektronik eiSos Group", last version available at www.we-online.com.

	CHECKED	REVISION	DATE (YYYY-MM-DD)	GENERAL TOLERANCE	PROJECTION METHOD	
	NMe	001.001	2020-11-20	DIN ISO 2768-1m		
 WÜRTH ELEKTRONIK MORE THAN YOU EXPECT	DESCRIPTION WSEN-PADS Absolute Pressure Sensor				ORDER CODE	2511020213301
	Würth Elektronik eiSos GmbH & Co. KG EMC & Inductive Solutions Max-Eyth-Str. 1 74638 Waldenburg Germany Tel. +49 (0) 79 42 945 - 0 www.we-online.com eiSos@we-online.com				BUSINESS UNIT	
				eiSos	Valid	7/7