

Copying of this document and giving it to others and the use or communication of the contents thereof, are forbidden without express authority. Offenders are liable to the payment of damages. All rights are reserved in the event of the grant of a patent or the registration of the utility model or design.

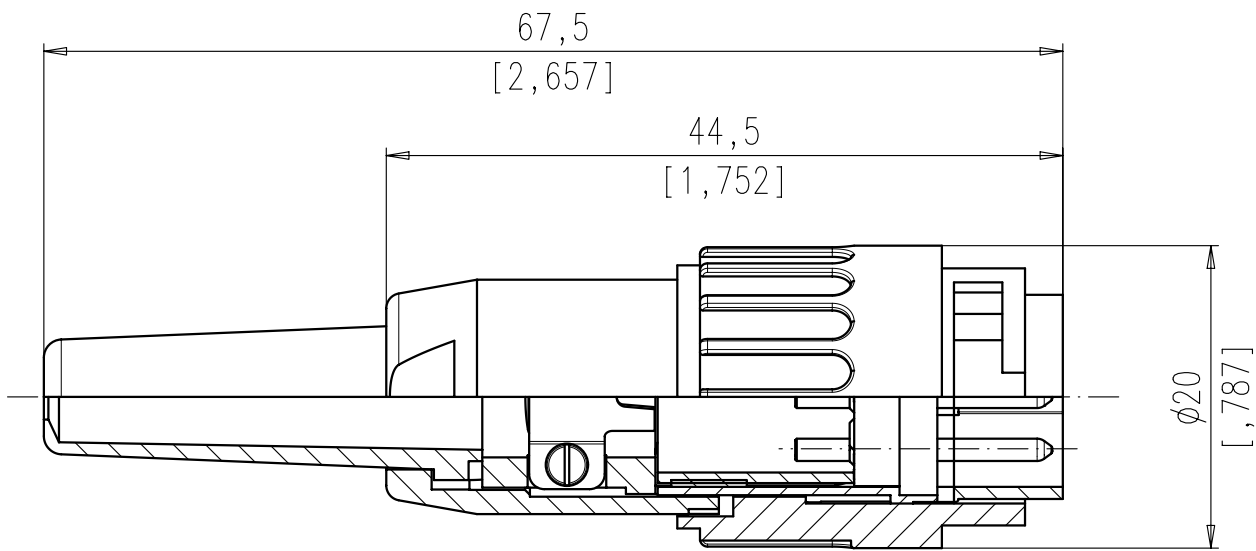

Polzahl number of contacts	Norm standard	3	4	5	5	6	7	7	8	12	14	
D Kontaktanordnung nach DIN contact arrangement acc. to DIN Kontaktanordnung nach IEC contact arrangement acc. to IEC		41524 60130-9	- 60130-9	-	41524 60130-9	45322 60130-9	-	45329 60130-9	45326 60130-9	-	-	
Bemessungsspannung rated voltage	IEC 60664-1	300V =		100V =	300V =		100V =		150V =			
Bemessungsspannung rated voltage	UL 1977	250V									60V	
Bemessungs-Stoßspannung rated impulse withstand voltage	IEC 60664-1	1500V		1200V	1500V		1200V					
Verschmutzungsgrad pollution degree	IEC 60664-1	1										
Überspannungskategorie installation category	IEC 60664-1	I										
Isolierstoffgruppe insulation group	IEC 60664-1	II, 400 ≤ CTI < 600										
Strombelastbarkeit current rating	IEC 60512-5-2 Test 5b UL 1977	5A / +40°C / +104°F							3A / +40°C / +104°F			
Isolationswiderstand insulation resistance	IEC 60512-3-1 Test 3a	>10 ¹⁰ Ω										
Durchgangswiderstand contact resistance	IEC 60512-2-1 Test 2a	< 5m Ω										
Prüfklasse climatic category	IEC 60068-1	40 / 100 / 56										
Temperaturbereich temperatur range	IEC 60068-1	-40°C ... +100°C -40°F ... +212°F										
B IP-Schutzart IP-degree	IEC 60529	IP 40										
Steck- und Ziehkraft Insertion and withdrawal forces	IEC 60512-13-2 Test 13b	25N 90.oz	30N 110.oz	35N 125.oz	50N 180.oz	55N 200.oz	60N 220.oz	50N 180.oz				
Mechanische Lebensdauer mechanical operation	IEC 60512-9-1 Test 9a	silber/silver ≥ 500 Steckzyklen/mating cycles										
Werkstoff Gehäuse housing material		Überwurfmutter Messing, Zugentlastung Zink-Druckguß, Oberfläche vernickelt coupling ring brass, strain relief, die cast, nickel plated										
Werkstoff Kontaktträger dielectric material		Thermoplast thermoplastic										
Kontaktoberfläche contact plating		silver plated										
Anschlusstechnik termination technique		löten solder										
A Anschlussquerschnitt wire gauge		löten/solder ≤ 0,5 mm ² / 20AWG							≤ 0,25 mm ² / 24 AWG			
Brennbarkeit flammability		UL 94 V0										
Verriegelung locking system		Bajonett bayonet										

	14	T 3649 501
	12	T 3629 501
	8 IEC	T 3529 501
	7 IEC	T 3449 501
	7	T 3439 501
	6	T 3429 501
	5	T 3379 501
	5 IEC	T 3399 501
	4	T 3329 501
	3	T 3279 501
SYMBOL symbol	POLZAHL number of contacts	TYP-NUMMER-AG type-number-AG

Diese Steckverbinder dürfen betriebsmäßig nicht unter Spannung betätigt werden. Metallene Gehäuseteile sind sicher mit dem Schutzleitersystem zu verbinden.
 Do not connect or disconnect under load. Metal housing parts shall be securely incorporated to protected ground.

Gewicht (errechnet)/ Calc WT:	9	Zul. Abw./Tolerances:		Maßstab/Scale	2:1	A3	
Prüfmaß/Test dimension		DIN/ISO	13715	CUSTOMER DRAWING			
Teileindex Part index number		08	Datum/Date	Name	Kabelstecker gerade Male cable connector		
		Gez.	08.07.	Cionvica			
		Drawn					
		Gep.					
		Checked					
		Amphenol-Tuchel Electronics GmbH		M	HB T 3XX9 501	Blatt/Sheet 1 1 Bl.	
01	200700144	08.07.08	CI	Ers. f./Similar to:			
Index	Änderung/Description	Datum/Date	Name				