





SPECIFICATIONS

CUSTOMER : _____
MODEL NO. : **GFT035AB320240**
VERSION : **H**
DATE : **2023.03.06**
CERTIFICATION : **ROHS**

Customer Sign	Approved By	Prepared By	Prepared By
			

晶發科技股份有限公司
GI FAR TECHNOLOGY CO.,LTD

新北市樹林區東豐街 81 號

No. 81, Dongfeng St, Shulin District, 238034, New Taipei City, Taiwan, R.O.C.

TEL: +886-2-8684-1188 FAX: +886-2-8684-8532



CONTENTS

No.	ITEM	PAGE
0	CONTENTS	3
1	SUMMARY	4
2	FEATURES	4
3	GENERAL SPECIFICATIONS	4
4	ABSOLUTE MAXIMUM RATINGS	5
5	ELECTRICAL CHARACTERISTICS	6~7
6	DC CHARATERISTICS	7
7	AC CHARACTERISTICS	8~9
8	SPI Timing Characteristics	10
9	OPTICAL CHARATERISTIC	11~13
10	INTERFACE	14~16
11	SPI Register Description	17~20
12	BLOCK DIAGRAM	21
13	QUALITY ASSURANCE	22
14	OUTLINE DRAWING	23
15	PACKAGE INFORMATION	24
16	PRECAUTIONS	25~26



1. SUMMARY

This technical specification applies to 3.5" color TFT-LCD panel. The 3.5" color TFT-LCD panel is designed for GPS, camcorder, digital camera application and other electronic products which require high quality flat panel displays. This module follows RoHS.

2. FEATURES

High Resolution: 230,400 Dots (320 RGB x 240). GFT035AB320240 is a transmissive type color active matrix liquid crystal display (LCD) which uses amorphous thin film transistor (TFT) as switching devices. This product is composed of a TFT LCD panel, driver ICs, FPC and a backlight unit. The following table described the features of TS35ND25-01.

3. GENERAL SPECIFICATIONS

Parameter	Specifications	Unit
Screen size	3.5(Diagonal)	inch
Display Format	320 RGB x 240	Dot
Active area	70.08(H) x 52.56(V)	mm
Dot size	73x 219	um
Pixel Configuration	RGB-Stripe	
Outline dimension	76.9(W) x 63.9(H) x 3.3(D)	mm
Display Mode	Normally white/Transmissive	
Display Garmut	NTSC 50%	
Input Interface	Digital 24-bit RGB	
IC	HX8218 & HX8615	
Weight	(31)	g
View Angle direction	6 o'clock	
Temperature Range	Operation	-30~85 °C
	Storage	-40~85 °C



4. ABSOLUTE MAXIMUM RATINGS

Item	Symbol	Condition	Min.	Max.	Unit	Remark
Power Voltage	DVDD,AVDD	GND=0	-0.3	7.0	V	
Input Signal Voltage	Vin	GND=0	-0.3	VDD+0.3	V	NOTE
Logic Output Voltage	VOUT	GND=0	-0.3	VDD+0.3	V	NOTE

Note: Device is subject to be damaged permanently if stresses beyond those absolute maximum ratings listed above

1. Temp. $\leq 60^{\circ}\text{C}$, 90% RH MAX.

Temp. $> 60^{\circ}\text{C}$, Absolute humidity shall be less than 90% RH at 60°C

2.

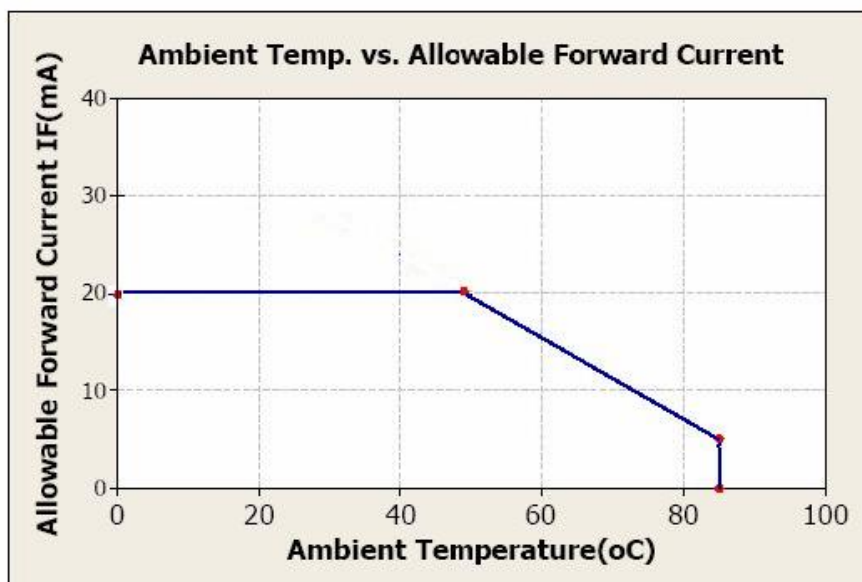



5. ELECTRICAL CHARACTERISTICS

5.1. Operating conditions:

Item	Symbol	Rating			Unit	Remark
		Min.	Typ.	Max.		
Power Voltage	VCC	3.0	3.3	3.6	V	
Digital Operation Current	Icc	-	1.02	-	mA	
Analog Power Supply	VDD	4.8	5	5.5	V	
Analog Operation Current	Idd	-	4.1	-	mA	
Gate On Power	VGH	14	15	18	V	
Gate Off Power	VGL	-11	-10	-8	V	
Vcom High Voltage	VcomH		3.5		v	
Vcom Low Voltage	VcomL		-1.6		v	
Vcom DC	VCDC		0.97		v	

Note1. VcomH& VcomL_Adjust the color with gamma data. Vp-p should be higher then 4V.(Option 5V)

Note: Please power on following the sequence VCC → VDD and V0~V13. Reverse the sequence to shut down.

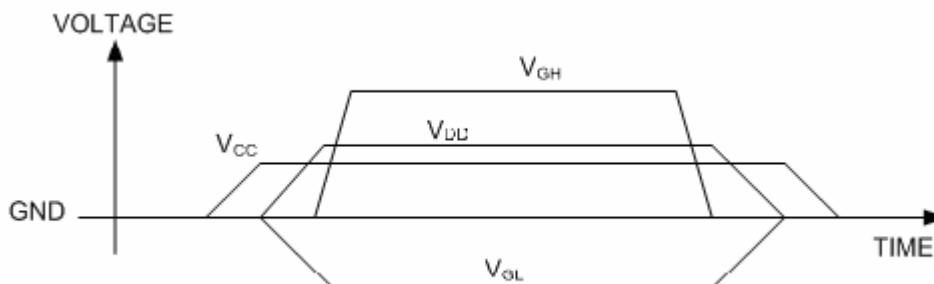

5.2 LED driving conditions

Parameter	Symbol	Min.	Typ.	Max.	Unit	Remark
LED current	-	-	20		mA	-
Power Consumption	-	-	400	420	mW	-
LED voltage	VBL+	18.6	19.8	21	V	Note 1
LED Life Time	-	-	(50,000)	-	Hr	Note 2,3

Note 1 : There are 1 Groups LED

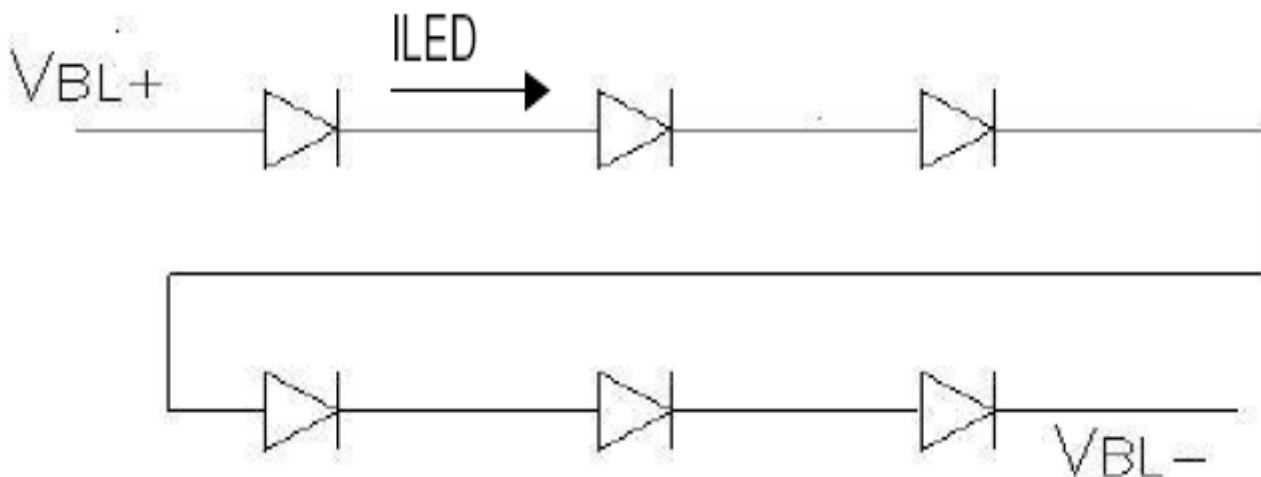

Note 2 : $T_a = 25^\circ\text{C}$

Note 3 : Brightness to be decreased to 50% of the initial value

6. DC CHARATERISTICS

Parameter	Symbol	Rating			Unit	Condition
		Min.	Typ.	Max.		
Low level input voltage	V_{IL}	0	-	$0.3V_{CC}$	V	
Hight level input voltage	V_{IH}	$0.7V_{CC}$	-	VCC	V	



7. AC CHARACTERISTICS

Signal	Item	Symbol	Min.	Typ.	Max.	Unit
Dclk	Frequency	Dclk	-	6.4	-	MHz
	High Time	Tch	-	78	-	ns
	Low Time	Tcl	-	78	-	ns
Data	Setup Time	Tds	12	-	-	ns
	Hold Time	Tdh	12	-	-	ns
Hsync	Period	TH	-	408	-	DCLK
	Pulse Width	Thp	5	30	-	DCLK
	Back-Porch	Thb	-	38	-	DCLK
	Display Period	Thd	-	320	-	DCLK
	Front-Porch	Thf	-	20	-	DCLK
Vsync	Period	TV	-	262	-	TH
	Pulse Width	Tvp	1	3	5	TH
	Back-Porch	Tvb	-	15	-	TH
	Display Period	Tvd	-	240	-	TH
	Front-Porch	Tvf	2	4	-	TH

Note: 1. $T_{hp} + T_{hb} = 68$, the user is make up by yourself.

2. $T_v = T_{vp} + T_{vb} + T_{vd} + T_{vf}$, the user is make up by yourself.

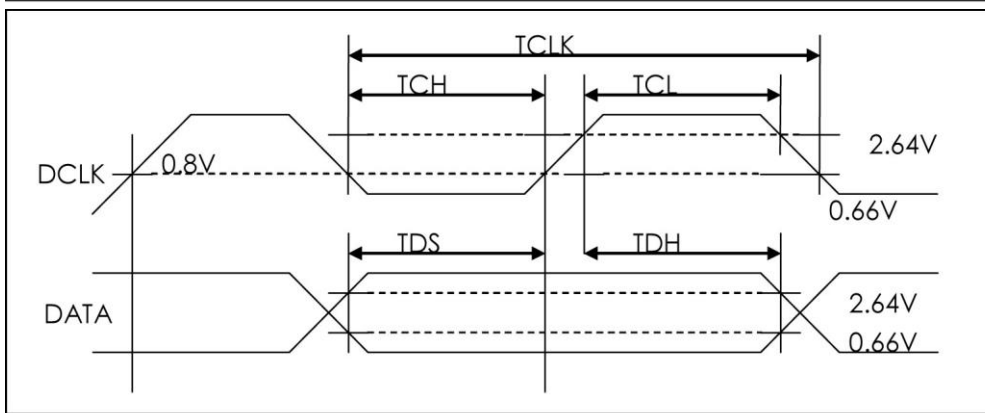
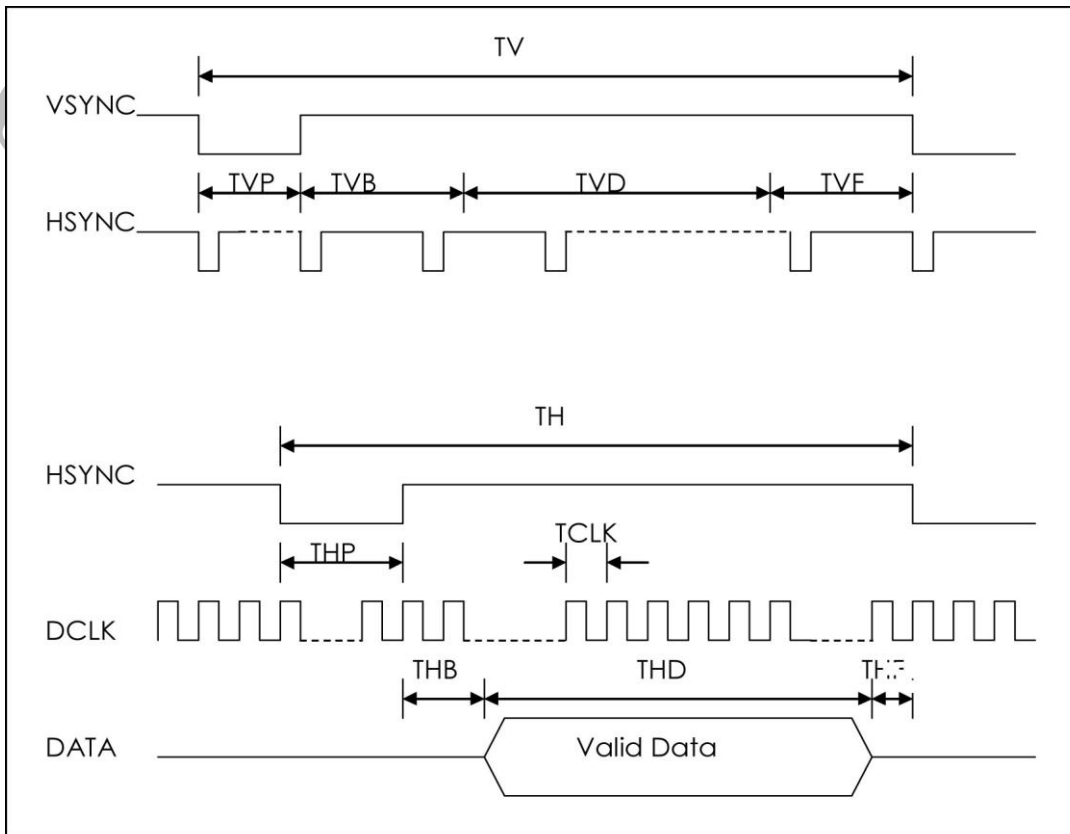

7.1 Reset Timing Chart

The RESET input must be held at least 1ms after power is stable

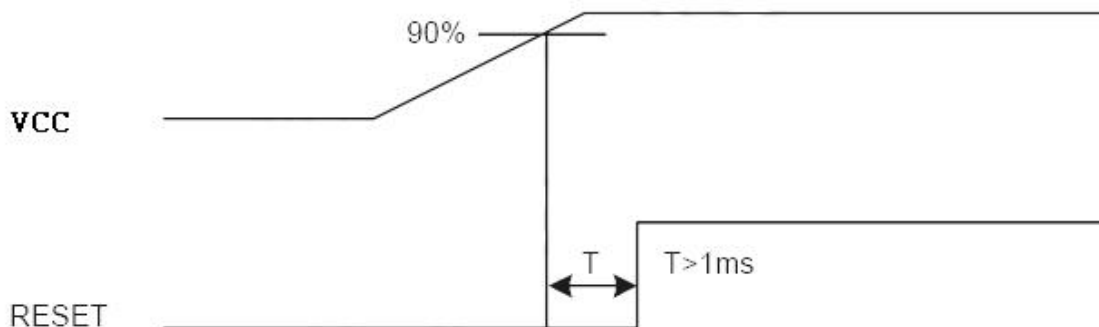

Reset timing



8. SPI Timing Characteristics

PARAMETER	Symbol	Spec.			Unit
		Min.	Typ.	Max.	
SPCK period	T_{CK}	60	-	-	ns
SPCK high width	T_{CKH}	30	-	-	ns
SPCK low width	T_{CKL}	30	-	-	ns
Data setup time	T_{SU1}	12	-	-	ns
Data hold time	T_{HD1}	12	-	-	ns
SPENA to SPCK setup time	T_{CS}	20	-	-	ns
SPENA to SPDA hold time	T_{CE}	20	-	-	ns
SPENA high pulse width	T_{CD}	50	-	-	ns
SPDA output latency	T_{CR}	-	1/2	-	T_{CK}

- SPI read timing

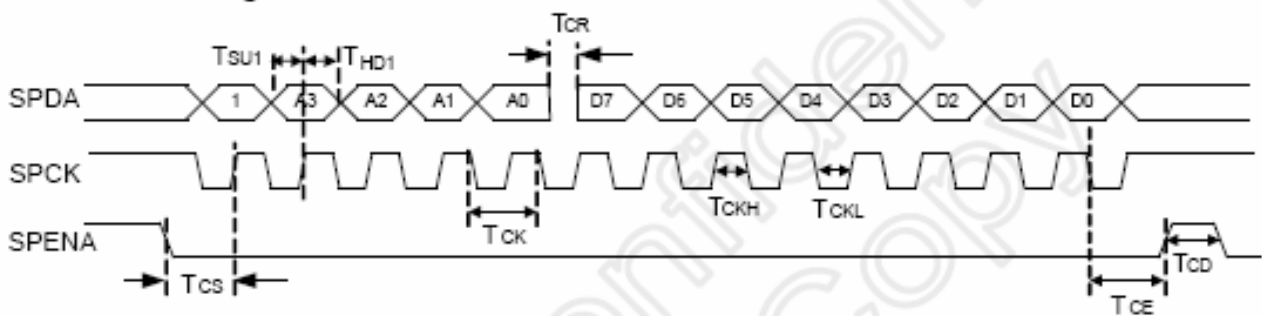

Figure 9. 1 SPI read timing

- SPI write timing

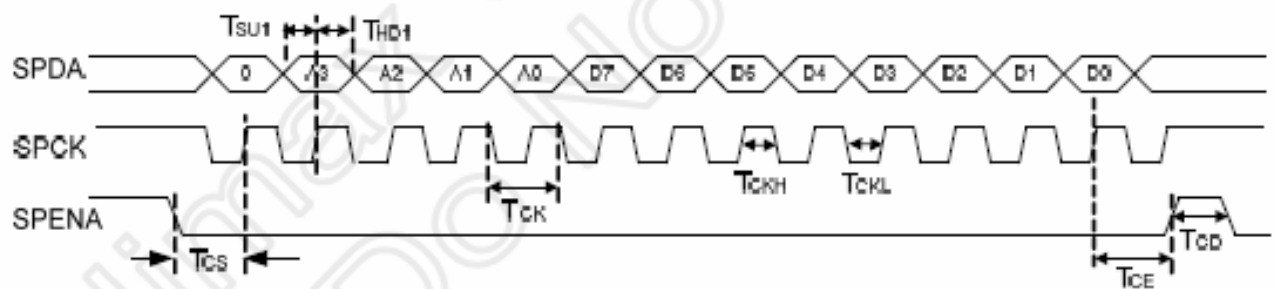

Figure 9. 2 SPI write timing



9. OPTICAL CHARACTERISTIC

$T_a=25\pm 2^{\circ}\text{C}$, $I_{LED}=20\text{mA}$

Item	Symbol	Condition	Min	Typ	Max	Unit	Remark	
Response time	TR	$\theta=0^{\circ}$ 、 $\Phi=0^{\circ}$	-	10	-	ms	Note 3,5	
	TF		-	15	-	ms		
Contrast ratio	CR	At optimized Viewing angle	200	300	-	-	Note 4,5	
Color Chromaticity	White	Wx	$\theta=0^{\circ}$ 、 $\Phi=0^{\circ}$	(0.26)	(0.31)	(0.36)	-	Note 2,6,7
		Wy		(0.28)	(0.33)	(0.38)		
Viewing Angle	Hor	Θ_R	$CR \geq 10$	(50)	(60)	-	Deg.	Note 1
		Θ_L		(50)	(60)	-		
	Ver	Ψ_H		(40)	(50)	-		
		Ψ_L		(45)	(55)	-		
Brightness	-	-	-	250	-	cd/m ²	Center of display	

$T_a=25\pm 2^{\circ}\text{C}$, $I_L=20\text{mA}$

Note 1: Definition of viewing angle range

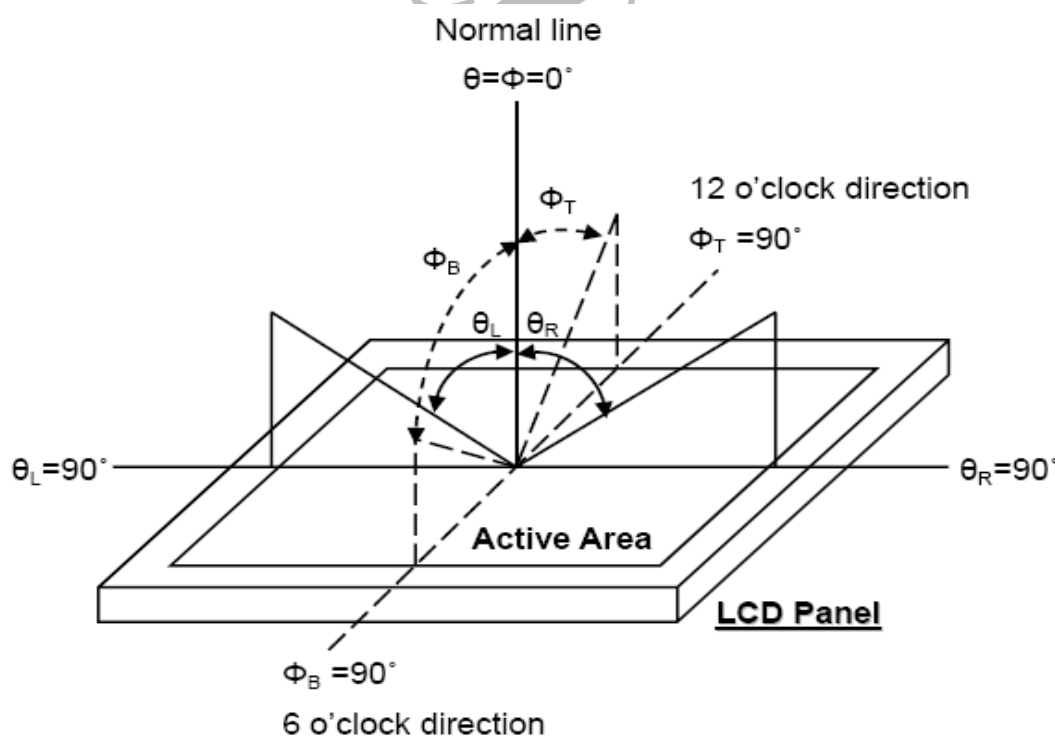

Fig. 9-1 Definition of viewing angle

Note 2: Test equipment setup:

After stabilizing and leaving the panel alone at a driven temperature for 10 minutes, the measurement should be executed. Measurement should be executed in a stable, windless, and dark room. Optical specifications are measured by Topcon BM-7 luminance meter 1.0° field of view at a distance of 50cm and normal direction.

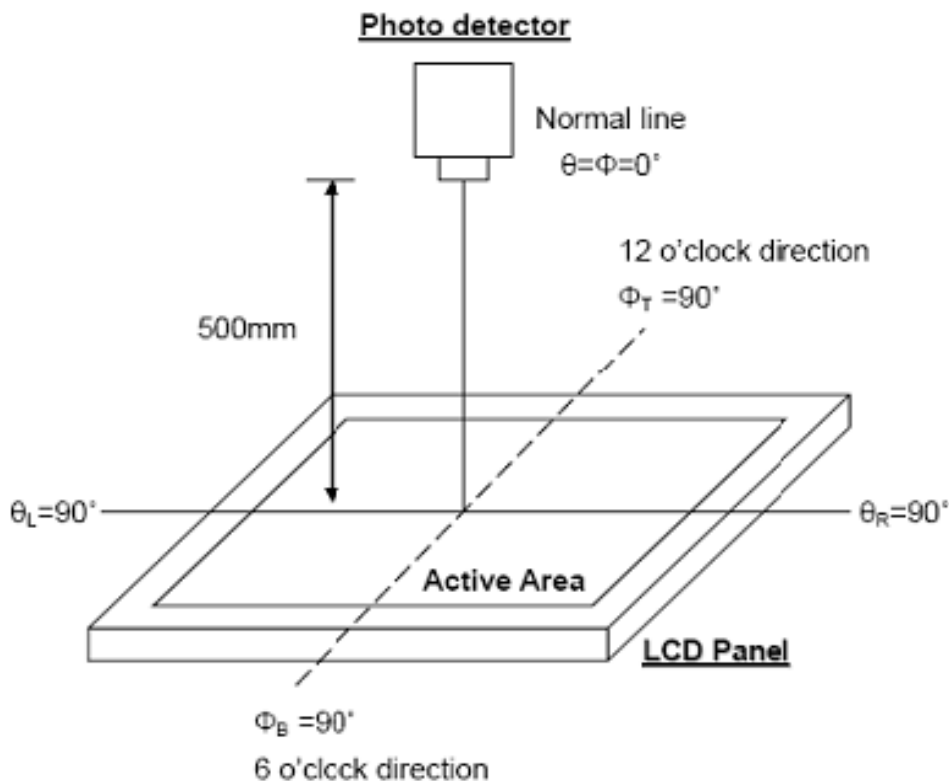

Fig. 9-2 Optical measurement system setup

Note 3: Definition of Response time:

The response time is defined as the LCD optical switching time interval between “White” state and “Black” state. Rise time, T_r , is the time between photo detector output intensity changed from 90% to 10%. And fall time, T_f , is the time between photo detector output intensity changed from 10% to 90%.

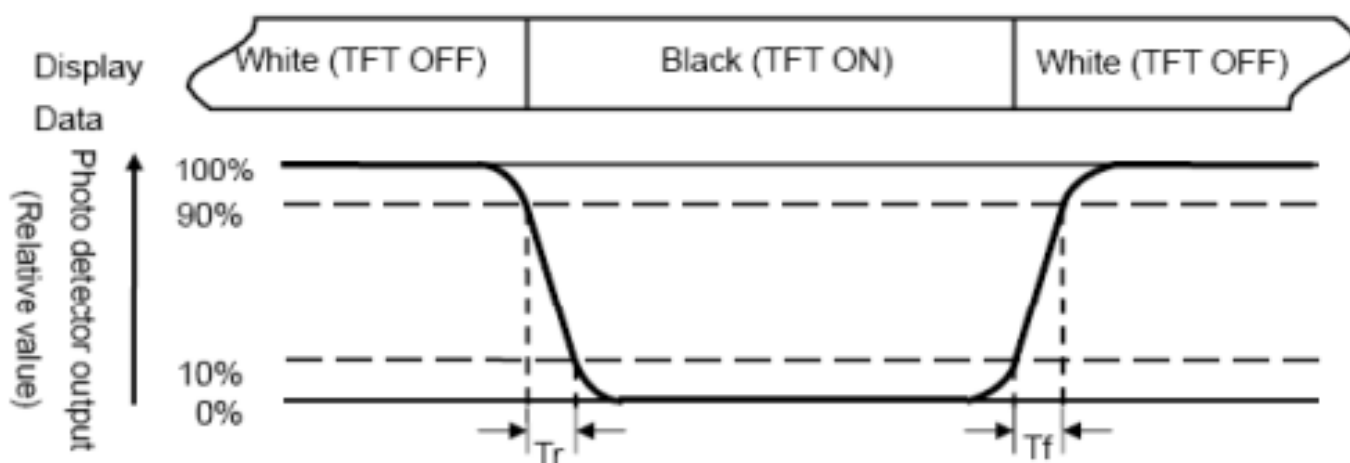

Fig. 9-3 Definition of Response time



Note 4: Definition of contrast ratio:

The contrast ratio is defined as the following expression.

$$\text{Contrast ratio (CR)} = \frac{\text{Luminance measured when LCD on the "White" state}}{\text{Luminance measured when LCD on the "Black" state}}$$

Note 5: White $V_i = V_{i50} \pm 1.5V$

Black $V_i = V_{i50} \pm 2.0V$

“±” means that the analog input signal swings in phase with VCOM signal.

“±” means that the analog input signal swings out of phase with VCOM signal.

The 100% transmission is defined as the transmission of LCD panel when all the input terminals of module are electrically opened.

Note 6: Definition of color chromaticity (CIE 1931)

Color coordinates measured at the center point of LCD

Note 7: Measured at the center area of the panel when all the input terminals of LCD panel are electrically opened.

$$\text{Note 8 : Uniformity (U)} = \frac{\text{Brightness (min)}}{\text{Brightness (max)}} \times 100\%$$



10. INTERFACE

10.1. LCM PIN Definition

Pin	Symbol	I/O	I/O Function	Remark
1	LED-	I	Backlight LED Ground	
2	LED-	I	Backlight LED Ground	
3	LED+	I	Backlight LED Power	
4	LED+	I	Backlight LED Power	
5	NC	I	NC	
6	NC	I	NC	
7	POL	O	Polarity Signal Connect to Vcom driving circuit	Note 1, 4
8	/RESET	I	Hardware Reset	
9	SPENA	I	SPI Interface Data Enable signal	
10	SPCLK	I	SPI Interface Data Clock	
11	SPDAT	I	SPI Interface Data	
12	B0	I	Blue Data Bit 0	
13	B1	I	Blue Data Bit 1	
14	B2	I	Blue Data Bit 2	
15	B3	I	Blue Data Bit 3	
16	B4	I	Blue Data Bit 4	
17	B5	I	Blue Data Bit 5	
18	B6	I	Blue Data Bit 6	
19	B7	I	Blue Data Bit 7	
20	G0	I	Green Data Bit0	
21	G1	I	Green Data Bit1	
22	G2	I	Green Data Bit2	
23	G3	I	Green Data Bit3	
24	G4	I	Green Data Bit4	
25	G5	I	Green Data Bit5	
26	G6	I	Green Data Bit6	
27	G7	I	Green Data Bit7	
28	R0	I	IRed Data Bit0	
29	R1	I	Red Data Bit1	
30	R2	I	Red Data Bit2	
31	R3	I	Red Data Bit3	
32	R4	I	Red Data Bit4	
33	R5	I	Red Data Bit5	
34	R6	I	Red Data Bit6	
35	R7	I	Red Data Bit7	



GFT035AB320240

36	HSYNC	I	Horizontal Sync Input	
37	VSYNC	I	Vertical Sync Input	
38	DCLK	I	Dot Data Clock	
39	VDD	I	Analog Power	
40	VDD	I	Analog Power	
41	VCC	I	Digital Power	
42	VCC	I	Digital Power	
43	NC	I	NC	Note 3
44	NC	I	NC	
45	VGL	I	Gate OFF Power	
46	NC	-	Not Use	
47	VGH	I	Gate ON Power	
48	NC	-	Not Use	
49	NC	-	Not Use	Note 3
50	NC	-	Not Use	
51	VCOM	I	Driving Input	Note 1, 4
52	DEN	I	Data Enable Input	Note 2
53	AVSS	I	Ground	
54	DGND	I	Ground	

Note:

1. The polarity of Vcom (Pin 51) should be generated from POL (Pin 7).
2. For digital RGB input data format, both SYNC mode and DE+SYNC mode are supported. If ENB signal is fixed low, SYNC mode is used. Otherwise, DE+SYNC mode is used.
3. Pin 9 · Pin 10 usually pull high.
4. The phase of POL (pin 7):

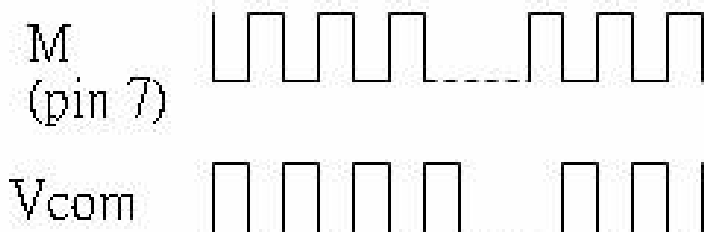



GFT035AB320240

10.2 Basic Display Color and Gray Scale

Color		Input Color Data																							
		Red								Green								Blue							
		MSB				LSB				MSB				LSB				MSB				LSB			
		R7	R6	R5	R4	R3	R2	R1	R0	G7	G6	G5	G4	G3	G2	G1	G0	B7	B6	B5	B4	B3	B2	B1	B0
Basic Colors	Black	0	0	0	0	0	0	0	0	0	0	0	0	0	0	0	0	0	0	0	0	0	0	0	0
	Red(255)	1	1	1	1	1	1	1	1	0	0	0	0	0	0	0	0	0	0	0	0	0	0	0	0
	Green(255)	0	0	0	0	0	0	0	0	1	1	1	1	1	1	1	1	0	0	0	0	0	0	0	0
	Blue(255)	0	0	0	0	0	0	0	0	0	0	0	0	0	0	0	0	1	1	1	1	1	1	1	1
	Cyan	0	0	0	0	0	0	0	0	1	1	1	1	1	1	1	1	1	1	1	1	1	1	1	1
	Magenta	1	1	1	1	1	1	1	1	0	0	0	0	0	0	0	0	1	1	1	1	1	1	1	1
	Yellow	1	1	1	1	1	1	1	1	1	1	1	1	1	1	1	1	0	0	0	0	0	0	0	0
	White	1	1	1	1	1	1	1	1	1	1	1	1	1	1	1	1	1	1	1	1	1	1	1	1
Red	Red(0) Dark	0	0	0	0	0	0	0	0	0	0	0	0	0	0	0	0	0	0	0	0	0	0	0	0
	Red(1)	0	0	0	0	0	0	0	1	0	0	0	0	0	0	0	0	0	0	0	0	0	0	0	0
	Red(2)	0	0	0	0	0	0	1	0	0	0	0	0	0	0	0	0	0	0	0	0	0	0	0	0
	:	:	:	:	:	:	:	:	:	:	:	:	:	:	:	:	:	:	:	:	:	:	:	:	:
	Red(253)	1	1	1	1	1	1	0	1	0	0	0	0	0	0	0	0	0	0	0	0	0	0	0	0
	Red(254)	1	1	1	1	1	1	1	0	0	0	0	0	0	0	0	0	0	0	0	0	0	0	0	0
	Red(255) Bright	1	1	1	1	1	1	1	1	0	0	0	0	0	0	0	0	0	0	0	0	0	0	0	0
Green	Green(0) Dark	0	0	0	0	0	0	0	0	0	0	0	0	0	0	0	0	0	0	0	0	0	0	0	0
	Green(1)	0	0	0	0	0	0	0	0	0	0	0	0	0	0	1	0	0	0	0	0	0	0	0	
	Green(2)	0	0	0	0	0	0	0	0	0	0	0	0	0	1	0	0	0	0	0	0	0	0	0	
	:	:	:	:	:	:	:	:	:	:	:	:	:	:	:	:	:	:	:	:	:	:	:	:	
	Green(253)	0	0	0	0	0	0	0	0	1	1	1	1	1	1	0	1	0	0	0	0	0	0	0	
	Green(254)	0	0	0	0	0	0	0	0	1	1	1	1	1	1	1	0	0	0	0	0	0	0	0	
	Green(255)Bright	0	0	0	0	0	0	0	0	1	1	1	1	1	1	1	1	0	0	0	0	0	0	0	
Blue	Blue(0) Dark	0	0	0	0	0	0	0	0	0	0	0	0	0	0	0	0	0	0	0	0	0	0	0	0
	Blue(1)	0	0	0	0	0	0	0	0	0	0	0	0	0	0	0	0	0	0	0	0	0	0	0	1
	Blue(2)	0	0	0	0	0	0	0	0	0	0	0	0	0	0	0	0	0	0	0	0	0	0	1	0
	:	:	:	:	:	:	:	:	:	:	:	:	:	:	:	:	:	:	:	:	:	:	:	:	
	Blue(253)	0	0	0	0	0	0	0	0	0	0	0	0	0	0	0	0	1	1	1	1	1	1	0	1
	Blue(254)	0	0	0	0	0	0	0	0	0	0	0	0	0	0	0	0	1	1	1	1	1	1	1	0
	Blue(255) Bright	0	0	0	0	0	0	0	0	0	0	0	0	0	0	0	0	1	1	1	1	1	1	1	1



11. SPI Register Description

- Register R0

Bit	D7	D6	D5	D4	D3	D2	D1	D0
Name	reserved	STHD1	STHD0	STHP4	STHP3	STHP2	STHP1	STHP0
Default	0	0	0	0	0	0	0	0

Table 11.1 Register R0 setting

STHD [1:0]: adjust start pulse position by dot. (RGB mode only)

STHD1	STHD0	STH position adjust by dot
1	1	-1
1	0	-2
0	0	0
0	1	+1

Table 11.2 Adjust start pulse position by dot

STHP [4:0]: adjust start pulse position by pixel

STHP4	STHP3	STHP2	STHP1	STHP0	STH position adjust by pixel
1	1	1	1	1	-1
1	1	1	1	0	-2
1	1	1	0	1	-3
1	1	1	0	0	-4
1	1	0	1	1	-5
1	1	0	1	0	-6
1	1	0	0	1	-7
1	1	0	0	0	-8
1	0	1	1	1	-9
1	0	1	1	0	-10
1	0	1	0	1	-11
1	0	1	0	0	-12
1	0	0	1	1	-13
1	0	0	1	0	-14
1	0	0	0	1	-15
1	0	0	0	0	-16
0	0	0	0	0	0
0	0	0	0	1	+1
0	0	0	1	0	+2
0	0	0	1	1	+3
0	0	1	0	0	+4
0	0	1	0	1	+5
0	0	1	1	0	+6
0	0	1	1	1	+7
0	1	0	0	0	+8
0	1	0	0	1	+9
0	1	0	1	0	+10
0	1	0	1	1	+11
0	1	1	0	0	+12
0	1	1	0	1	+13
0	1	1	1	0	+14
0	1	1	1	1	+15

Table 11.3 Adjust start pulse position by pixel



● Register R1

Bit	D7	D6	D5	D4	D3	D2	D1	D0
Name	STVP3	STVP2	STVP1	STVP0	STVNT1	STVNT0	STVPAL1	STVPAL0
Default	0	0	0	0	0	0	0	0

Table 11.4 Register R1 setting

STVP [3:0]: adjust first line position by line

STVP3	STVP2	STVP1	STVP0	STV position adjust by line
1	1	1	1	-1
1	1	1	0	-2
1	1	0	1	-3
1	1	0	0	-4
1	0	1	1	-5
1	0	1	0	-6
1	0	0	1	-7
1	0	0	0	-8
0	0	0	0	0
0	0	0	1	+1
0	0	1	0	+2
0	0	1	1	+3
0	1	0	0	+4
0	1	0	1	+5
0	1	1	0	+6
0	1	1	1	+7

Table 11.5 Adjust first line position by line

STVNT[1:0]: Adjust the relationship of first line of active video in Odd/Even Field in NTSC mode.

00: The first line of active video in Even Field = The first line of active video in Odd Field

01: The first line of active video in Even Field = The first line of active video in Odd Field + 1

10: No Use

11: The first line of active video in Even Field = The first line of active video in Odd Field - 1

STVPAL[1:0]: Adjust the relationship of first line of active video in Odd/Even Field in PAL mode.

00: The first line of active video in Even Field = The first line of active video in Odd Field

01: The first line of active video in Even Field = The first line of active video in Odd Field + 1



● Register R2

Bit	D7	D6	D5	D4	D3	D2	D1	D0
Name	LPF	RGBVPOL	OEHCTL	OVER	VS_POL	HS_POL	NPC_IN	NPC_SET
Default	1	0	1	0	1	0	1	0

Table 11.6 Register R2 setting

LPF: Low pass filter function enable/disable in CCIR656/CCIR601 mode

LPF="L", Low pass filter function disable

LPF="H", Low pass filter function enable

RGBVPOL: RGB mode VS polarity setting

RGBVPOL ="L", negative polarity.

RGBVPOL ="H", positive polarity

OEHCTL: OEH signal control in PAL mode

OVER: Sets display period in ITU-R BT. 656 or 601 modes.

0 => 50.3us of active data is displayed on the panel.

1 => 53.3 us of active data is displayed on the panel.

VS_POL: CCIR601 VS polarity setting.

VS_POL=L, negative polarity.

VS_POL=H, positive polarity.

HS_POL: HS polarity setting.

HS_POL=L, negative polarity.

HS_POL=H, positive polarity.

NPC_IN: Define the NTSC/PAL mode by SPI.

NPC_IN=L, PAL.

NPC_IN=H, NTSC.

NPC_SET: Set the NTSC/PAL auto detection or define by NPC_IN.

NPC_SET=L, auto detection.

NPC_SET=H, define by NPC_IN.



● Register R3

Bit	D7	D6	D5	D4	D3	D2	D1	D0
Name	AUTO_DP	DISP_ON	A_TIME1	A_TIME0	reserved	POL_OUT	DE_POL	DE_SEL
Default	1	0	0	1	0	0	0	0

Table 11.6 Register R3 setting

AUTO_DP: When power on, select black image display time decided by A_TIME (bit5, 4) or DISP_ON (bit6).

AUTO_DP = "L", Black image display time decided by DISP_ON (bit6).

AUTO_DP = "H", Black image display time decided by A_TIME(bit5, 4).

DISP_ON: When AUTO_DP (bit7) = "L", and DISP_ON = "H", black image display off, then display normal image.

A_TIME: When AUTO_DP(bit7) = "H", the black image display time is decided by A_TIME

00: black image display time is 0.166s (10 fields)

01: black image display time is 0.332s (20 fields)

10: black image display time is 0.664s (40 fields)

11: black image display time is 1.328s (80 fields)

POL_OUT: POL phase select

POL_OUT=L, POL and VCOM are in phase.

POL_OUT=H, POL and VCOM are reverse.

DE_POL: DE signal polarity setting.

When DE_SEL=L:

DE_POL =L, positive polarity.

DE_POL =H, negative polarity.

When DE_SEL=H:

DE_POL =L, negative polarity.

DE_POL =H, positive polarity.

DE_SEL: DE mode select.

DE_SEL=L, DE signal with HS and VS signal

DE_SEL=H, DE signal only

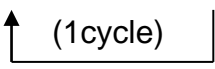

13.QUALITY ASSURANCE

NO.	ITEM	CONDITION		STANDARD	NOTE
1	High Temp. Storage	85°C	120 hrs	Appearance Without defect	
2	Low Temp. Storage	-40°C	120 hrs	Appearance Without defect	
3	High Temp. & High Humi. Storage	40°C 90% RH	120 hrs	Appearance Without defect	
4	High Temp. Operating Display	85°C	120 hrs	Appearance Without defect	
5	Low Temp. Operating Display	-30°C	120 hrs	Appearance Without defect	
6	Thermal Shock	-30°C, 30min. → 85°C,30min. 		Appearance Without defect	10 cycles

** Dissipation current, contrast and display functions

** Polarizing filter deterioration, other appearance defects

** The function test shall be conducted after 4hours storage at the normal temperature and humidity after remove from the test chamber.



15.PACKAGE INFORMATION

1	1 Tray	:	8 pcs (modules)
2	1 stack	:	8 tray +1 Cover tray
3	1 Carton	:	(1 Cover tray + 8 tray)x 2 stack
4	Total pcs	:	1 Carton (8pcs * 8tray * 4 stack) = 256 pcs
5	Carton size = NO. 17	:	495*315*435mm
7	Net weight	:	7.7 KG
8	Gross weight	:	13.8 KG

** 包裝示意圖片

- 一個 tray 盤 可放 8PCS 模組

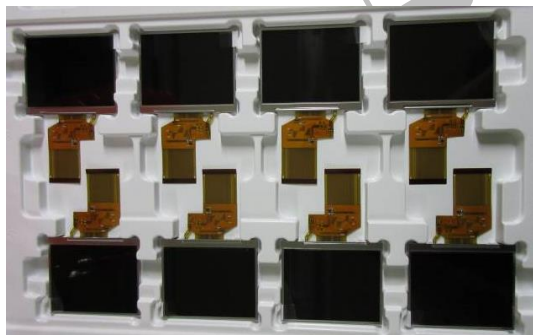

- 8 盤+1 空盤=1 疊，一箱可放入 4 疊，TRAY 盤上、下兩層需交錯堆疊放置



- 使用 17 號箱，可放入 4 疊，並使用防震材將旁邊空隙填滿





16. PRECAUTIONS

Please pay attention to the following when you use this TFT LCD module.

16.1 MOUNTING PRECAUTIONS

- (1) You must mount a module using arranged in four corners or four sides.
- (2) You should consider the mounting structure so that uneven force (ex. Twisted stress) is not applied to the module. And the case on which a module is mounted should have sufficient strength so that external force is not transmitted directly to the module.
- (3) Please attach a transparent protective plate to the surface in order to protect the polarizer. Transparent protective plate should have sufficient strength in order to the resist external force.
- (4) You should adopt radiation structure to satisfy the temperature specification.
- (5) Acetic acid type and chlorine type materials for the cover case are not describe because the former generates corrosive gas of attacking the polarizer at high temperature and the latter causes circuit break by electro-chemical reaction.
- (6) Do not touch, push or rub the exposed polarizers with glass, tweezers or anything harder than HB pencil lead. And please do not rub with dust clothes with chemical treatment. Do not touch the surface of polarizer for bare hand or greasy cloth. (Some cosmetics are determined to the polarizer)
- (7) When the surface becomes dusty, please wipe gently with adsorbent cotton or other soft materials like chamois soaks with petroleum benzene. Normal-hexane is recommended for cleaning the adhesives used to attach front / rear polarizers. Do not use acetone, toluene and alcohol because they cause chemical damage to the polarizer.
- (8) Wipe off saliva or water drops as soon as possible. Their long time contact with polarizer causes deformations and color fading.
- (9) Do not open the case because inside circuits do not have sufficient strength.

16.2 OPERATING PRECAUTIONS

- (1) The spike noise causes the mis-operation of circuits. It should be lower than following voltage_ $V = \pm 200\text{mV}$ (Over and under shoot voltage)
- (2) Response time depends on the temperature. (In lower temperature, it becomes longer.)
- (3) Brightness depends on the temperature. (In lower temperature, it becomes lower) And in lower temperature, response time (required time that brightness is stable after turned on) becomes longer.
- (4) Be careful for condensation at sudden temperature change. Condensation makes damage to polarizer or electrical contacted parts. And after fading condensation, smear or spot will occur.
- (5) When fixed patterns are displayed for a long time, remnant image is likely to occur.
- (6) Module has high frequency circuits. Sufficient suppression to the electromagnetic interference shall be done by system manufacturers. Grounding and shielding methods may be important to minimize the interference.



16.3 ELECTROSTATIC DISCHARGE CONTROL

Since a module is composed of electronic circuits, it is not strong to electrostatic discharge.

Make certain that treatment persons are connected to ground through wristband etc. And don't touch interface pin directly.

16.4 PRECAUTIONS FOR STRONG LIGHT EXPOSURE

Strong light exposure causes degradation of polarizer and color filter.

16.5 STORAGE

When storing modules as spares for a long time, the following precautions are necessary.

- (1) Store them in a dark place. Do not expose the module to sunlight or fluorescent light. Keep the temperature between 5°C and 35°C at normal humidity.
- (2) The polarizer surface should not come in contact with any other object. It is recommended that they be stored in the container in which they were shipped.

16.6 HANDLING PRECAUTIONS FOR PROTECTION FILM

- (1) When the protection film is peeled off, static electricity is generated between the film and polarizer. This should be peeled off slowly and carefully by people who are electrically grounded and with well ion-blown equipment or in such a condition, etc.
- (2) The protection film is attached to the polarizer with a small amount of glue. Is apt to remain on the polarizer. Please carefully peel off the protection film without rubbing it against the polarizer.
- (3) When the module with protection film attached is stored for a long time, sometimes there remains a very small amount of glue still on the polarizer after the protection film is peeled off.
- (4) You can remove the glue easily. When the glue remains on the polarizer surface or its vestige is recognized, please wipe them off with absorbent cotton waste or other soft material like chamois soaked with normal-hexane.

16.7 OPERATION PRECAUTIONS

Any changes that need to be made in this specification or any problems arising from it will be dealt with quickly by discussion between both companies.

Quality warranty period: Within one year after shipment date (excluding abnormal usage way and abnormal environments.)

出貨檢驗標準書
Shipping inspection standard

核准 Approved by	審核 Checked by	作成 Made by
ANDY	JACKY	RUBY

1.目的 Purpose :

規範出貨產品之檢驗項目及判斷標準，確保產品出貨能滿足客戶要求。

Standardize the inspection items and judgment standards to ensure the products that shipped out can meet customer's requirements.

2.範圍 Area :

適用於出廠之所有產品。

Applicable to all products shipped from the factory.

3.名詞解釋 Explanation of terms :

3-1 主要缺陷：亦會造成功能缺失或嚴重外觀缺陷。

Major Defects: It also causes loss of function or serious appearance defects.

3-2 次要缺陷：稍有缺陷但不影響客戶使用。

Minor defect: Slightly defective but does not affect customer use.

4.檢驗體制 Inspection system :

4-1 抽樣計劃：依 ANSI/ASQ Z1.4 一般檢驗水準 II 之 正常檢驗一次抽驗方案。

Sampling plan: According to ANSI/ASQ Z1.4 general inspection level II the normal inspection one-time sampling plan.

4-2 允收水準 Acceptable Level : (AQL)

主要缺陷 Major defect : 0.4 %

次要缺陷 Minor defect : 0.65 %

5.檢驗條件 Inspection conditions :

5-1 使用相關之檢測儀器及測試、量測工具。

Use relevant testing instrument, testing and measuring tools .

5-2 環境要求：其條件需控制在常溫下 $23^{\circ}\text{C}\pm 3^{\circ}\text{C}$ 及溼度 70%RH 以下。

Environmental requirements: The conditions should be controlled at room temperature $23^{\circ}\text{C}\pm 3^{\circ}\text{C}$ and humidity below 70%RH.

5-3 外觀檢驗：須在 $380\pm 20\%$ LUX 的白色日光燈下，其目視距離需於產品離 30 ± 5 cm 檢驗。

Appearance inspection: Under the white fluorescent lamp of $380\pm 20\%$ LUX , the visual distance shall be checked above the product 30 ± 5 cm.

5-4 電性測試 Electrical Testing :

5-4-1 有背光之產品需關燈並在 $5\sim 300\text{Lux}\pm 3\%$ 下檢驗。

The products with backlight should be tested at $5\sim 300\pm 3\%$ Lux.

5-4-2 無背光之產品需開燈並在 $60\sim 300\text{Lux}\pm 3\%$ 白色日光燈下檢驗。

Products without backlight need to be turned on and tested under $60\sim 300 \pm 3\%$ LUX white fluorescent lamps .

5-5 檢查視角依產品視角方向。

Check the viewing angle according to the product viewing angle.

5-6 其不良現象檢視區域 Bad phenomenon View area

5-6-1 適用種類 Applicable category : COB、TFT

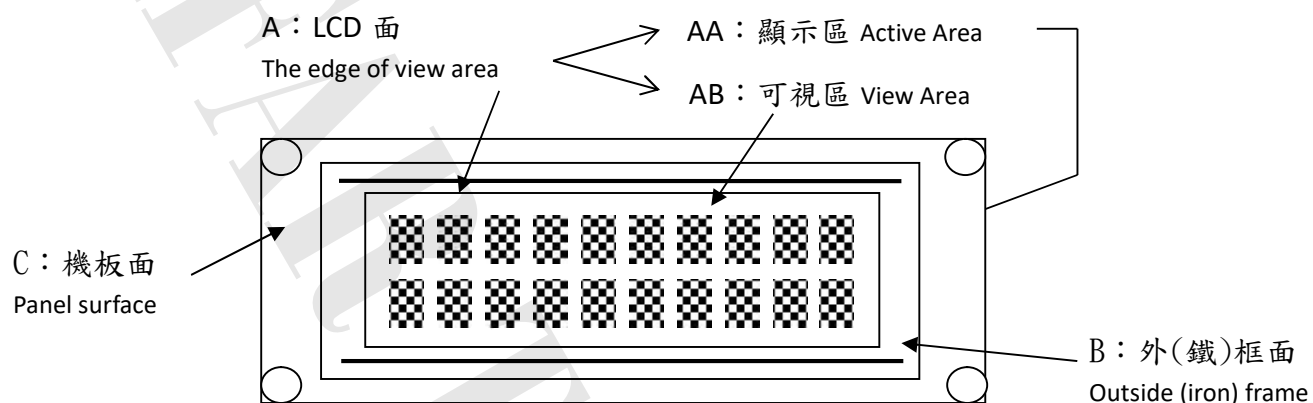

5-6-2 適用種類 Applicable category : COG、TAB、TN

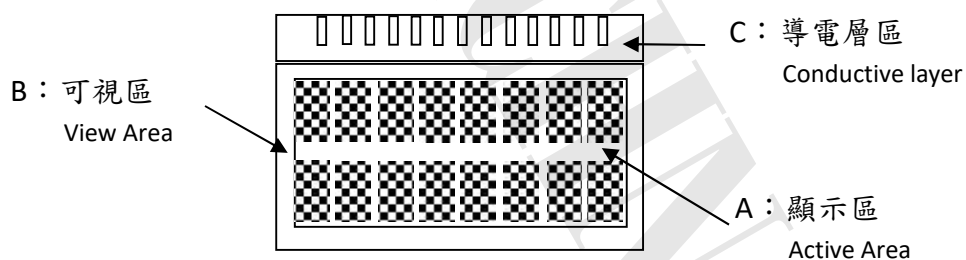

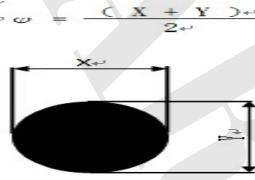
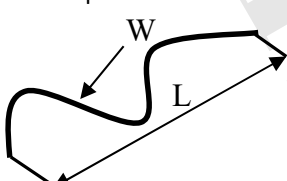
種類 Category		TFT																
編號 No.	檢驗項目 Item	檢驗內容及判定標準 Inspection Content & Standard	區域 Zone	類別 Category	缺陷等級 Level													
1	點類(一) Dot (1)	氣泡...圓狀 Bubble ...round shape 	兩點距離須超過 5 mm Two points have to be ≥ 5 mm <table border="1"> <tr> <th>ϕ (mm)</th> <th>允收數 Acceptance Qty</th> </tr> <tr> <td>$\phi \leq 0.25$</td> <td>無視 Ignore</td> </tr> <tr> <td>$0.25 < \phi \leq 0.5$</td> <td>3</td> </tr> <tr> <td>$\phi > 0.5$</td> <td>0</td> </tr> </table>	ϕ (mm)	允收數 Acceptance Qty	$\phi \leq 0.25$	無視 Ignore	$0.25 < \phi \leq 0.5$	3	$\phi > 0.5$	0	A	外觀 Appearance	次要 Minor AQL0.65%				
ϕ (mm)	允收數 Acceptance Qty																	
$\phi \leq 0.25$	無視 Ignore																	
$0.25 < \phi \leq 0.5$	3																	
$\phi > 0.5$	0																	
2	線類 Line	刮傷、毛屑...等線狀 Scratch、Fiber.. and other linear shape. 	<table border="1"> <tr> <th>L (mm)</th> <th>W (mm)</th> <th>允收數 Acceptance Qty</th> </tr> <tr> <td>--</td> <td>$W \leq 0.01$</td> <td>無視 Ignore</td> </tr> <tr> <td>$L \leq 3$</td> <td>$0.01 < W \leq 0.05$</td> <td>3</td> </tr> <tr> <td>$L > 3$</td> <td>$W > 0.05$</td> <td>0</td> </tr> </table>	L (mm)	W (mm)	允收數 Acceptance Qty	--	$W \leq 0.01$	無視 Ignore	$L \leq 3$	$0.01 < W \leq 0.05$	3	$L > 3$	$W > 0.05$	0	A	外觀 Appearance	次要 Minor AQL0.65%
L (mm)	W (mm)	允收數 Acceptance Qty																
--	$W \leq 0.01$	無視 Ignore																
$L \leq 3$	$0.01 < W \leq 0.05$	3																
$L > 3$	$W > 0.05$	0																
3	FPC 外觀 FPC Appearance	※ FPC 上刺傷導致線路無法導通 拒收 Stabbing on the FPC causes the line to fail to conduct Reject ※ FPC 上髒污或是殘留異物以致線路無法導通 拒收 Dirty or residual foreign matter on the FPC makes the circuit unable to conduct Reject ※ FPC 直角折痕、斷裂 拒收 FPC right-angle crease and fracture Reject	C	外觀 Appearance	次要 Minor AQL0.65%													
4	點類(二) Dot (2)	<table border="1"> <tr> <th>類型 Type</th> <th>允收數 Acceptance Qty</th> </tr> <tr> <td>亮點 Highlights</td> <td>$N \leq 2$</td> </tr> <tr> <td>暗點 dark spot</td> <td>$N \leq 3$</td> </tr> </table> ※ 缺陷點面積暫全點 1/2 則為一個缺陷點 Temporarily full area of defect point 1/2 is a defect point ※ 亮點：於黑畫面中使用 2% ND Filter 遮蓋須不可見 Highlights: Use 2% ND Filter in a black screen to cover up invisible ※ 暗點：在純紅、綠、藍模式下判定 Dark spot: judged in pure red, green and blue mode	類型 Type	允收數 Acceptance Qty	亮點 Highlights	$N \leq 2$	暗點 dark spot	$N \leq 3$	AA	電訊 Electronics	次要 Minor AQL0.65%							
類型 Type	允收數 Acceptance Qty																	
亮點 Highlights	$N \leq 2$																	
暗點 dark spot	$N \leq 3$																	

5	無動作 No reaction	顯示畫面一直處於起始畫面而無法進行切換 拒收 The display (view area) always shows in the initial screen and can't be switched to others. Reject	AA	電訊 Electronics	主要 Major AQL 0.4%
6	無畫面 No display	通電後，完全無任何畫面顯示 拒收 After connecting to the power, there is no display. Reject	AA	電訊 Electronics	主要 Major AQL 0.4%
7	斷線 Broken line	顯示畫面中少直、橫線 拒收 There is a lack of vertical or horizontal lines in the view area. Reject	AA	電訊 Electronics	主要 Major AQL 0.4%
8	I CON	顯示畫面缺少部份顯示圖案 拒收 Lack of partial ICON in the view area. Reject	AA	電訊 Electronics	主要 Major AQL 0.4%
9	深淺不一 Color difference	顯示畫面的對比，比其他顯示深或淺並依電氣規格(VOP)值判定 The contrast of display is obviously lighter or darker than others and according to the VOP value in the electronics specification. 拒收或與客端簽訂限度樣 Reject or inspect according to the golden sample	AA	電訊 Electronics	次要 Minor AQL0.65%
10	畫面異常 Abnormal screen	通電後畫面出現未定義之電訊不良現象 拒收 After connecting to the power, there is a undefined electronics appearance showing in the view area. Reject	AA	電訊 Electronics	主要 Major AQL 0.4%
11	牛頓環 Newton ring	點亮後目視有環、圓或曲線狀 拒收 There are rings, circles or curves visually after lighting Reject	A	電訊 Electronics	次要 Minor AQL0.65%
12	背光色不均 Uneven color of backlight	※ 點亮後 LED 有明暗不均現象依其均勻度判定 拒收 After lighting LEDs have brightness and darkness uneven the determined according to its uniformity. Reject ※ 點亮後 LED 色澤不一致 拒收 LED color is inconsistent after lighting Reject	A	電訊 Electronics	次要 Minor AQL0.65%
13	亮度不足 Lack of brightness	波長、色座標、輝度與圖面標示定義不符 拒收 Wave length, chromatic coordinates, brightness don't correspond to the definition of the drawing. Reject	A	電訊 Electronics	主要 Major AQL 0.4%

TFT

14	觸控 Touch	測試時無法點觸或劃，其靈敏度判定則依 SPEC 上定義判定 拒收 It cannot be touched or swiped during the test. Its sensitivity is judged according to the definition on SPEC Reject	A	電訊 Electronics	主要 Major AQL 0.4%
15	尺寸量測 Size Measurement	未依圖面上標示 拒收 No correspond to the indication on the drawing. Reject	ALL	外觀 Appearance	主要 Major AQL 0.4%
16	其他 Other	如發現有上述未定義之不良則與客端簽訂限度樣 If there is another undefined defective situation. It will be listed as others. The inspection standard is according to the golden sample.	ALL	電訊 Electronics 外觀 Appearance	次要 Minor AQL0.65%