



WSE4FP-84161100A00

W4F

MINIATURE PHOTOELECTRIC SENSORS

SICK
Sensor Intelligence.



Illustration may differ

Ordering information

Type	Part no.
WSE4FP-84161100A00	1123901

Other models and accessories → www.sick.com/W4F



Detailed technical data

Features

Functional principle	Through-beam photoelectric sensor
Sensing range	
Sensing range min.	0 m
Sensing range max.	10 m
Maximum distance range from receiver to sender (operating reserve 1)	0 m ... 10 m
Recommended distance range from receiver to sender (operating reserve 2)	0 m ... 7.5 m
Recommended sensing range for the best performance	0 m ... 7.5 m
Emitted beam	
Light source	PinPoint LED
Type of light	Visible red light
Shape of light spot	Point-shaped
Light spot size (distance)	Ø 40 mm (1,000 mm)
Maximum dispersion of the emitted beam around the standardized transmission axis (squint angle)	< +/- 1.5° (at T _a = +23 °C)
Key LED figures	
Normative reference	EN 62471:2008-09 IEC 62471:2006, modified
LED risk group marking	Free group
Wave length	635 nm
Average service life	100,000 h at T _a = +25 °C

Adjustment	IO-Link	For configuring the sensor parameters and Smart Task functions
	Wire/pin	For deactivation of the sender and execution of test logic
Indication	LED blue	BluePilot: Alignment aid
	LED green	Operating indicator Static on: power on Flashing: IO-Link mode
	LED yellow	Status of received light beam Static on: object not present Static off: object present
Part number of individual components	WS04FP-843ZZ1A0ZZZ, 2126123 WE04FP-84161100A00, 2126122	

Safety-related parameters

MTTF_D	574 years
DC_{avg}	0 %
T_M (mission time)	20 years

Communication interface

IO-Link	✓, IO-Link V1.1	
Data transmission rate	COM2 (38,4 kBaud)	
Cycle time	2.3 ms	
Process data length	16 Bit	
Process data structure	Bit 0 = switching signal Q _{L1} Bit 1 = switching signal Q _{L2}	
VendorID	26	
DeviceID HEX	0x800193	
DeviceID DEC	8389011	
Compatible master port type	A	
SIO mode support	Yes	

Electrical data

Supply voltage U_B	10 V DC ... 30 V DC ¹⁾	
Ripple	≤ 5 V _{pp}	
Usage category	DC-12 (According to EN 60947-5-2) DC-13 (According to EN 60947-5-2)	
Current consumption	≤ 20 mA, without load. At U _B = 24 V	
Protection class	III	
Digital output	Number	2 (Complementary)
	Type	Push-pull: PNP/NPN
	Signal voltage PNP HIGH/LOW	Approx. U _B -2.5 V / 0 V
	Signal voltage NPN HIGH/LOW	Approx. U _B / < 2.5 V
	Output current I _{max.}	≤ 100 mA

¹⁾ Limit values.

²⁾ With light/dark ratio 1:1.

Circuit protection outputs	Reverse polarity protected Overcurrent protected Short-circuit protected
Response time	≤ 500 μs
Switching frequency	1,000 Hz ²⁾
Pin/Wire assignment, sender	
Function of pin 4/black (BK)	Input, sender off, LOW active
Pin/Wire assignment, receiver	
Function of pin 4/black (BK)	Digital output, dark switching, object present → output \bar{Q}_{L1} HIGH; IO-Link communication C
Function of pin 4/black (BK) – detail	The pin 4 function of the sensor can be configured, Additional possible settings via IO-Link
Function of pin 2/white (WH)	Digital output, dark switching, object present → output \bar{Q}_{L1} HIGH
Function of pin 2/white (WH) – detail	The pin 2 function of the sensor can be configured, Additional possible settings via IO-Link

¹⁾ Limit values.

²⁾ With light/dark ratio 1:1.

Mechanical data

Housing	Rectangular
Dimensions (W x H x D)	16 mm x 40.1 mm x 12.1 mm
Connection	Cable with M12 male connector, 4-pin, 182 mm
Connection detail	
Deep-freeze property	Do not bend below 0 °C
Conductor size	0.14 mm ²
Cable diameter	Ø 3.4 mm
Length of cable (L)	140 mm
Material	
Housing	Plastic, VISTAL®
Front screen	Plastic, PMMA
Cable	PVC
Male connector	Plastic, VISTAL®
Weight	Approx. 30 g
Maximum tightening torque of the fixing screws	0.4 Nm

Ambient data

Enclosure rating	IP66 (EN 60529) IP67 (EN 60529)
Ambient operating temperature	-40 °C ... +60 °C
Ambient temperature, storage	-40 °C ... +75 °C
Typ. Ambient light immunity	Artificial light: ≤ 15,000 lx Sunlight: ≤ 50,000 lx
Shock resistance	30 g, 11 ms (3 positive and 3 negative shocks along X, Y, Z axes, 18 total shocks (EN60068-2-27))
Vibration resistance	10 Hz ... 1,000 Hz (Amplitude 1 mm, 3 x 30 min (EN60068-2-6))
Air humidity	35 % ... 95 %, Relative humidity (no condensation)
Electromagnetic compatibility (EMC)	EN 60947-5-2
Resistance to cleaning agent	ECOLAB

UL File No.	NRKH.E181493 & NRKH7.E181493
--------------------	------------------------------

Smart Task

Smart Task name	Base logics
Logic function	Direct AND OR
Timer function	Deactivated On delay Off delay ON and OFF delay Impulse (one shot)
Inverter	Yes
Switching frequency	SIO Logic: 800 Hz ¹⁾ IOL: 750 Hz ²⁾
Response time	SIO Logic: 600 µs ¹⁾ IOL: 650 µs ²⁾
Repeatability	SIO Logic: 200 µs ¹⁾ IOL: 250 µs ²⁾
Switching signal	
Switching signal Q _{L1}	Switching output
Switching signal \bar{Q}_{L1}	Switching output

¹⁾ Use of Smart Task functions without IO-Link communication (SIO mode).

²⁾ Use of Smart Task functions with IO-Link communication function.

Diagnosis

Device temperature	
Measuring range	Very cold, cold, moderate, warm, hot
Device status	Yes
Detailed device status	Yes
Operating hour counter	Yes
Operating hours counter with reset function	Yes
Quality of teach	Yes

Classifications

eCl@ss 5.0	27270901
eCl@ss 5.1.4	27270901
eCl@ss 6.0	27270901
eCl@ss 6.2	27270901
eCl@ss 7.0	27270901
eCl@ss 8.0	27270901
eCl@ss 8.1	27270901
eCl@ss 9.0	27270901
eCl@ss 10.0	27270901
eCl@ss 11.0	27270901
eCl@ss 12.0	27270901
ETIM 5.0	EC002716

ETIM 6.0	EC002716
ETIM 7.0	EC002716
ETIM 8.0	EC002716
UNSPSC 16.0901	39121528

Connection type

Connector M12, 4-pin, A-coded

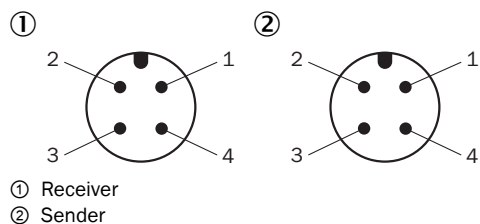

Connection diagram

Cd-516

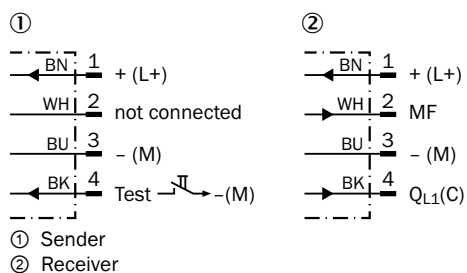

Truth table

Push-pull: PNP/NPN – dark switching \bar{Q}

	Dark switching \bar{Q} (normally open (upper switch), normally closed (lower switch))	
	Object not present → Output LOW	Object present → Output HIGH
Light receive	✓	✗
Light receive indicator	☉	✗
Load resistance to L+	⚠	✗
Load resistance to M	✗	⚠

Push-pull: PNP/NPN - light switching Q

	Light switching Q (normally closed (upper switch), normally open (lower switch))	
	Object not present → Output HIGH	Object present → Output LOW
Light receive	☑	☒
Light receive indicator	☑	☒
Load resistance to L+	☒	⚠
Load resistance to M	⚠	☒

Characteristic curve

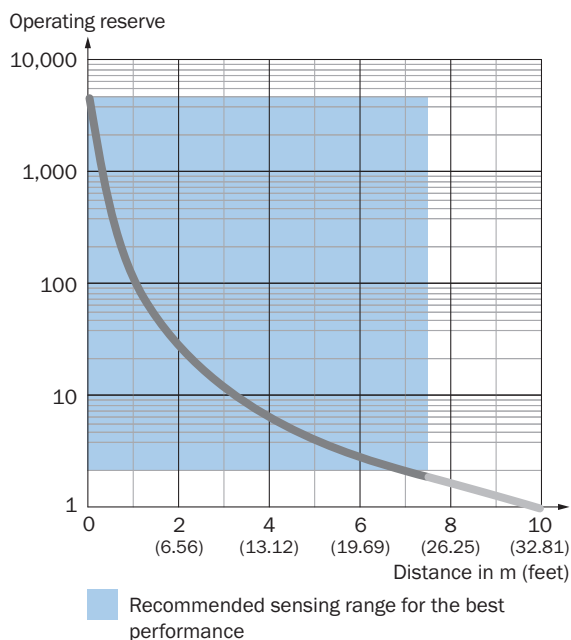

Light spot size

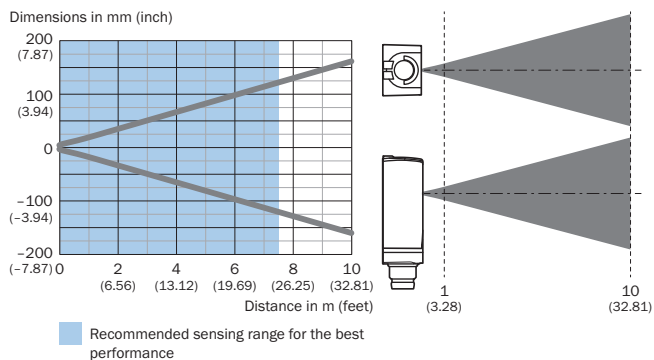

Sensing range diagram

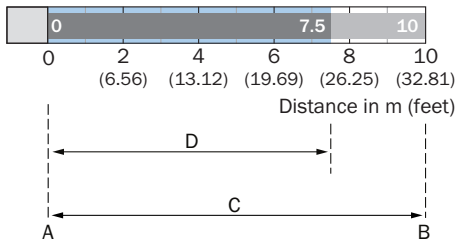

- A = Sensing range min. in m
 - B = Sensing range max. in m
 - C = Maximum distance range from receiver to sender
 - D = Recommended distance range from receiver to sender
- Recommended sensing range for the best performance

Adjustments

Display and adjustment elements

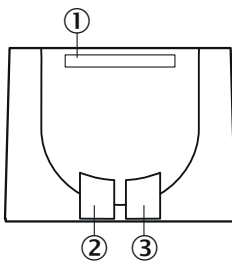

- ① LED blue
- ② LED green
- ③ LED yellow

Dimensional drawing (Dimensions in mm (inch))

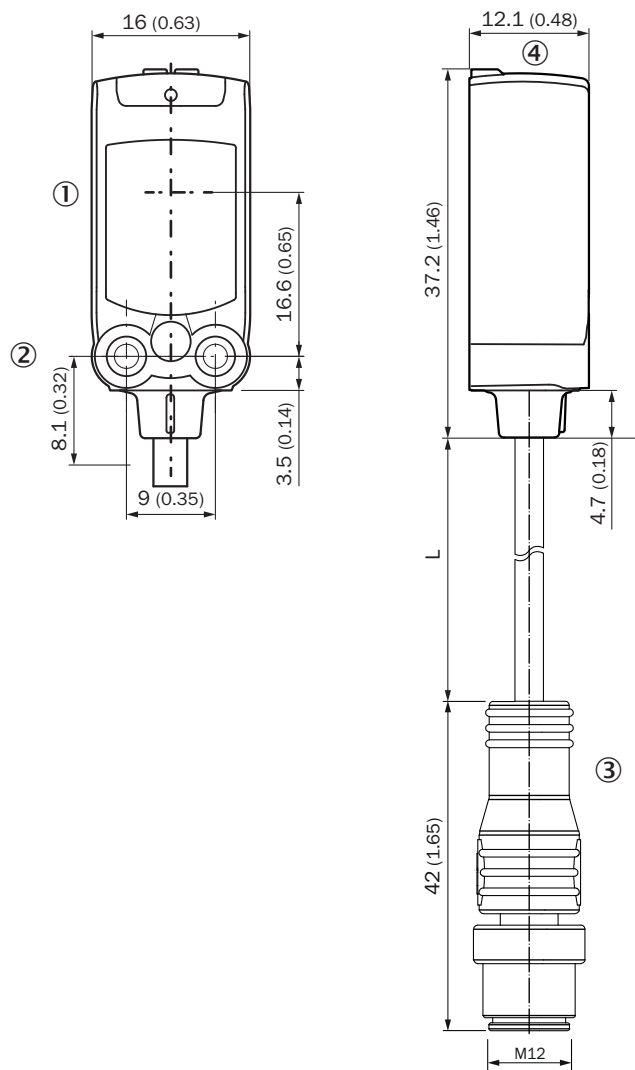



For length of cable (L), see technical data

- ① Center of optical axis
- ② M3 mounting hole
- ③ Cable with M12 male connector
- ④ Display and adjustment elements

Recommended accessories

Other models and accessories → www.sick.com/W4F

	Brief description	Type	Part no.
Mounting brackets and plates			
	Mounting bracket for wall mounting, Stainless steel 1.4571, mounting hardware included	BEF-W4-A	2051628

	Brief description	Type	Part no.
Plug connectors and cables			
	Head A: female connector, M12, 4-pin, straight, A-coded Head B: Flying leads Cable: Sensor/actuator cable, PVC, unshielded, 5 m	YF2A14-050VB3XLEAX	2096235
	Head A: male connector, M12, 4-pin, straight Cable: unshielded	STE-1204-G	6009932

SICK AT A GLANCE

SICK is one of the leading manufacturers of intelligent sensors and sensor solutions for industrial applications. A unique range of products and services creates the perfect basis for controlling processes securely and efficiently, protecting individuals from accidents and preventing damage to the environment.

We have extensive experience in a wide range of industries and understand their processes and requirements. With intelligent sensors, we can deliver exactly what our customers need. In application centers in Europe, Asia and North America, system solutions are tested and optimized in accordance with customer specifications. All this makes us a reliable supplier and development partner.

Comprehensive services complete our offering: SICK LifeTime Services provide support throughout the machine life cycle and ensure safety and productivity.

For us, that is “Sensor Intelligence.”

WORLDWIDE PRESENCE:

Contacts and other locations –www.sick.com