



FEATURES

- Chassis level power terminals – No need for specially routed power cables, special bus bars, or special lugs.
- Rugged **EPIC®** seal rated to 175°C – Reduced risk of fire or meltdown in over current conditions. The same technology used for advanced aerospace programs.
- Hermetically sealed – Designed to meet: UL1604 for Class I & II, Div 2 and Class III for use in hazardous locations, IP67 for temporary water immersion for 30 min, IP69K for pressure washing, SAE J1171 - external ignition protection, and ISO8846 for protection against ignition around flammable gasses.
- High Efficiency Dual DC Coils – Very low 12 or 24 VDC continuous coil power with no EMI emissions or cross-talk on your system control power. Ideal for battery powered systems or where low power is needed.
- Built-in coil suppression for all DC coils – Saves you engineering time and parts cost to add external coil suppression.
- Stainless steel nuts and mounting inserts, for years of corrosion free service.
- Not position sensitive – can be mounted in any position for ease of installation.

PRODUCT SPECIFICATIONS

Specifications	Units	Data
Contact Arrangement		
Main	Form X	SPST-NO
Auxiliary (2A, 24VDC) ¹	Form A or B	SPST-NO or SPST-NC
Mechanical Life		
	Cycles	1,000,000
Contact Resistance²		
Max	mohms	0.4
Typical	mohms	0.15 to 0.3
Operate Time³		
Max	ms	20
Typical	ms	13
Release Time, Max		
	ms	12
Insulation Resistance⁴		
	Mohms	100
Dielectric At Sea Level (Leakage < 1mA)		
	VRMS	2,200
Shock, 1/2 Sine, 11ms		
	G peak	20
Vibration, Sinusoidal (500-2000 Hz Peak)		
	G	15
Ambient Temp Range		
Operating ⁵	°C	-55 to +85
Storage	°C	-70 to +150
Weight, Typical		
	Kg (Lb)	0.73 (1.6)
Environmental Seal		
		Exceeds IP67 & IP69K
Salt Fog		
		MIL-STD-810

POWER SWITCHING AND CURRENT CARRY RATINGS

DC POWER SWITCHING CYCLES⁹

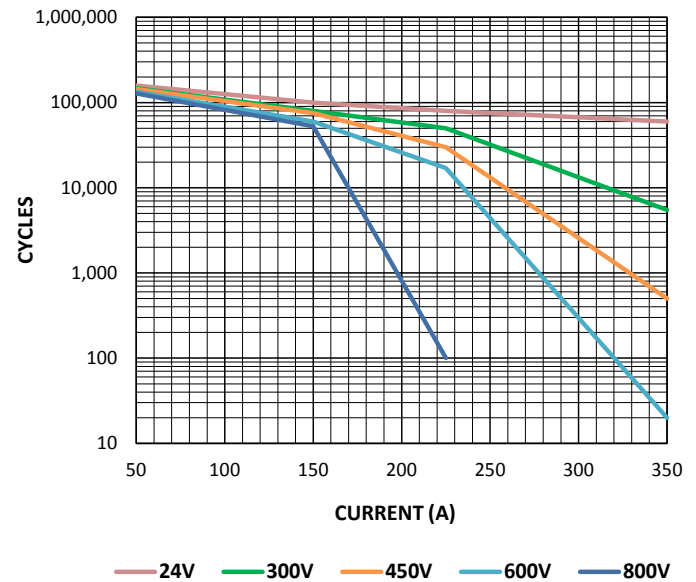

COIL RATINGS at 25°C

Coil P/N Designation	B	C
Coil Voltage, Nominal	12 VDC	24 VDC
Coil Voltage, Max	16 V	32 V
Pick-Up Voltage, Max ^{6, 8}	8 V	16 V
Drop-Out Voltage	0.5 to 4 V	2 to 7.5 V
Pick-Up Current, Max (75 ms) ^{6, 7}	3.9 A	1.6 A
Coil Current ⁷	0.23 A	0.097 A
Coil Power ⁷	2.8 W	2.3 W
Coil Back EMF ¹⁰	0 V	
Transients, Max (13 ms)	±50 V	
Reverse Polarity	16 V	32 V

CURRENT CARRY vs TEMPERATURE
with 4/0 AWG conductor

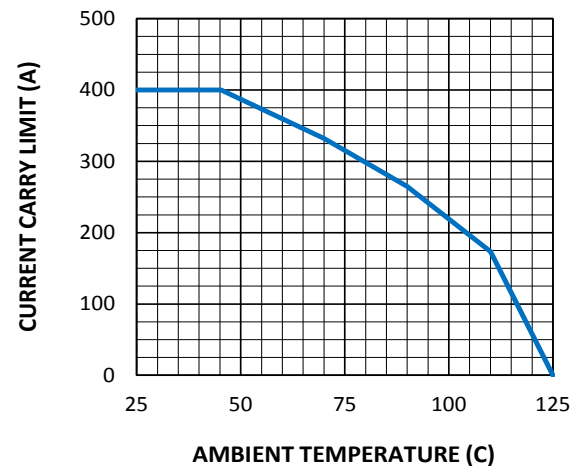

DIMENSIONS

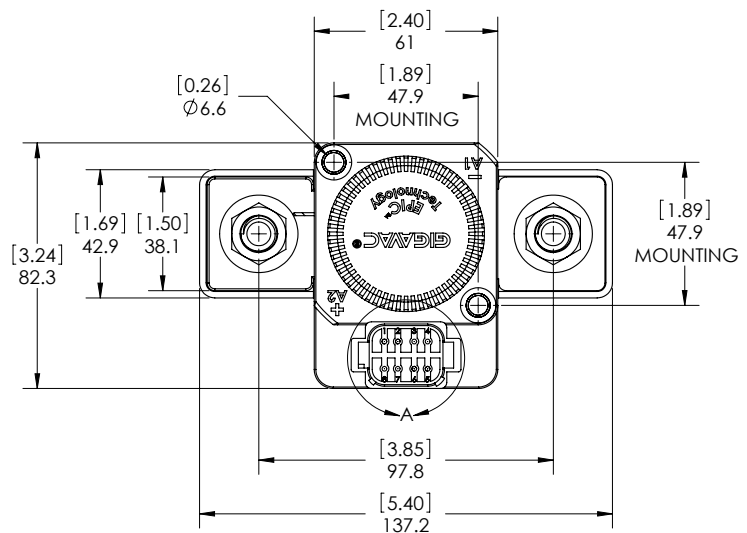
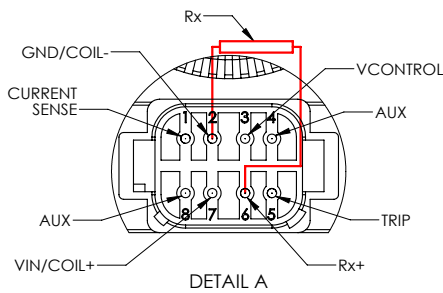

Mounting

M6 Bolts

Case Material

DuPont Zytel FR50
 (25% Glass Filled Nylon)

Power Connection

Zinc Plated M12x1.75 Bolt
 Stainless M12x1.75 Flanged Nut

Torque 23-34Nm [200-300in-lb]

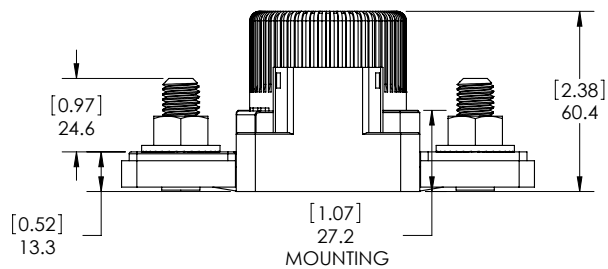

Mating Connector

Gigavac offers the required mating connector as an assembled unit (0857-3/4) or as a component package, see Accessories.

Deutsch Connector Housing P/N: DT06-08SA
 Solid Contact Socket P/N: 0462-201-16141
 Wedge Lock P/N: W8S
 Sealing Plug P/N: 114017
 Crimp Tool P/N: HDT-48-00

Power Contacts

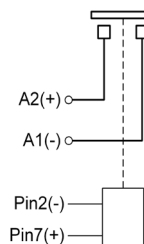

Auxiliary contacts (optional)

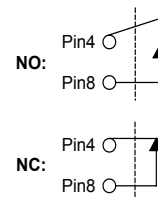

PART NUMBER SYSTEM

350+ Amp 12-800 Vdc
EPIC® Hermetic Sealed DC Contactor | **GXSA15**

GXSA15	B	E	B
Coil Voltage	B = 12 Vdc, Internal Coil Suppression		
	C = 24 Vdc, Internal Coil Suppression		
Coil Termination		E = 8 Pin Deutsch Connector	
Auxiliary Contact			Blank = None
			B = SPST, NO
			C = SPST, NC

APPLICATION NOTES

- Power switching lifecycles are based on **current flow** from A2(+) to A1(-). For best breaking performance, the contactor should be installed so that current flows from A2(+) to A1(-). There are cases where the contactor will interrupt power in the opposite direction but please contact GIGAVAC to confirm suitability. Direction of current flow is not relevant during make or when flowing on closed contacts. For bi-directional contactors, please contact GIGAVAC.
- Applications with **capacitors** will require a pre-charge circuit.
- Electrical life rating is based on resistive load with 27µH maximum inductance in circuit. Because your application may be different, we suggest you test the contactor in your circuit to verify life is as required.
- End of life is defined as when the dielectric, insulation resistance or contact resistance fails the specifications listed.

OVER CURRENT OPERATION

- With power applied to Vin, the contacts will close when Vcontrol is greater than Vcontrol:Close and open when Vcontrol is less than Vcontrol:Open (see Settings Parameters for values). Connect Vcontrol to Vin to disable logic level control.
- When the trip limit is exceeded the contacts will open and the Trip indicator line will go low. The TRIP pin is an open drain. After a trip, Vcontrol needs to be brought low to reset the contactor.
- Connect resistor Rx as shown in red to set the current trip level. Choose Rx using the equation in Settings Parameters. No resistor = 600A.
- Current Sense: Indicates the current through the main contacts (A2 and A1). The current sense range is from -600 to +600 amps.

$$\text{Pin 1: } 0\text{V to } 5\text{V, } V_{\text{out}} = (I/240) + 2.5$$

SETTINGS PARAMETERS

Parameter	Units	Data	
Coil Voltage		B	C
Vin Input Voltage Range	V	10-16	20-30
Vcontrol Pin Input Resistance	Ω	10k with 100k pull down	
Vcontrol:Close	V	2.5-32	
Vcontrol:Open	V	0-1.5	
Current Trip Setting Range	A	±(20-600)	
Rx Value (I_Trip is the trip level in A)	A	$R_x = 100k\Omega * I_{\text{Trip}} / 600A$	
Current Sense Accuracy		±7%	
Over Current Response Time	ms	2ms + release time	
Max Sink Current on Trip Pin	mA	10	

Notes & Definitions:

- Auxiliary contact rating is 2A, 24Vdc Resistive load, 100,000 cycles. Minimum current is 0.1mA, 5V. The auxiliary contact is mechanically linked to the main power contacts.
- Contact resistance measured at currents higher than 100A.
- Operation time is measured at 25°C and includes maximum 7ms bounce.
- Insulation resistance is 50 Mohms after life.
- Contactors can operate up to 125°C in special cases - contact GIGAVAC for details.
- Contactors have two coils. Both are used for pick-up, and then in approximately 75 milliseconds, one coil is electronically removed from the coil drive circuit. The remaining coil supplies low continuous hold power sufficient for the contactor to meet all of its specified performance specifications. This provides low coil power without PWM electronics that can cause EMI emissions and/or cross-talk on control power.
- Contactors are operated by a coil that changes resistance with temperature. Since pick-up current, coil current and coil power are specified at nominal voltage, they will be lower than indicated at temperatures above 25°C and higher than indicated at temperatures below 25°C. Similarly, pick-up and drop-out voltages will be higher than indicated at temperatures above 25°C and lower than indicated at temperatures below 25°C.
- For pick-up testing of contactors with dual coils, the voltage can not be ramped up slowly, but must be applied instantly to at least the maximum pick-up voltage. Otherwise, the contactor will not pick-up.
- Limit make current to 600A to avoid contact welding. For AC power switching cycles, contact factory.
- Coils are switched internally with a FET, so no fly-back/suppression voltage is seen at the coil inputs.

