



AN1018: Using the Si72xx Hall-effect Magnetic Position Sensors

This application note describes the use of the Si72xx family of Hall-effect magnetic field sensors. These devices can be used for position sensing, rotational position sensing, revolution counting, security systems, cover position, sealed on/off switching and linear position sensing.

These devices all measure magnetic field in the axis perpendicular to the package. All of these parts share the attributes of low power, high sensitivity, and low noise. The simplest parts in this family have a single output pin that goes high or low at a certain magnetic field. Options are available to output the magnetic field by I²C, SENT, PWM or analog format, to put the part in a very low power sleep state (disable pin), to turn on an on-chip test coil (BIST) and to indicate when a higher than expected field has been detected (tamper).

Note: In this document we use mT or milli-Tesla for the units of magnetic field. 1 mT is 10⁻³ Tesla or 10 Gauss.

KEY POINTS

- Discusses types of magnetic field sensors
- Shows possible magnet configurations
- Explains how to replace reed switches
- Suggests ways to optimize the magnet
- Discusses nearby ferromagnetic materials and magnetic fields
- Discusses layout considerations
- Explains offset, noise, and hysteresis
- Describes the tamper detection feature
- Explains position measurement
- Shows how to use the quadrature decoder
- Shows how to calculate sample rate and averaging
- Describes how to use an I²C part to generate an interrupt
- Offers code examples
- Explains how to choose operate and release points

1. Part Types

The Si72xx series of magnetic field sensors come in three basic types:

1. Si720x switches and latches

These devices periodically sample the magnetic field and have a digital output pin that goes high or low at a certain magnetic field. Five-pin packages have the option of disabling the part (putting it in a lower power mode) and a second output that goes high at a different (higher) field (tamper indication). Tamper indication for three-pin parts is by the output pin being set to the zero field value.

2. Si721x analog, PWM and SENT output

These devices periodically sample the magnetic field and output the data on a pin in either analog, pulse width modulation (PWM), or Single Edge Nibble Transmission (SENT) protocol. Five-pin packages have the option of disabling the part (putting it in a lower power mode) and activating an on-chip built in self-test coil (BIST).

3. Si7210 I²C sensors

These devices allow the digital reading of the magnetic field in I²C format. I²C commands can also be used to configure the part. Five-pin devices also have the output pin, which can go high or low to act as an interrupt, or the 5th pin can be used to output the field in analog format.

The Si72xx devices are available in SOT23 three or five-pin packages, a 1.4 mm×1.6 mm×0.35 mm dual-flat no-leads, 8-pin package (DFN-8) and a TO-92 package.

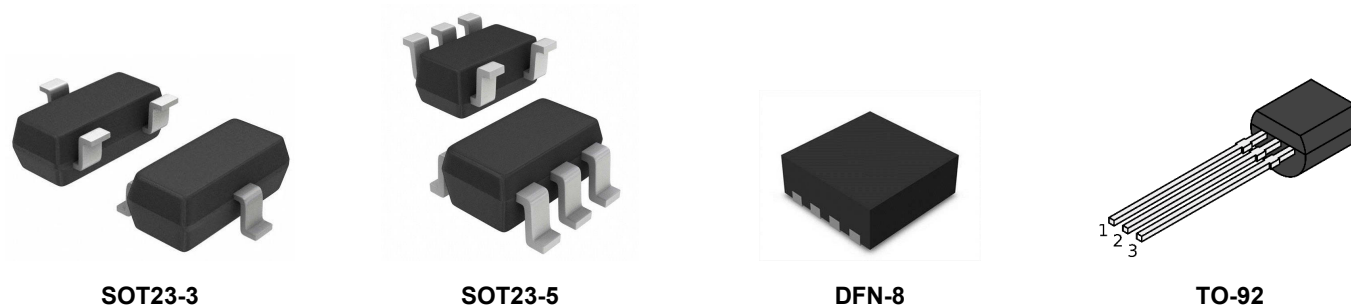

Figure 1.1. Part Types

The devices are sensitive to magnetic field in the direction normal (perpendicular) to the package. The Si72xx parts can be configured to be sensitive to the magnitude of the field in this direction (omnipolar), or to be sensitive to the magnitude and sign of the magnetic field in this direction (unipolar). For the SOT23 and DFN-8 packages, positive magnetic field is defined as North pole at the bottom of the package (field lines from PCB side to top side). For the TO-92 package, positive magnetic field is defined as North pole to the front of the package (marking side).

2. Magnet Configurations

There are two possible ways to position the sensor relative to the magnet:

1. **Magnet-pole-facing sensor**
2. **Magnet beside sensor**

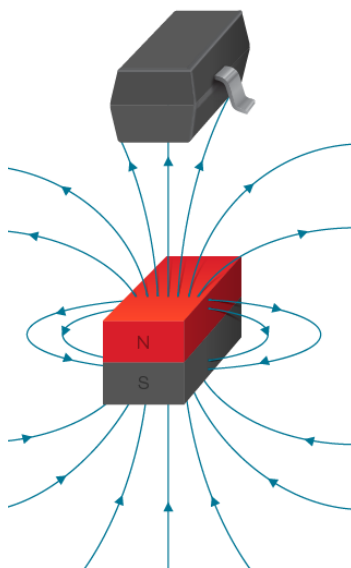

Figure 2.1. Magnet-Pole-Facing Sensor

Generally, the magnet-pole-facing sensor configuration gives the highest field at a given distance from the magnet. However, the field lines in this direction are more concentrated so that if the sensor is misaligned the fields drop off more quickly.

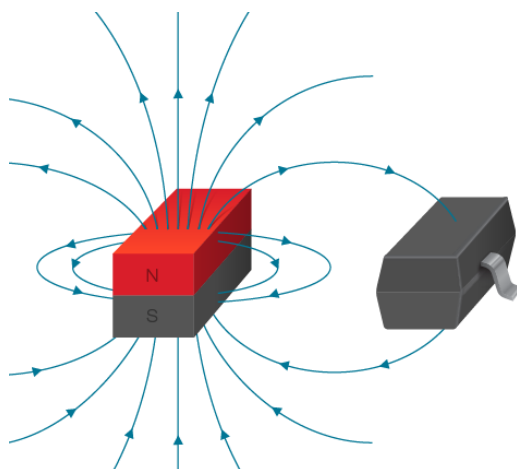

Figure 2.2. Magnet Beside Sensor

In the magnet-beside-sensor configuration, the field lines cross the device in the opposite direction as the magnet alignment. This configuration generally gives slightly weaker field at a given distance, but is less sensitive to alignment. The configuration also allows greater mounting flexibility because the sensor can be mounted away from any of the four non-pole magnet faces, while the first configuration requires the sensor to be mounted above or below a pole face.

Mounting configurations that do not result in the field crossing in the correct direction will give little to no response.

3. Replacing Reed Switches

Due to their high sensitivity, low power, and solid state durability, the Si72xx Hall-effect magnetic field sensors make excellent replacements for reed switches.

Reed switches work when a magnet induces a polarization in the ferromagnetic reed elements causing them to attract each other:

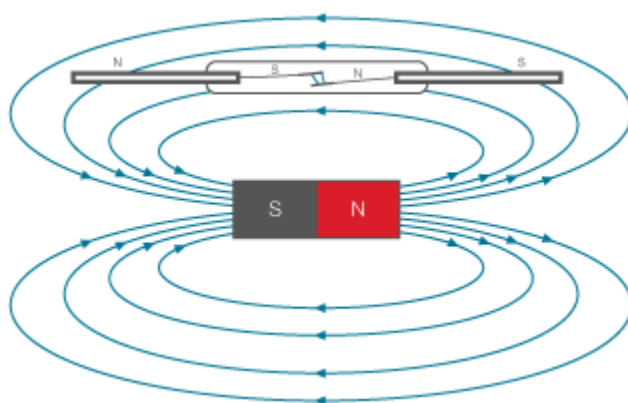

Figure 3.1. Reed Switch

The magnet and reed are placed side-by-side in a configuration. The magnet is usually a bar or rod shape about the length of the reed switch. If the magnet and reed switch are misaligned, the magnet must be held closer.

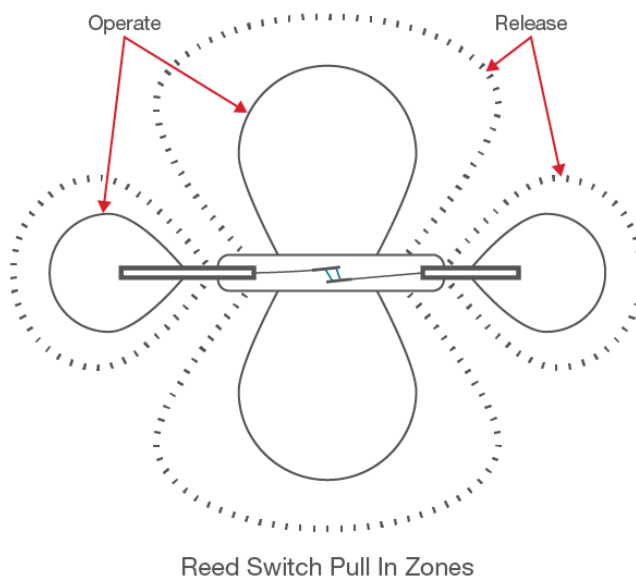

Figure 3.2. Reed Switch Pull-In Zones

This type of magnet is not optimized for a Hall-effect sensor. A typical configuration with the magnet beside the sensor in a SOT23 package will not work.

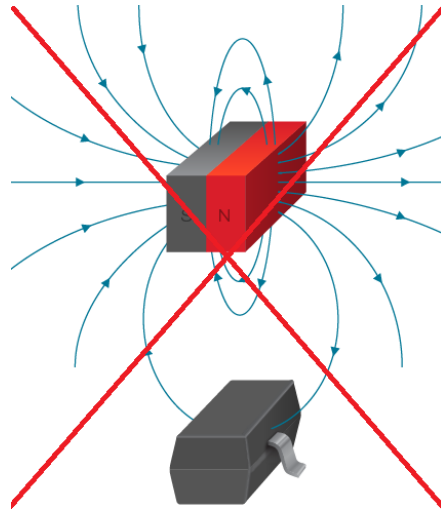
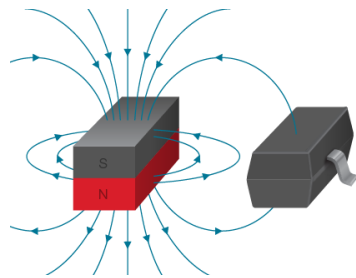
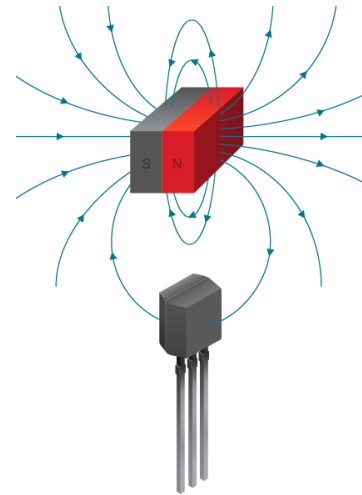

Figure 3.3. Magnet Not Optimized for Hall-effect Sensor

Either the magnet polarization would need to be changed to up and down instead of side to side, or the TO-92 package should be used.



SOT2-3 and WLCSP magnet configuration



TO-92 magnet configuration

Figure 3.4. SOT23, DFN-8 and TO-92 Magnet Configuration

Reed switch sensitivity is typically rated in ampere-turns (A-T) — how many turns of wire carrying 1 amp wrapped around the reed switch as a solenoid are required to activate the reed. There is not a precise relationship between the A-T rating of a reed relay and the peak field generated by the magnet for a reed switch. A good rule of thumb is that for a magnet optimized for a reed switch, the peak field at the reed switch will be about 1 mT for every 10 AT of sensitivity. As an example, here is some characterization data on a very sensitive reed switch rated for a sensitivity of between 6 and 8 A-T.

Table 3.1. Reed Switch with Sensitivity between 6 and 8 A-T

AlNiCo 5 Magnet Size (mm)	Magnet Volume (mm ³)	Pull-in Distance (mm)	Calculated Field at Pull-In (mT)
1.57 × 1.57 × 12.7	31	10	1.4
3.2 × 3.2 × 19.5	200	20	1.3
4.76 × 4.76 × 25.4	575	33	0.95
6.35 × 6.35 × 25.4	1024	43	0.81

The Si72xx parts have a sensitivity of approximately 1.1 mT (depending on part number). For the TO-92 package which has the correct orientation for these kind of magnets, the sensitivity is equivalent to this very sensitive reed switch. For the TO-92 packages, the magnet does not have to be as long and thin as it is for a reed switch and some optimization can be achieved by making the magnet shorter with the same volume.

For the SOT23 and WLCSP packages, the magnet must be correctly polarized and correctly shaped, as discussed above. If it is, the sensitivity (pull in distance) will be about the same for a given magnet volume. The SOT23 and WLCSP packages are surface mount (generally lower assembly cost) and have the advantage that they can be mounted closer to the PCB edge. In this mounting configuration, the Hall-effect parts are sensitive along the entire magnet periphery while the reed switches and TO-92 package will have “dead zones”, as illustrated above.

4. Optimizing the Magnet

Magnets can be made from a wide variety of materials ranging from inexpensive ceramics to rare earth materials like Neodymium. The property of magnetic materials that determines how much field can be generated after magnetization is the residual flux density Br. Here is a listing of Br for typical magnet materials:

Table 4.1. Br Values for Typical Magnet Materials¹

Material	Br minimum (mT)	Br typical (mT)
Y10T (ceramic)	200	235
Y32 (ceramic)	400	420
Sintered AlNiCo 5 (Aluminum Nickel Cobalt)		1090
N35 (Neodymium)	1170	1210
N42 (Neodymium)	1290	1320

Note:

1. These numbers are representative and can vary with magnet manufacturer.

The magnetic field generated at a given distance from a magnet of a given size is proportional to Br. Other important parameters of magnetic material include the operating temperature, temperature coefficient of magnetic field, and field strength to magnetize or demagnetize the magnet.

The most important parameter determining the distance to achieve a given magnetic field is the physical size of a magnet. Increasing the size of a magnet by a given amount in each direction x,y,z will increase the distance for a given magnetic field by the same amount. For example a cube of N42 5×5×5 mm can achieve a working distance of 22 mm. To double this distance, increase the magnet to 10×10×10 mm.

Field strength drops off very rapidly with distance from a magnet. Due to this, the working distance that can be achieved increases slowly with Br. For example, consider a 5×5×5 mm magnet. At a 1 mT field strength, the working distance from the side of the magnet (configuration 2) is:

Table 4.2. Working Distance from Side of Magnet

Material	Br Typical (mT)	Working Distance for 1.1mT from the Side of a 5×5×5 mm Magnet
Y10T (ceramic)	235	10.5 mm
Y32 (ceramic)	420	13.3 mm
N42 (Neodymium)	1320	22 mm

There is very little variation in the magnetic field as the magnet is changed from cube shaped to bar or slab shapes. Consider a magnet with constant volume as “a” and “b” vary, as shown below:

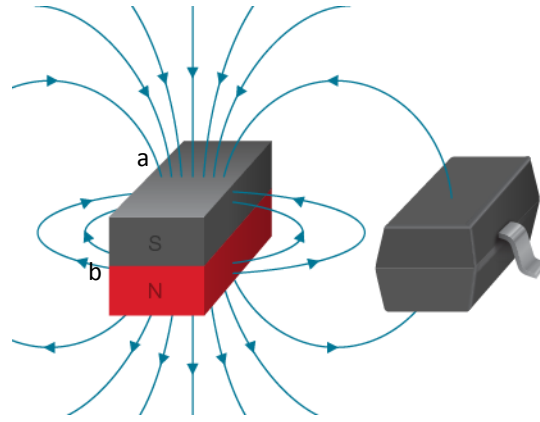

Figure 4.1. Magnet with Constant Volume

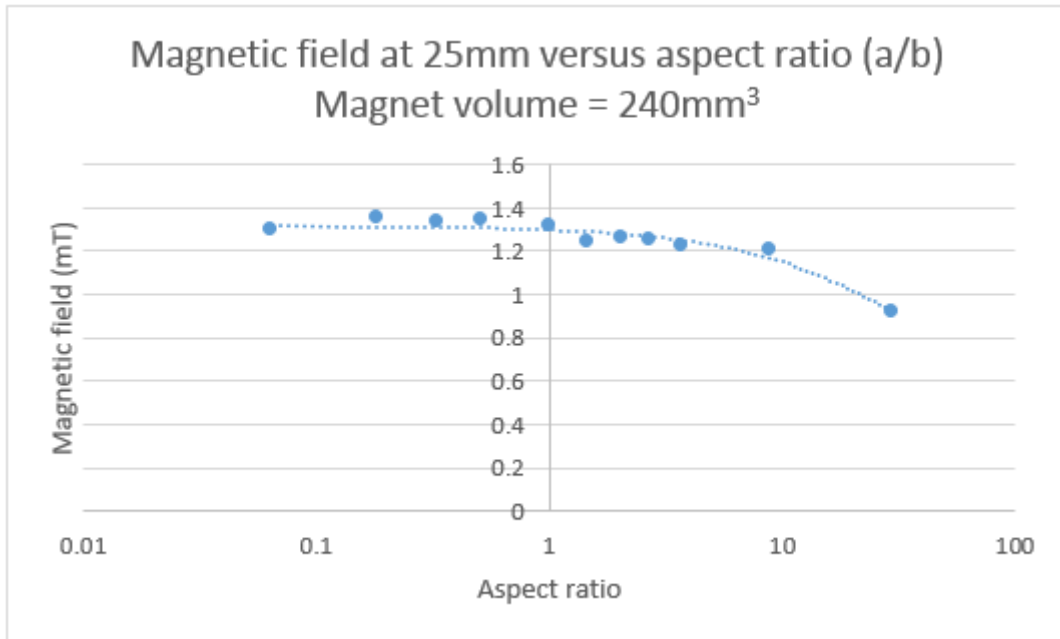

Figure 4.2. Magnetic Field Changes

To summarize, for a design with a sensor that has B_{OP} minimum of 1.1 mT and a side-by-side placement, the following working distances can be expected:

Table 4.3. Working Distance for Side-by-Side Placement

Magnet size (mm)	Magnet material	Working distance from magnet face at 1.1 mT
5 × 5 × 5	N42 Br = 13200 gauss	22 mm
4 × 4 × 8	N42 Br = 13200 gauss	21 mm
5 × 5 × 10	N42 Br = 13200 gauss	26.5 mm
4 × 6 × 10 (magnetization in the 4 mm direction)	N42 Br = 13200 gauss	26 mm
3/8" × 1/4" × 1/8" magnetization in the 1/8" direction	N42 Br = 13200 gauss	23 mm
8 × 8 × 8	Y32 Br = 4200 gauss	21 mm
6 × 6 × 14	Y32 Br = 4200 gauss	21.5 mm
10 × 10 × 10	Y10T Br = 2350 gauss	21 mm
8 × 8 × 16	Y10T Br = 2350 gauss	21.5 mm

For more or less working distance, each magnet face should grow proportionally (working distance goes as the cube root of volume). For other magnet shapes, a first approximation is that working distance will vary as the cube root of volume. For other remnant flux densities, there is not an exact relationship between flux density and distance. Empirically, we have found that an approximation that the distance will vary according to the 0.43 power of remnant flux density.

$$x = x_0 \times \left(\frac{Br}{Br_0} \right)^{0.43}$$

Alternatively, three-dimensional solvers are available and can be used to evaluate other magnet geometries. Contact Silicon Labs if assistance is needed.

5. Nearby Ferromagnetic Materials and Magnetic Fields

The component of the earth's magnetic field in the sensitive axis is generally less than ± 0.05 mT, but this is generally additive to the sensor offset. Large ferromagnetic structures such as an iron door frame can be partially magnetized and cause a further offset. In switch applications in particular, the background fields and offset of the sensor must be considered when choosing the sensor release point.

Ferromagnetic materials near the sensor can bend and amplify the fields that are present from the magnet. The field bending can reduce or increase the magnetic field normal to the device. This means that the presence of ferromagnetic materials can have the effect of increasing or reducing sensitivity depending on shape and sensor placement.

6. Layout Considerations

For maximum distance from a magnet, the magnetic field sensor should be placed as close as possible to the edge of the PCB, so the PCB can be placed as close as possible to the magnet. The actual Hall plate is close to the center of the package. For a practical layout, this results in the following distances from the sensor area to the board edge:

Table 6.1. Distance from Sensor Area to Board Edge

Package Type	Center of Package to Board Edge
SOT23	75 mil (2 mm)
WLCSP	35 mil (1 mm)
TO-92	85 mil (2.2 mm)

These distances, plus any additional distance associated with a case for the PCB or magnet, must be accounted for when calculating how far apart the magnet and magnet holder can be from the PCB and case.

A common consideration for door and window sensors is the placement of the battery, which is often magnetic. Measurements with a CR2032 coin cell show a slight reduction in magnetic fields at the sensor for the sensor in the range of 2 to 6 mm from the coin cell edge due to the bending effect. If the sensor is placed completely under the coin cell we have seen a 25% increase in field strength due to the amplification effect.

Generally, placement of the sensor completely under the battery is undesirable simply because this places the sensor further from the board edge and the amplification effect is not strong enough to compensate. For these reasons, we recommend the sensor is placed at the edge of the battery or more than 8 mm away from the edge of the battery.

7. Offset, Noise, and Hysteresis

Each sensor measurement will vary from the actual magnetic field by the offset (including sensor offset and offset from background fields) plus or minus conversion noise.

The conversion noise of the Si72xx sensors is $\pm 30 \mu\text{T}$ (1 sigma) at V_{DD} of 5 V. The conversion noise varies with V_{DD} according to:

$$\text{noise} = 30\mu\text{T} \times \left(\frac{5\text{V}}{V_{DD}} \right)$$

So, at V_{DD} of 1.7 V, the noise increases to $90 \mu\text{T}$ (1 sigma). For high voltage devices, V_{DD} is 5 V or the applied voltage minus 1 V, whichever is smaller.

Averaging can be used to reduce the effect of noise. The Si72xx have programmable on-chip averaging. Noise is reduced as the square root of the sample size for averaging. The averaging can be done for measurements in a burst (FIR average) or by (IIR style averaging). Taking a burst of measurements will increase power, while IIR averaging can introduce latency.

For switches, the data sheet specifications for operate and release points include offset variation of the part, but do not include the effect of noise.

Consider a typical part with no averaging, B_{OP} minimum of 0.2 mT, B_{RP} maximum of 1.1 mT and hysteresis of 0.4 mT. To allow for the $\pm 250 \mu\text{T}$ offset variation, the typical operate and release points are set to 0.85 mT and 0.45 mT, and the maximum release point can be 0.7 mT and minimum operate point can be 0.6 mT.

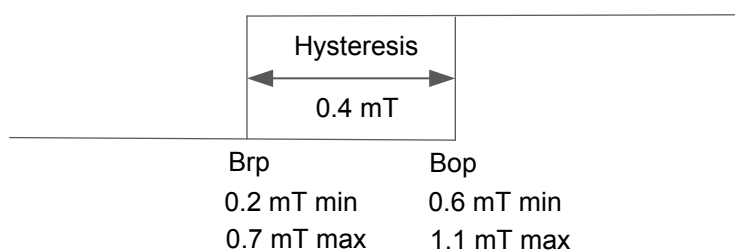

Figure 7.1. Typical Operate and Release Points

With just the earth's magnetic field of 0.05 mT maximum, the minimum operate point of 0.6 mT is 0.55 mT away and the 0.09 mT noise at the worst case low supply of 1.7 V is over six sigma away so that false operations will not happen.

As the field increases towards the operate point, it becomes increasingly likely that that part will operate. Once the field reaches the operate point, there is a 50% chance it will operate on the first measurement.

Given the maximum release point of 0.7 mT, the magnet's field would have to be maintained at 1.3 mT to be six sigma away from the release point at worst case low battery.

For a typical part with a release point of 0.45 mT and a typical power supply of 3.0 V (conversion noise is $50 \mu\text{T}$ RMS), a field strength of 1 mT is sufficient to put the release point six sigma away.

If the part has operated and the field is returning to zero, the measured value will be the actual field plus or minus noise. At zero field and worst case low battery, there is a 2.275% chance (two sigma) that the part would not release on the first measurement. After a few measurements the part will release.

With no averaging and operation to 1.7 V, B_{RP} min of 0.2 mT and B_{OP} max of 1.1 mT is a practical lower limit. It is possible to further reduce the operate and release points by adding averaging, reducing operating temperature range, increasing V_{DD} or by using an I^2C part which can be calibrated for offset at the time of installation.

8. Tamper Detection

The tamper detection feature of the Si72xx parts is a second threshold that is intended to indicate the presence of an unexpectedly large magnetic field. The intent is to indicate the possibility that an intruder has tried to fool an alarm system with a large magnet. The scenario is that the intruder places a large magnet near the sensor to keep it activated and then opens a door. There could be other situations where it is desirable to detect the presence of an unexpectedly large magnetic field.

For devices that have the tamper detection feature and only have one output pin, tamper detection indication is that the pin returns to its zero field state. For devices that have a separate tamper indication pin, tamper events are reported by the TAMPERb pin going low.

9. Position Measurement

Simple digital output parts give only coarse position, e.g., magnet in close or far proximity.

Parts with analog output or I²C parts can be used to build very sensitive position indicators by arranging the sensor and magnet so that the magnetic field varies quickly as the part passes through it. Alternatively the sensor and magnet can be held in a fixed position relative to each other and the magnetic field can be varied by passing a ferromagnetic “vane” between them. In either case, because the magnetic field varies with position, precise position measurement is possible. An example arrangement is shown in the following figure:

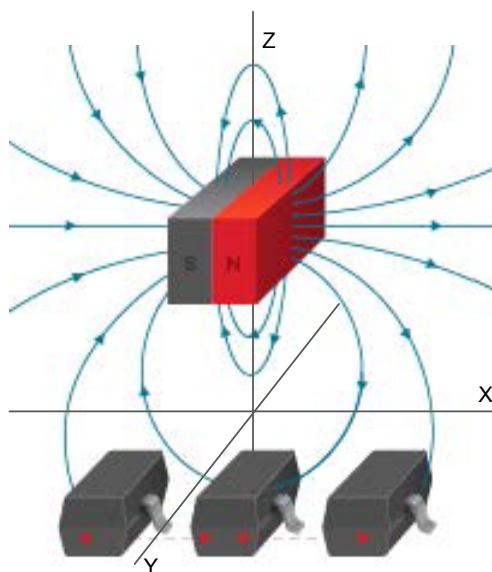

Sensor moving past magnet in X-axis, 8 mm from the magnet in the Z-axis and centered under the magnet in the Y-axis.

Figure 9.1. Measuring Position by Moving the Magnetic Field

In this case, as the sensor moves past the magnet (or visa versa), the field varies as shown in the following figure:

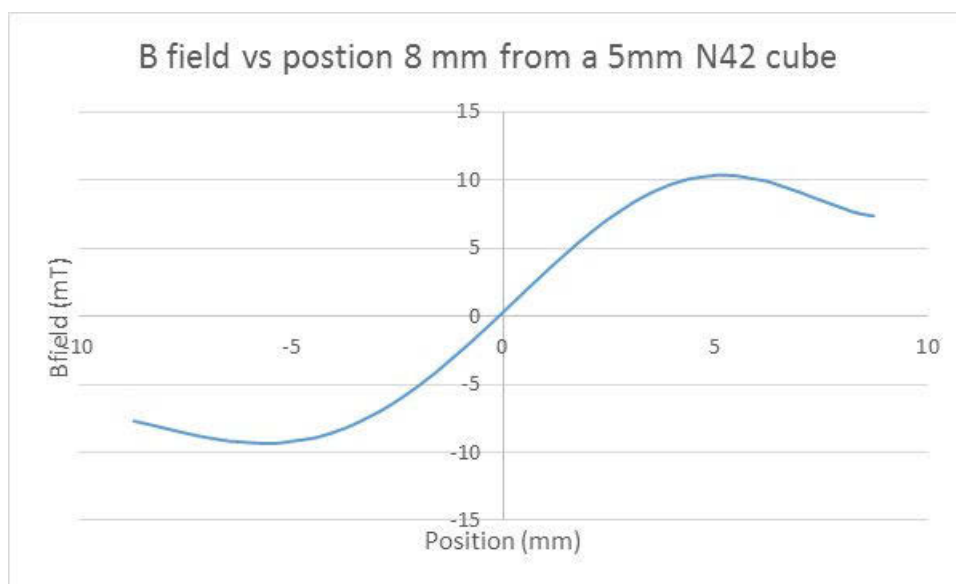

Figure 9.2. Measuring Position by Varying the Magnetic Field

In the narrow region as the field goes from positive to negative, position can be very precisely determined. In this example, 8 mm from a 5 mm N42 magnet face, the field varies in the linear region at approximately 3 mT/mm. With the 30 μ T RMS noise of the sensor (at $V_{DD} = 5$ V) the resolution is about 10 μ m. Smaller magnets and closer spacing can give resolution to as small as 1 μ m.

It is also possible to build rotary position sensors by arranging the Hall sensor to sense the field variation from a magnetic shaft or magnets arranged around a shaft. Two Hall-effect magnetic field sensors arranged at 90° offset so that the magnetic field varies approximately in quadrature, allow easy angle calculation. One such arrangement is shown below. Here, two N42 magnets 1/8" diameter and 1/16" thick were used as field generators—one with pole facing up and one with pole facing down. While one magnet could be used, it was simpler to place two magnets.

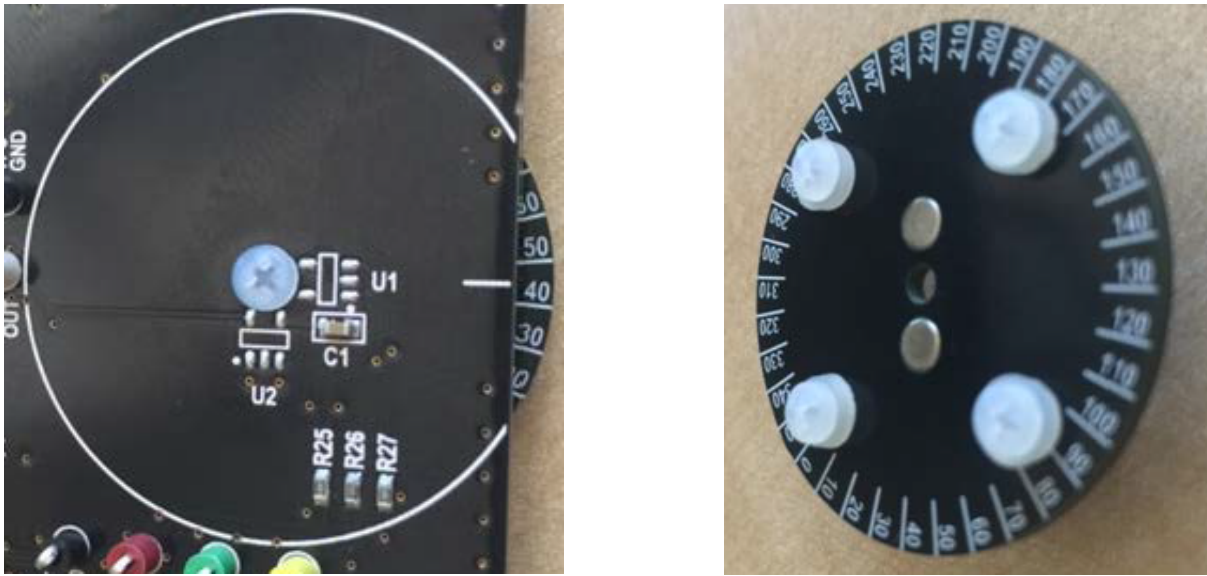

Figure 9.3. Rotary Position Sensors

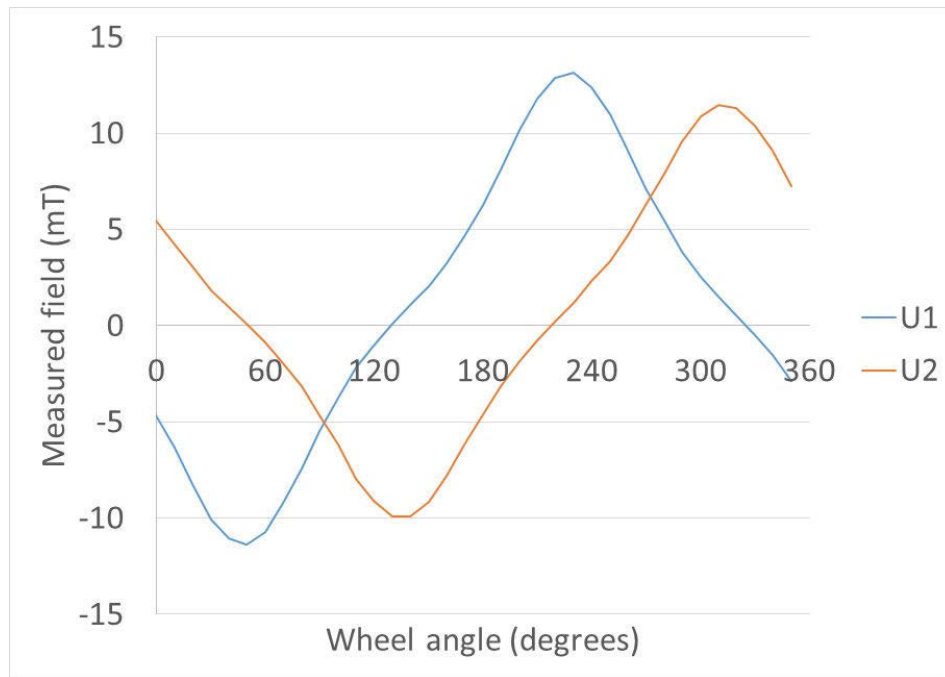

Figure 9.4. Measured Field vs. Wheel Angle

With this arrangement, the field variation is about 0.1 mT per degree so at 30 μ T RMS noise this translates to an angular resolution of about 0.3°. Adding averaging reduces this to 0.1° or less.

The above are only examples of position sensing. There are many possible magnet and sensor arrangements including multiple pole magnets, ferromagnetic elements to bend and amplify fields, gear tooth counting by sensing the passage of ferromagnetic gear teeth, etc. The sensitivity, low noise and gain accuracy of the Si72xx sensors that can output the field value (I²C, analog, PWM or SENT) format make these devices ideal for position sensing applications.

10. Use of Quadrature Decoder for Determining Velocity and Direction

An alternative to position sensing is the use of a quadrature decoder to determine velocity and direction. Approximate position can be derived because it is possible to decode the quadrant of a wheel as well.

Many Silicon Labs 32 bit MCUs have very low power quadrature decoding logic. The principle for this is described in AN0024 and shown in the following figure:

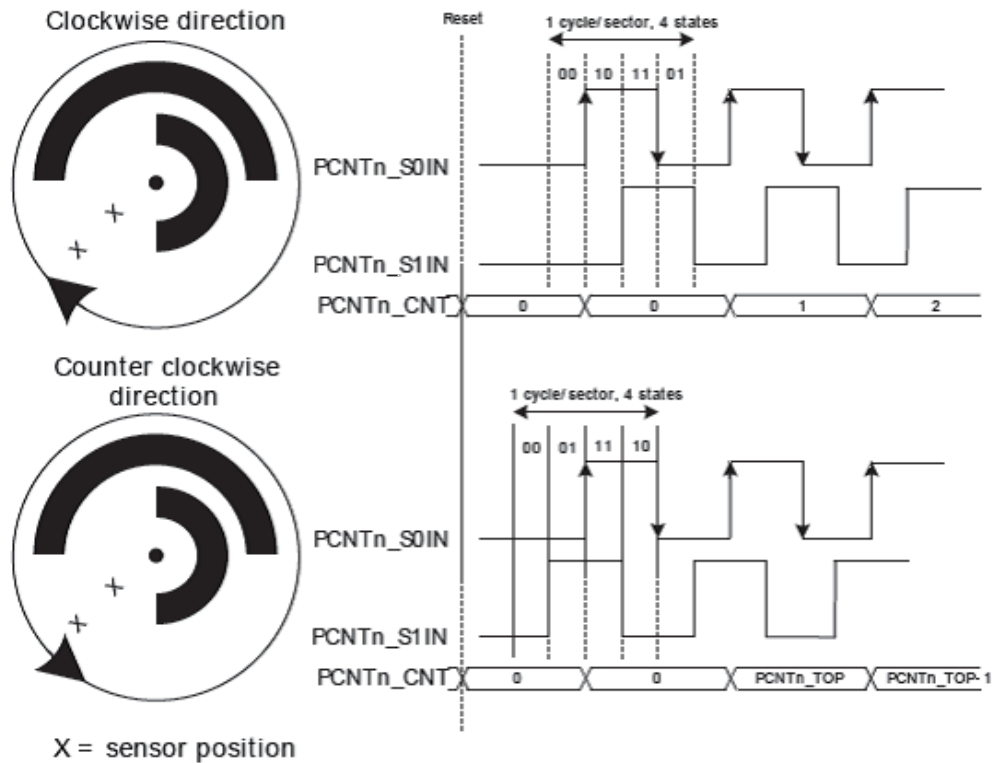

Figure 10.1. Low-Power Quadrature Decoding Logic

The quadrant the wheel is in is determined by looking at the outputs of a pair of Si720x Hall-effect latches or switches.

Table 10.1. Determining Wheel Quadrant

Output 1	Output 2	Quadrant
Low	Low	One
Low	High	Two
High	High	Three
High	Low	Four

The velocity of the wheel is determined by the number of pulses counted between quadrant transitions.

The direction of the wheel is determined by the order in which transitions occur.

Generally, the magnets are arranged so that the magnetic field varies symmetrically around zero as for the wheel position case. The ideal magnetic sensor for this situation is a “latch” type part with the hysteresis region just large enough that noise does not cause high or low transitions when the wheel is not turning. The sample rate needs to be large enough that wheel velocity calculations are not affected due to a lag between the sensor entering a quadrant and the sample.

11. Sample Rate and Averaging

The Si72xx family of sensors have a large range of possibilities for sample rate and averaging. This allows trading speed or response time, noise, and power.

Each individual magnetic field conversion takes 11 μsec . If the conversions are done sequentially, each additional conversion takes 8.8 μsec . While it is possible for the Si72xx devices to work in continuous conversion mode, generally parts are programmed to make one conversion or a burst of a few conversions (which are averaged) and then go to sleep or idle mode for a time period.

While sleep mode between conversions is generally the lowest power option, there are limitations:

- The minimum sleep time is 1 msec.
- Parts that output the data in analog, PWM or sent format must remain in idle mode between conversions.

For parts that have an analog output the magnetic field data is still sampled and internally digitized. The digital value is then converted back to analog. This allows the digital temperature compensation, gain compensation and offset compensation and allows for highly accurate gain and offset. It also means that even for analog output parts power can be saved by idling between conversions. However, note that analog output parts have an added 450 μA bias current for the analog output electronics.

The lowest power parts in the Si72xx family make a single conversion decide whether the output pin should be high or low and then go to sleep between conversions for $t_{\text{sleep}} = 200 \text{ msec}$. The typical supply current for a conversion versus V_{DD} is as follows:

Table 11.1. Typical Supply Current for Conversion vs. V_{DD}

V_{DD}	I_{DD} During Conversion
1.8 V	3.9 mA
3.3 V	5.2 mA
5.0 V	6.6 mA

During the sleep interval, the I_{DD} is 100 nA typical, so the average I_{DD} at 3.3 V is:

$$I_{\text{DDaverage}} = \frac{(11\mu\text{s} \times 5.2\text{mA} + 100\text{nA} \times 200\text{ms})}{200\text{ms} + 11\mu\text{s}} = 0.386\mu\text{A}$$

If more samples are taken and averaged to reduce noise then add 8.8 μs to the conversion time. For example for a four-sample average and 200 ms sleep time, the current would increase to:

$$I_{\text{DDaverage}} = \frac{((11\mu\text{s} + 3 \times 8.8) \times 5.2\text{mA} + 100\text{nA} \times 200\text{ms})}{200\text{ms} + 11 + 3 \times 8.8\mu\text{s}} = 1.07\mu\text{A}$$

Faster sample rates will increase current as well. Consider a sensor designed for counting wheel revolutions that must sample every 1msec. In this case, with no averaging the power is:

$$I_{\text{DDaverage}} = \frac{(11\mu\text{s} \times 5.2\text{mA} + 100\text{nA} \times 1\text{ms})}{(1\text{ms} + 11\mu\text{s})} = 57\mu\text{A}$$

Parts that have analog output, PWM output, SENT output or that sample at a rate faster than 1msec must go into idle state between samples. The idle current for PWM and SENT parts is 360 μA typical. For analog output parts, this increases to 810 μA typical.

Consider for example an analog mode part sampling every 1msec with no averaging (just one sample). The average current would be:

$$I_{\text{DDaverage}} = \frac{(11\mu\text{s} \times 5.2\text{mA} + 810\mu\text{A} \times 1\text{ms})}{(1\text{ms} + 11\mu\text{s})} = 858\mu\text{A}$$

The general formula for idle power is:

$$I_{\text{DDaverage}} = \frac{(11\mu\text{s} + 8.8\mu\text{s} \times (N - 1) \times I_{\text{convert}} + (I_{\text{sleep}} \times t_{\text{sleep}}) \text{ or } (I_{\text{idle}} \times t_{\text{idle}}))}{t_{\text{sleep or tidle}} + 11\mu\text{s} + 8.8\mu\text{s} \times (N - 1)}$$

Where N is the number of samples in a measurement burst.

Some parts are designed to operate in continuous conversion mode. In this case, a new sample is taken every 8.8 μsec which results in an overall sample rate of 113 kHz if there is no averaging. If there is averaging the effective sample rate is reduced by the number of samples in an average. For example, averaging 16 samples reduces the effective sample rate to 7.1 kHz. Parts running in continuous conversion mode will have I_{DD} equal to the I_{DD} during conversion listed above.

12. Use Cases for I²C Parts

12.1 Reading Magnetic Field Data by I²C

Starting from sleep with or without the sleep timer running, “wake” the part by I²C, as discussed in the data sheet. Prior to making a measurement adjust the sample size if desired (for higher resolution or less noise — `df_burstsize` of 0xCD). The measurement scale can be adjusted by changing `a0-a5` as described in Section 3 of the data sheet.

To do a single measurement, set the “one burst” bit of register 0xC4. When the sample is complete, read the data from 0xC1 and 0xC2, checking the fresh bit to make sure the conversion actually happened. All registers other than 0xC6 and 0xC7 are reloaded from OTP at each wake interval, so if sleep is used, then there is generally no reason to use these other registers. It is possible to get the temperature data associated with a conversion, as discussed in Section 5 of the data sheet.

12.2 Setting an Interrupt

For I²C programmable parts with the bit `Usestore` set, the fields `sw_op`, `sw_hyst`, `sw_low4field`, and `sw_fieldpolsel` are retained in sleep mode.

While it may be tempting to think of these parts as switch and latch parts with programmable switch and latch points, another way of looking at this is that an I²C part has an output pin which can act as an interrupt to a microprocessor and that the field level at which the interrupt will be generated is programmable.

For example, if a certain field is being measured and the output pin is low and the bit `sw_low4field` = 1, then the magnetic field is high indicating a door closed situation in a security system. Then, if the bit `sw_low4field` is reversed (set to 0), the output pin will go high. Now the output pin will go low when the field drops back low indicating a door open. Operating the part in this manner, inverting `sw_low4field`, would mean that a “low” will always indicate an event has happened (door open or door closed).

Once the event is sensed, then the Si7210 can be woken and the field can be measured. Based on the field measurement, the switch operating point (as determined by the field `sw_op`) can also be adjusted.

If the Si7210 is then put to sleep with the sleep timer enabled, it will autonomously wake and measure the field periodically at very low power and set the output pin in accordance with the field value and the fields `sw_op`, `sw_hyst`, `sw_low4field`, and `sw_fieldpolsel`. As the Si7210 can be very low power (0.4 μ A) in sleep mode sampling the magnetic field every 200 ms, this can enable very low system power with the microcontroller only waking for a change of state.

We normally set `sw_op` to 48 and `sw_hyst` to 18. This gives a nominal operate point of 0.64 mT and a nominal hysteresis of ± 0.2 mT so the nominal operate and release points would be 0.44 and 0.84 mT. Note that while the operate and release points can be adjusted, the tamper threshold will be reloaded from each wake and cannot be adjusted when the sleep timer is used.

For parts that have a sleep time programmed, the `sltimeena` bit is set by factory default so it does not have to be set.

To go to sleep making periodic measurements, set the `stop` bit of 0xC4 to zero. Do not set the `sleep` bit to 1 as the sleep and wake process is controlled by the sleep timer.

12.3 Complete Sleep

For complete sleep between measurements, set `sltimeena` = 0 prior to sleep and then set the `sleep` bit to 1. The part will go into the lowest power mode of 0.1 μ A but won't take measurements or provide an interrupt.

12.4 Idle Mode

After the I²C wake the part can be configured to make periodic measurements with idle between measurements rather than sleep between measurements. As the idle current is 360 μ A, this mode of operation is not generally used in low power applications. For this case, write `sltimeena` = 0 and then set `stop` = 0.

The time between measurements will now be controlled by register 0xC8. Other registers will have the same function as above. The registers will retain their values unless the part is put to sleep.

13. Code Examples

Following is the top level code showing how to wake, read data from the Si72xx, and go back to sleep.

```

#define OTP_BUSY_MASK          1
#define OTP_READ_EN_MASK      2
#define NUM_HALL_DEVICES      3
#define STOP_MASK             2
#define SLTIMEENA_MASK        1
#define SW_TAMPER_MASK        0xFC
#define SL_FAST_MASK          2
#define SLEEP_MASK            1
#define ONEBURST_MASK         4

/** I2C registers for Si72xx */
#define SI72XX_HREVID          0xC0
#define SI72XX_DSPSIGM         0xC1
#define SI72XX_DSPSIGL         0xC2
#define SI72XX_DSPSIGSEL       0xC3
#define SI72XX_POWER_CTRL      0xC4
#define SI72XX_ARAUTOINC       0xC5
#define SI72XX_CTRL1           0xC6
#define SI72XX_CTRL2           0xC7
#define SI72XX_SLTIME          0xC8
#define SI72XX_CTRL3           0xC9
#define SI72XX_A0              0xCA
#define SI72XX_A1              0xCB
#define SI72XX_A2              0xCC
#define SI72XX_CTRL4           0xCD
#define SI72XX_A3              0xCE
#define SI72XX_A4              0xCF
#define SI72XX_A5              0xD0
#define SI72XX_OTP_ADDR        0xE1
#define SI72XX_OTP_DATA        0xE2
#define SI72XX_OTP_CTRL        0xE3
#define SI72XX_TM_FG           0xE4

uint32_t Si72xx_ReadFieldValue(I2C_TypeDef *i2c, uint8_t i2cAddr, uint8_t range200mT)

int32_t Si72xx_ReadFieldValue(I2C_TypeDef *i2c, uint8_t i2cAddr, uint8_t range200mT)
{
    int32_t mT;
    uint8_t read;
    uint32_t result;
    uint8_t flag;
    //wake up the si7200
    result = Si72xx_WakeUp(i2c, addr);
    result |= Si72xx_Write_Register(i2c, addr, 0xC4, ONEBURST_MASK);
    if (range200mT)
    {
        result |= Si72xx_Set_200mT_Range(i2c, addr);
    }
    result |= Si72xx_Read_Data (i2c, addr, &data);
    if (range200mT)
    {
        mT = data * 125 / 10; //convert to mT*1000
    }
    else
    {
        mT = data * 125 / 100; //convert to mT*1000
    }
    //go back to sleep
    result |= Si72xx_Sleep (i2c, addr);

    return mT;
}

```

This function is an example of how to send the wakeup to the Si72xx on an EFM32 MCU. Only the address byte is sent.

```
uint32_t Si72xx_WakeUp(I2C_TypeDef *i2c, uint8_t i2cAddr)
{
    I2C_TransferSeq_TypeDef    seq;
    I2C_TransferReturn_TypeDef ret;
    uint8_t i2c_write_data[1];
    uint8_t i2c_read_data[1];

    seq.addr = i2cAddr;
    seq.flags = I2C_FLAG_WRITE;
    /* Select register and data to write */
    seq.buf[0].data = i2c_write_data;
    seq.buf[0].len = 0;
    seq.buf[1].data = i2c_read_data;
    seq.buf[1].len = 0;

    ret = I2CSPM_Transfer(i2c, &seq);
    if (ret != i2cTransferDone)
    {
        return (uint32_t)ret;
    }
    return (uint32_t)0;
}
```

This function is an example of how to write a Si72xx register using an EFM32 MCU.

```

/*****
 * @brief
 *   Writes register in the Si72xx sensor.
 * @param[in] i2c
 *   The I2C peripheral to use (not used).
 * @param[in] addr
 *   The I2C address of the sensor.
 * @param[in] data
 *   The data to write to the sensor.
 * @param[in] reg
 *   The register address to write to in the sensor.
 * @return
 *   Returns zero on success. Otherwise returns error codes based on the I2CDRV.
 *****/
uint32_t Si72xx_Write_Register(I2C_TypeDef *i2c, uint8_t addr, uint8_t reg, uint8_t data)
{
    I2C_TransferSeq_TypeDef    seq;
    I2C_TransferReturn_TypeDef ret;
    uint8_t i2c_write_data[2];
    uint8_t i2c_read_data[1];

    seq.addr = addr;
    seq.flags = I2C_FLAG_WRITE;
    /* Select register and data to write */
    i2c_write_data[0] = reg;
    i2c_write_data[1] = data;
    seq.buf[0].data = i2c_write_data;
    seq.buf[0].len = 2;
    seq.buf[1].data = i2c_read_data;
    seq.buf[1].len = 0;

    ret = I2CSPM_Transfer(i2c, &seq);
    if (ret != i2cTransferDone)
    {
        return (uint32_t)ret;
    }
    return (uint32_t)0;
}

```

This function is an example of how to read a Si72xx register using an EFM32 MCU.

```

/*****
 * @brief
 * Reads register from the Si72xx sensor.
 * @param[in] i2c
 * The I2C peripheral to use (not used).
 * @param[in] addr
 * The I2C address of the sensor.
 * @param[out] data
 * The data read from the sensor.
 * @param[in] reg
 * The register address to read from in the sensor.
 * @return
 * Returns number of bytes read on success. Otherwise returns error codes based on the I2CDRV.
 *****/
uint32_t Si72xx_Read_Register(I2C_TypeDef *i2c, uint8_t addr, uint8_t reg, uint8_t *data)
{
    I2C_TransferSeq_TypeDef seq;
    I2C_TransferReturn_TypeDef ret;
    uint8_t i2c_write_data[1];

    seq.addr = addr;
    seq.flags = I2C_FLAG_WRITE_READ;
    /* Select register to start reading from */
    i2c_write_data[0] = reg;
    seq.buf[0].data = i2c_write_data;
    seq.buf[0].len = 1;
    /* Select length of data to be read */
    seq.buf[1].data = data;
    seq.buf[1].len = 1;

    ret = I2CSPM_Transfer(i2c, &seq);
    if (ret != i2cTransferDone)
    {
        *data = 0xff;
        return (uint32_t)ret;
    }
    return (uint32_t)0;
}

```

To read the OTP the part must be awake first then:

```

uint32_t Si72xx_Read_OTP (I2C_TypeDef *i2c, uint8_t addr, uint8_t otpAddr, uint8_t *data)
{
    uint8_t read;
    uint32_t result;
    result = Si72xx_Read_Register(i2c, addr, SI72XX_OTP_CTRL, &read);
    if (read & OTP_BUSY_MASK)
    {
        return SI72XX_ERROR_BUSY;
    }
    result |= Si72xx_Write_Register(i2c, addr, SI72XX_OTP_ADDR, otpAddr);
    result |= Si72xx_Write_Register(i2c, addr, SI72XX_OTP_CTRL, OTP_READ_EN_MASK);
    result |= Si72xx_Read_Register(i2c, addr, SI72XX_OTP_DATA, &read);
    *data = read;
    return result;
}

```

To read the output data:

```
uint32_t Si72xx_Read_Data(I2C_TypeDef *i2c,uint8_t addr,int16_t *data)
{
    uint8_t read;
    uint8_t flag;
    uint32_t result;
    int32_t field;
    result = Si72xx_Read_Register(i2c,addr,SI72XX_DSPSIGM,&read);
    flag = read>>7;
    *data = (((uint16_t)read)&0x7f)<<8;
    result |= Si72xx_Read_Register(i2c,addr,SI72XX_DSPSIGL,&read);
    *data |= read;
    *data = *data - 16384;
    if (flag == 0)
    {
        result = SI72XX_ERROR_NODATA;
    }
    return result;
}

uint32_t Si72xx_Sleep (I2C_TypeDef *i2c,uint8_t addr)
{
    uint32_t result;
    uint8_t read;
    result = Si72xx_Read_Register(i2c,addr,SI72XX_POWER_CTRL,&read);
    read = read | 0x1;
    read = read & 0x81;
    result |= Si72xx_Write_Register(i2c,addr,SI72XX_POWER_CTRL,read);
    return result;
}

uint32_t Si72xx_Set_200mT_Range (I2C_TypeDef *i2c,uint8_t addr)
{
    uint8_t data;
    uint32_t result;
    uint8_t srcAddr = 0x27;
    result = Si72xx_Read_OTP(i2c,addr,srcAddr++,&data);
    result |= Si72xx_Write_Register(i2c,addr,SI72XX_A0,data);
    result |= Si72xx_Read_OTP(i2c,addr,srcAddr++,&data);
    result |= Si72xx_Write_Register(i2c,addr,SI72XX_A1,data);
    result |= Si72xx_Read_OTP(i2c,addr,srcAddr++,&data);
    result |= Si72xx_Write_Register(i2c,addr,SI72XX_A2,data);
    result |= Si72xx_Read_OTP(i2c,addr,srcAddr++,&data);
    result |= Si72xx_Write_Register(i2c,addr,SI72XX_A3,data);
    result |= Si72xx_Read_OTP(i2c,addr,srcAddr++,&data);
    result |= Si72xx_Write_Register(i2c,addr,SI72XX_A4,data);
    result |= Si72xx_Read_OTP(i2c,addr,srcAddr++,&data);
    result |= Si72xx_Write_Register(i2c,addr,SI72XX_A5,data);
    return result;
}
```

14. Choosing Operate and Release Points

The nominal operate point is the nominal decision point calculated from sw_op plus the nominal hysteresis calculated from sw_hyst and the nominal release point is the nominal decision point minus the nominal hysteresis.

Operate and release points must be chosen bearing in mind:

- Measurement noise
- Variation of offset over temperature
- Variation of gain over temperature
- Background fields

For a single sample, noise is approximately 30 μT at $V_{DD} = 5\text{ V}$. As V_{DD} reduces, noise increases so at the minimum V_{DD} of 1.71 V noise is typically 90 μT at room temperature.

For example in a door or window sensor in the open or zero field position, the effect of noise might be that the door or window is not detected as open on the first measurement at low V_{DD} or that with the door or window just “cracked” open readings might alternate between open and closed. These effects are probably tolerable. It probably would not be acceptable that for the door or window in the fully open position noise would result in an occasional door closed decision.

Offset is specified as $\pm 0.25\text{ mT}$ for $0\text{--}70\text{ }^\circ\text{C}$ and V_{DD} of 1.71 V to 3.6 V. These ranges are typical of security applications powered from a coin cell. Over the full temperature range of -40 to $+125\text{ }^\circ\text{C}$ and full V_{DD} range of 1.71 V to 5.5 V the offset can be $\pm 0.4\text{ mT}$. Gain accuracy is specified as $\pm 5\%$ $0\text{--}70\text{ }^\circ\text{C}$ and $\pm 8\%$ -40 to $+125\text{ }^\circ\text{C}$.

For a very sensitive part that operates over the limited temperature and V_{DD} range we choose nominal operate point sw_op to be decimal 48.

The below equation, converts to a nominal decision point of 0.64 mT.

$$\text{threshold} = (16 + swop[3:0]) \times 2^{swop[6:4]}$$

The hysteresis setting sw_hyst of 18 which gives $\pm 0.2\text{ mT}$ of hysteresis using so the nominal B_{OP} is 0.84 mT and the nominal B_{RP} is 0.44 mT.

$$\text{hysteresis} = (8 + swhyst[2:0]) \times 2^{sw_hyst[5:3]}$$

Applying the 5% gain accuracy and $\pm 0.25\text{ mT}$ offset gives:

$$B_{OP} \text{ maximum} = 0.84 \times 1.05 + 0.25 = 1.132\text{ mT}$$

$$B_{OP} \text{ minimum} = 0.84 \times 0.95 - 0.25 = 0.548\text{ mT}$$

$$B_{RP} \text{ maximum} = 0.44 \times 1.05 + 0.25 = 0.712\text{ mT}$$

$$B_{RP} \text{ minimum} = 0.44 \times 0.95 - 0.25 = 0.168\text{ mT}$$

Assuming a maximum background field of 0.1 mT (the earth's field is typically 0.05 mT) the minimum operate point is 0.448 mT greater than the background field which is five sigma away. This means there is a 2.78×10^{-6} chance that under worst case conditions of V_{DD} , temperature, maximum background field and worst offset that the sensor will report door closed when it is really open.

For an actual magnetic field of 1.1 gauss there is approximately a 50-50 chance the sensor will make the correct determination of door closed on the first reading under worst case conditions. After ten readings this would increase to 99.9% chance. For this reason we rate a sensor with this setting as a 1.1 mT sensitivity.

Once the determination of door closed is made the hysteresis will probably prevent the decision of door open. With the same 1.1 mT field the decision point is 0.388 mT over the maximum release point of 0.732 mT and there would be a 8.5×10^{-6} chance of a subsequent reading begin door open under worst case conditions.

When the field does return to zero the minimum release point of 0.168 mT is only 0.068 mT above the maximum background field and there is a 22% chance that the door would not be seen as closed on the first reading under these worst case conditions. After 10 readings the chance of not seeing door open reduces to 3.1×10^{-7} and once the open is reported it is again unlikely that a subsequent reading is door closed.

Without adding averaging so as to reduce the effect of noise (or using a well regulated 3.3 V supply to prevent the occurrence of the 1.71 V condition). These settings sw_op and sw_hyst and the most sensitive recommended. These settings are the default settings for all Si7210 switch type parts.

Another common setting for a less sensitive application is $sw_op = 64$ and $sw_hyst = 23$. This converts to a nominal decision point of 1.28 mT. sw_hyst of 23 gives ± 0.3 mT of hysteresis and nominal B_{OP} of 1.58 mT and B_{RP} of 0.98 mT. Over the full temperature and V_{DD} range this gives

$$B_{OP} \text{ maximum} = 1.58 \times 1.08 + 0.4 = 2.108 \text{ mT}$$

$$B_{OP} \text{ minimum} = 1.58 \times 0.92 - 0.4 = 1.054 \text{ mT}$$

$$B_{RP} \text{ maximum} = 0.98 \times 1.08 + 0.4 = 1.458 \text{ mT}$$

$$B_{RP} \text{ minimum} = 0.98 \times 0.92 - 0.4 = 0.502 \text{ mT}$$

We commonly refer to this as 2 mT operate and 0.6 mT release points because now the extremes of temperature and power supply are much less likely to occur and also because with the effects of noise the device will operate and release at these points.



Smart.
Connected.
Energy-Friendly.



Products
www.silabs.com/products



Quality
www.silabs.com/quality



Support and Community
community.silabs.com

Disclaimer
Silicon Labs intends to provide customers with the latest, accurate, and in-depth documentation of all peripherals and modules available for system and software implementers using or intending to use the Silicon Labs products. Characterization data, available modules and peripherals, memory sizes and memory addresses refer to each specific device, and "Typical" parameters provided can and do vary in different applications. Application examples described herein are for illustrative purposes only. Silicon Labs reserves the right to make changes without further notice and limitation to product information, specifications, and descriptions herein, and does not give warranties as to the accuracy or completeness of the included information. Silicon Labs shall have no liability for the consequences of use of the information supplied herein. This document does not imply or express copyright licenses granted hereunder to design or fabricate any integrated circuits. The products are not designed or authorized to be used within any Life Support System without the specific written consent of Silicon Labs. A "Life Support System" is any product or system intended to support or sustain life and/or health, which, if it fails, can be reasonably expected to result in significant personal injury or death. Silicon Labs products are not designed or authorized for military applications. Silicon Labs products shall under no circumstances be used in weapons of mass destruction including (but not limited to) nuclear, biological or chemical weapons, or missiles capable of delivering such weapons.

Trademark Information

Silicon Laboratories Inc.®, Silicon Laboratories®, Silicon Labs®, SiLabs® and the Silicon Labs logo®, Bluegiga®, Bluegiga Logo®, Clockbuilder®, CMEMS®, DSPLL®, EFM®, EFM32®, EFR, Ember®, Energy Micro, Energy Micro logo and combinations thereof, "the world's most energy friendly microcontrollers", Ember®, EZLink®, EZRadio®, EZRadioPRO®, Gecko®, ISOModem®, Precision32®, ProSLIC®, Simplicity Studio®, SiPHY®, Telegesis, the Telegesis Logo®, USBXpress® and others are trademarks or registered trademarks of Silicon Labs. ARM, CORTEX, Cortex-M3 and THUMB are trademarks or registered trademarks of ARM Holdings. Keil is a registered trademark of ARM Limited. All other products or brand names mentioned herein are trademarks of their respective holders.



Silicon Laboratories Inc.
400 West Cesar Chavez
Austin, TX 78701
USA

<http://www.silabs.com>