

IS-S04G1LC-S User Manual

Revision C

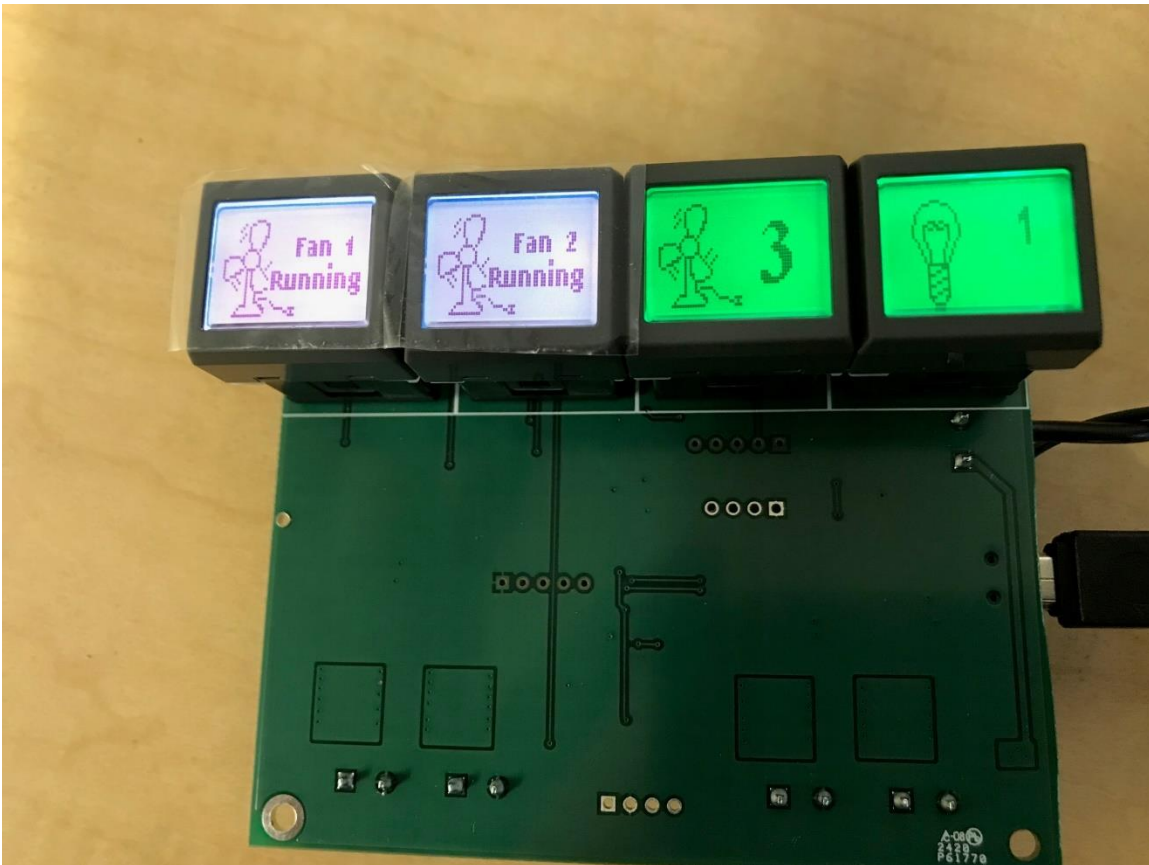

All Rights Reserved Worldwide

NKK Switches makes no warranty for the use of these products and assumes no responsibility for any errors, which may appear in this document, nor does it make a commitment to update the information contained herein. SmartDisplay is trademark of NKK Switches.

Table of Contents

1.LCD 64x32 SmartDisplay Switch	3
2.General IS-S04G1LC-S Features.....	4
3.Electrical Specifications.....	5
4.Images and Backlights	6
5.Operational Overview	8
6.Saving Images Using Engineering Kits Communicator	9
7.Board Connections.....	10
8.ASCII Hex	11
9.Key Terms & Definitions	12
10. Warranty	13

1. LCD 64x32 SmartDisplay Switch

The LCD 64x32 SmartDisplay switch is a graphic 64x32 pixels LCD display mounted in the key cap of a tactile momentary pushbutton. It has an RGB backlight with 64 color options and 8 brightness level.

The picture below is available backlight colors of LCD64x32. The top 2 digits on each color are the code for back light color.

03 00 00 00 Off	07 00 00 01 Midnight Blue	0B 00 00 10 Royal Blue	0F 00 00 11 Blue	43 01 00 00 Cherry	47 01 00 01 Fandango	4B 01 00 10 Purple	4F 01 00 11 Persian Purple	83 10 00 00 Brick	87 10 00 01 Rose	8B 10 00 10 Iris	8F 10 00 11 Red Violet	C3 11 00 00 Coral Red	C7 11 00 01 Carmine Pink	CB 11 00 10 French Rose	CF 11 00 11 Fuchsia
13 00 01 00 Astro Turf	17 00 01 01 Bluegrass	1B 00 01 10 Cerulean	1F 00 01 11 Electric Blue	53 01 01 00 Olive	57 01 01 01 Ashen	5B 01 01 10 Periwinkle	5F 01 01 11 Ceil	93 10 01 00 Gamboge	97 10 01 01 Salmon	9B 10 01 10 Puce	9F 10 01 11 Orchid	D3 11 01 00 Pumpkin	D7 11 01 01 Pink Orange	DB 11 01 10 Tea Rose	DF 11 01 11 Fuchsia Pink
23 00 10 00 Green	27 00 10 01 Jade	2B 00 10 10 Teal	2F 00 10 11 Sky Blue	63 01 10 00 Sap Green	67 01 10 01 Emerald	6B 01 10 10 Viridian	6F 01 10 11 Carolina Blue	A3 10 10 00 Citrine	A7 10 10 01 Maize	AB 10 10 10 Freezer Burn	AF 10 10 11 Thistle	E3 11 10 00 Golden Rod	E7 11 10 01 Amber	EB 11 10 10 Apricot	EF 11 10 11 Pink
33 00 11 00 Bright Green	37 00 11 01 India Green	3B 00 11 10 Pigment Green	3F 00 11 11 Juniper	73 01 11 00 Electric Lime	77 01 11 01 Light Lime	7B 01 11 10 Celery	7F 01 11 11 Turquoise	B3 10 11 00 Yellow Green	B7 10 11 01 June Bug	BB 10 11 10 Moss Green	BF 10 11 11 Baby Blue	F3 11 11 00 Canary Yellow	F7 11 11 01 Yellow	FB 11 11 10 Eggshell	FF 11 11 11 White

Backlight Color Code Table

SmartDisplay is ideal for use in applications with multiple, complex functions which would ordinarily require many dedicated switches and complex training. The dynamic nature of the system allows for instantaneous transitions from generalized lists of categories down to function specific actions. This reduces the need for complicated controls and shortens the time for training by only displaying relevant options and commands.

Backlight colors can be used to easily recognizable functions scheme.

NKK can supply subsystems with any number and configuration of LCD 64x32 switches. The subsystem can have communications such as USB, Ethernet, CAN, RS232, RS485 etc. The subsystem additionally can sense/control various status, gauges, and devices.

To help with development, NKK offer engineering kits with schematic and source code for all the SmartDisplay's. A free software, Engineering Kits Communicator, is available to test and download images for communication to various controllers. Also, NKK Switches provides all the documentation necessary to get up and running quickly on our website: <https://www.nkkswitches.com/SmartDisplay-resources/>

Please contact engineering@nkkswitches.com with your requirements or any question.

2. General IS-S04G1LC-S Features

The IS-S04G1LC-S has four LCD64x32 switches that control four 12V lights or Fans. It has USB communication for downloading images and set up. The current firmware is written for stand alone operation. However, it is possible to modify the firmware to function under partial/complete control of USB. For any changes to the firmware please contact engineering@nkswitches.com. Below are the stand alone features.

Features:

- 4 LCD64x32 control 4 lights/fans
- User defined images for ON/OFF
- User defined Backlight colors
- Pressing any of the switches toggle between ON/OFF corresponding control
- Eight level PWM control for each light or fan
- Holding any of the switches down for about 2.5 second allow for changing the PWM level
- Pressing the switch one and four at the same time allow changing the backlight intensity
- The setting of PWM levels and backlight intensity are saved
- Power Specs: 12V and maximum of 300 mA (does not include power for lighting or fan)
- USB for downloading images and backlights
- Firmware is written for stand alone operation. It can be changed to be under control of host.
- On-board temperature sensor
- Windows based Engineering Kits communicator software is available for communication.
 - Accepts bitmap files, extracts the images and download them to the controller.
 - Allows typing of commands and downloading to the controller.
 - Messages to and from the controller are displayed in different colors.

3. Electrical Specifications

This product is ESD sensitive and should be handled according to ESD procedure.

- Input Voltage: 7V to 12V. Higher voltage of up to 30V maybe possible by adding a heatsink to the voltage regulator.
- Current: 100 mA to 250 mA. Depends on Backlight brightness and colors. Does not include lights/fans current consumption
- PWM period: 459 microseconds
- PWM duties

Level	Duty cycle
1	1/36
2	2/36
3	3/36
4	8/36
5	18/36
6	23/36
7	28/36
8	36/36

- Operating Temperature -10 to +50 Degree C. Backlight brightness level must be less than level 7 for ambient temperature above 35 degree C
- Storage Temperature -20 to +60 Degree C
- Temperature Sensor Accuracy +/- 2 Degree C. Please note the temperature sensed is a few degrees above ambient due to the PCB temperature effect.

4. Images and Backlights

Images can be created in any graphics software such as Paint, Photoshop, etc., or even user-created software. All images can be saved onto the system by using the free Engineering Kits Communicator, located on the NKK Website:

<https://www.nkkswitches.com/>

(Images can also be loaded onto the system with user-created software as long as the rules for the images and communications are followed.)

To use Engineering Kits communicator, images must be saved in the proper format:

LCD 64x32	Monochrome bitmap (.bmp) 64x24 pixels
-----------	---------------------------------------











There are 11 images associated with the light/fan control system. (next page)

The Backlights can be modified by changing the LED codes in the Excel file and downloading the Excel file using Engineering kits Communicator. The LED codes are stated in the backlight color code table.

The last column is the temperature in degree C. Once the temperature gets above input temperature all 4 fans turn ON.

; command	For Switch #1 ON	For Switch #2 ON	For Switch #3 ON	For Switch #4 ON	For Switch #1 OFF	For Switch #2 OFF	For Switch #3 OFF	For Switch #4 OFF	for Adjusting PWM levels	for Adjusting BACKLIGHT levels	TEMP Turn FANs ON
*R000055	FF	FF	FF	FF	33	33	33	33	CF	3F	32

Factory Default Images and Backlights

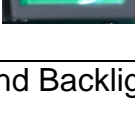
Address	Image function	Factory default	Backlight
0001	Light/FAN 1 ON		FF white
0002	Light/FAN 2 ON		FF white
0003	Light/FAN 3 ON		FF white
0004	Light/FAN 4 ON		FF white
0005	Light/FAN 1 OFF		33 Green
0006	Light/FAN 2 OFF		33 Green
0007	Light/FAN 3 OFF		33 Green
0008	Light/FAN 4 OFF		33 Green
0009	PWM Level Adjustment		F3 Magenta
000A	LCD Backlight Adjustment		3F Light blue
000B	Temperature Display		

The factory default level of all PWM is 1 and Backlight brightness is 4.

5. Operational Overview

Upon power-up the system start with all four lights/fans control in OFF state. Pressing any switch turn ON the associated light/fan, pressing it again will turn OFF the associated light/fan. The changes happen on the switch releases.

Press and hold any of the switches to change the brightness/speed of the associated light/fan. After 2.5 seconds the image of address 09 and the level will be displayed on the switch. Releasing and pressing the switch will cycle through the 8 levels. When the switch is released for 4.5 seconds, the selected level is saved, and the switch display the ON image.

Press switch #1 and #4 at the same time, switch #1 display image of address 10 and the backlight brightness level. Releasing and pressing the switch #1 will cycle through the 8 brightness levels. When the switch is released for 4.5 seconds, the selected brightness level is saved and the switch #1 display the status image of before the adjustment.

Press switch #2 and #3 at the same time, switch #4 display image of address 11 and the temperature in degree Centigrade and Fahrenheit. The Switch #4 continue to display while a switch is depressed. Once all the switches are released, the switch #4 display the status image of before the adjustment.

Any changes to brightness/speed and backlight brightness levels are saved and stay in affect till change again.

When there is no switch activity for 20 seconds, the backlights will be turned OFF. While the backlights are OFF pressing any switch cause the backlight to turn ON. The press to turn ON the backlight do not affect the operation.

6. Saving Images Using Engineering Kits Communicator

The Engineering Kits Communicator loads the images in alphanumeric order according to the image files names. It auto-assigns a sequential address to each image. Be sure to keep this in mind when naming images so that images are listed in the desired order. Avoid using symbols in the names as some symbols interfere with alphanumeric ordering. All images to be loaded should be saved in a single folder. The default starting address is 0001. This can be changed if needed.

To save images to the system:

1. Open the Engineering Kits Communicator.
2. From the drop-down menu at the top, select the COM port of the system (usually the last one).
3. Click the 'Open Port' button.
4. Press the call button and verify the system responds with '61' in blue text in the left text box.
5. Select the image type "64x32 Mono" from the drop-down in the 'Loading Images' section.
6. Click the 'Import Images' button.
7. Navigate to the directory with all the images and select one and click 'Open'.
8. Note that the images are loaded alphanumerically and automatically assigned addresses.
 - a. If some/all images do not show up in the image list after selecting the directory, it is because the image is not in the proper resolution or file type (.bmp). Double-check the image size is correct *before* downloading. If an image was skipped the images will load one address off.
9. Click the 'All selected images' button at the bottom.
10. Wait for the 'Success' message. If the process fails, click the 'All selected images' button again.

7. Board Connections

Dimension: 3.2"x 3.67"

Cutout: PDF file

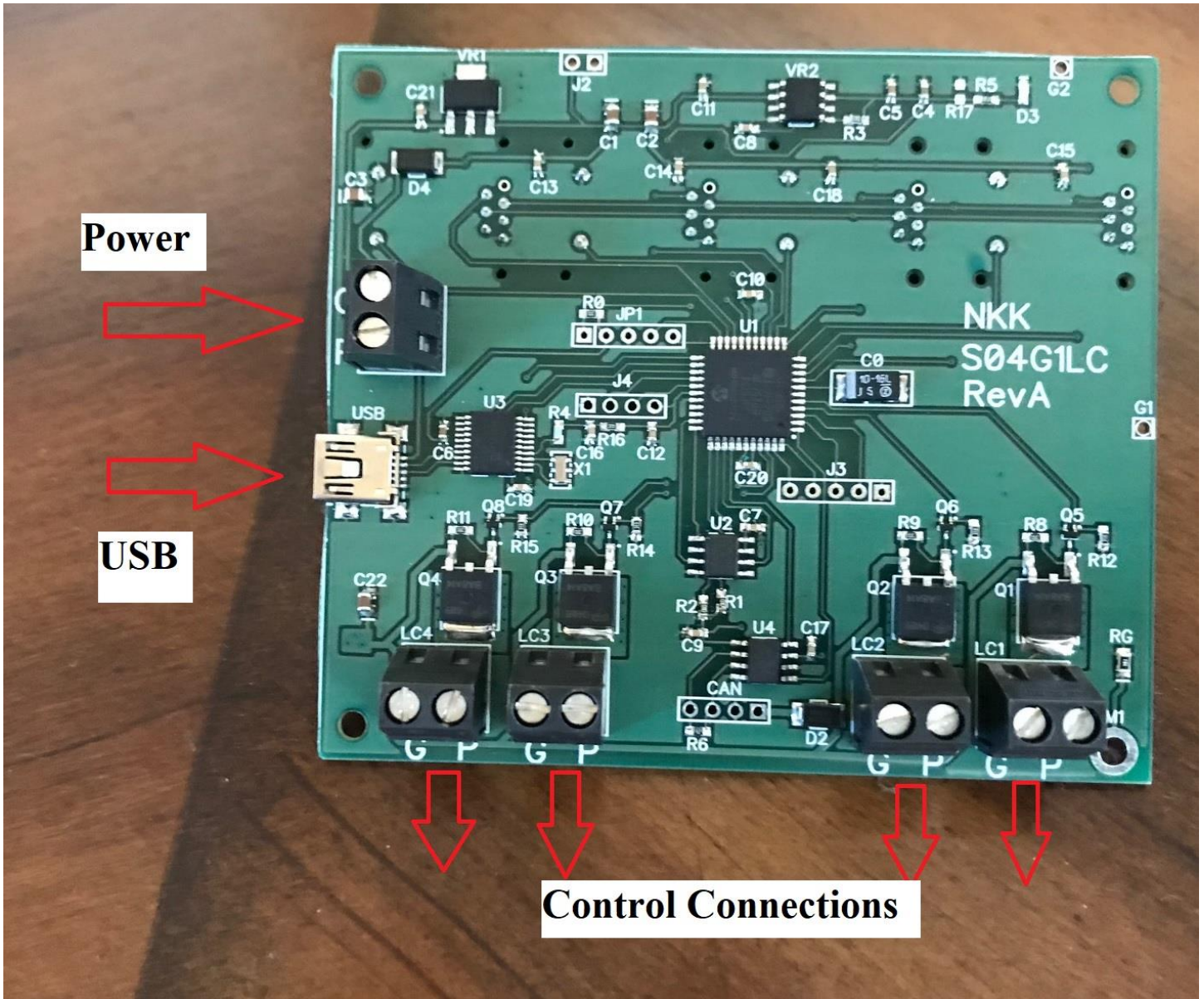

8. ASCII Hex

All USB data is sent as ASCII hex as a safety measure to avoid being interpreted as a command. ASCII hex is a normal data byte split into two halves and converted to their ASCII equivalent (see www.asciitable.com). Therefore, all data received will be in the 0x30-0x46 number range, and anything received outside that is invalid. For example:

Data to be sent is 0x3D.

Each nibble is assigned its own byte: 0x3 and 0xD.

Each of those bytes is converted to ASCII equivalent: 0x33 0x44 (0x33 is the ASCII number '3'. 0x44 is the ASCII letter 'D').

Receiving is the same process reversed:

Data received is 0x41 0x37.

Each byte converted from the ASCII equivalent is 0xA 0x7 (0x41 is the ASCII letter 'A', 0x37 is the ASCII number '7').

Combine the two bytes to get the data byte 0xA7.

9. Key Terms & Definitions

Host	Any computer, terminal, or other device that can communicate over the USB line.
Byte	An eight-bit hex value ranging from 00H to FFH (Decimal 0 to 255). The bit format of a byte is: (B7 B6 B5 B4 B3 B2 B1 B0) where B7 is most significant and bit B0 is least significant bit.
Nibble/Hex Digit	A four-bit value ranging from 0H to FH. A byte consists of two nibbles.
ASCII	A byte value representing a symbol.
Communication Format	<p>There are two formats to transmit a byte:</p> <ol style="list-style-type: none">1. Hex format - A hex byte is transmitted without any change to it. [xxH] will be used to denote this. All commands and some data are sent by using this format.2. ASCII HEX format - Each nibble of the byte is converted to ASCII code and sent as a byte. [xxAH] will be used to denote this. For example, the hex byte 5AH is transmitted in two bytes, 35H and 41H. The ASCII value for 5 is 35H and the ASCII value for A is 41H. All addresses and most data are sent using this format.
Address	A two-byte value ranging from 0001H to 000AH representing the 10 memory locations for images on the flash memory.

10. Warranty

NKK SWITCHES LIMITED WARRANTY AND LIMITATION OF LIABILITY

The following limits our liability. Please read.

NKK Switches hereby warrants this product against any and all manufacturing defects for a period of one year from the date of sale of this product to the original end user. NKK Switches' liability in the event of such defect is limited to repair or replacement of the defective products. NKK Switches disclaims any liability or warranty obligation with respect to any product that is misused, damaged by any user, or not used in conformity with all applicable product specifications.

NKK SWITCHES HEREBY DISCLAIMS ANY WARRANTY, EXPRESS OR IMPLIED, OTHER THAN THAT CONTAINED HEREIN. **NKK SWITCHES EXPRESSLY DISCLAIMS THE WARRANTIES OF MERCHANTABILITY AND FITNESS FOR A PARTICULAR PURPOSE, AND SHALL HAVE NO LIABILITY BASED ON OR ARISING FROM ANY CLAIM OF SUCH WARRANTY.**

NKK Switches shall have no liability to any person for any incidental, consequential, special, punitive, or other damages of any kind whatsoever relating to any use of this product.

USE OF THIS PRODUCT IN CONNECTION WITH ANY LIFE CRITICAL APPLICATION IS NOT RECOMMENDED.