

CPFE1000Fi-28

EVALUATION DATA

Tested By: Miguel Valdez / <i>M. Valdez</i>	Date : 11/11/2015
---	-------------------

Name/Signature

Checked By: Kenneth Rose / <i>KC Rose</i>	Date : 11/11/2015
---	-------------------

Name/Signature

Approved By: Greg Laufman / <i>Greg Laufman</i>	Date: 11/12/2015
---	------------------

Name/Signature

INDEX

1. Test Set-ups

2. Characteristics

- 2.1 Line and Load regulation
- 2.2 Input turn ON/OFF voltage characteristics.
- 2.3 Efficiency and Power factor vs. Output power and Input Voltage, Standby Input Power
- 2.4 Over current protection (OCP) characteristics.
- 2.5 Over voltage protection (OVP) characteristics.
- 2.6 Output rise and fall characteristics
- 2.7 Output rise and fall characteristics with ON/OFF control.
- 2.8 Hold up time characteristics
- 2.9 Dynamic line response characteristics
- 2.10 Dynamic load response characteristics
- 2.11 Response to brownout characteristics
- 2.12 Inrush current characteristics
- 2.13 Input current waveforms
- 2.14 Input current harmonics
- 2.15 Leakage current characteristics
- 2.16 Output ripple and noise waveforms

Test Equipment used:

Digital Multi-Meter (DMM) - Model: Fluke 45
Power Source - Model: Kikusui DCR4000L
Electronic Load - Model: Chroma 63201
Digital Power Meter - Model: Yokogawa WT2010
Digital Power Meter - Model: Chroma 66202
Oscilloscope - Model: Tektronix DPO2024
Leakage Tester - Associate Research Model no. 620L

Terminology used

Vin	Input Voltage	Io.....	Output Current
Vout.....	Output Voltage	Tbp.....	Base Plate Temperature
Vctrl.....	Control Voltage	Ta.....	Ambient Temperature
Iin.....	Input Current	f.....	Frequency
Pin.....	Input Power	Eff.....	Efficiency
Po.....	Ouptut Power	PF.....	Power factor

1. Test set-ups

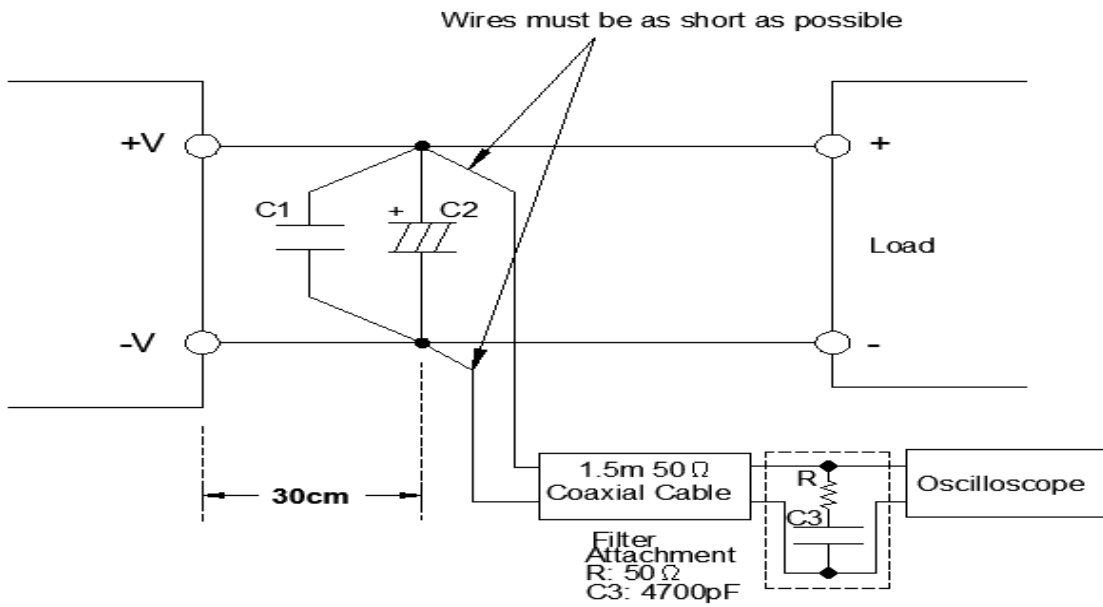
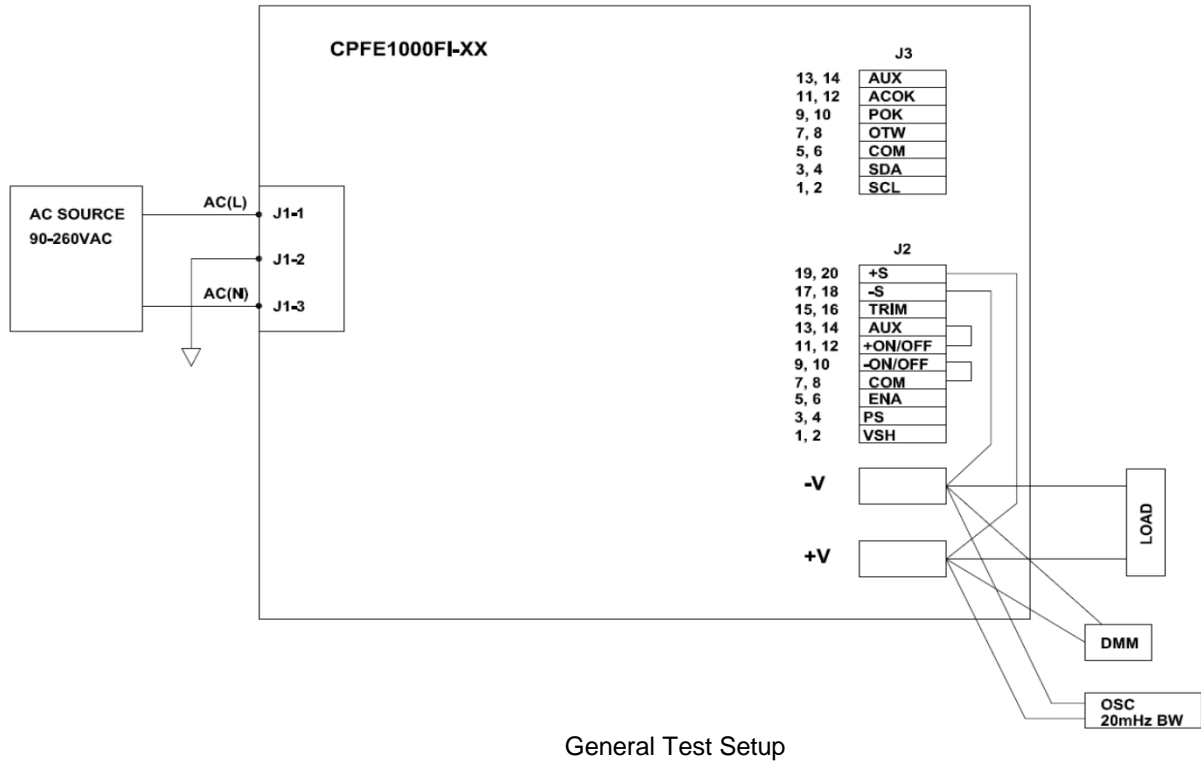

C1 - 0.1 μ F Ceramic Capacitor

C2 - 47 μ F Aluminum Electrolytic Capacitor

Setup for Ripple Measurement

2. Characteristics

2.1 Line and Load Regulation:

Condition Tbp = 25°C

Vout measured across output studs using **local sense** connections.

Io \ Vin	90 VAC	110 VAC	220 VAC	265 VAC	Line Regulation	
0% Load	28.054	28.055	28.056	28.058	0.004	0.008%
25% Load	28.047	28.047	28.046	28.046	0.001	0.002%
50% Load	28.040	28.040	28.039	28.039	0.001	0.002%
75% Load	28.034	28.035	28.037	28.038	0.004	0.008%
100% Load	28.042	28.039	28.036	28.034	0.008	0.017%
Load Regulation	0.02	0.02	0.02	0.024		
	0.042%	0.042%	0.042%	0.050%		

Vout measured across output studs using **remote sense** connections.

Io \ Vin	90 VAC	110 VAC	220 VAC	265 VAC	Line Regulation	
0% Load	27.994	27.993	27.992	27.990	0.004	0.008%
25% Load	28.019	28.019	28.020	28.021	0.002	0.004%
50% Load	28.051	28.051	28.051	28.051	0	0.000%
75% Load	28.087	28.086	28.086	28.085	0.002	0.004%
100% Load	28.123	28.124	28.126	28.128	0.005	0.010%
Load Regulation	0.129	0.131	0.134	0.138		
	0.269%	0.273%	0.279%	0.288%		

2.2 Input turn ON/OFF voltage characteristics.

Condition Tbp = 25°C

	0% Load	100%Load
Turn ON Voltage	77	75
Turn OFF Voltage	69	70

2.3 Efficiency and Power factor vs. Output power and Input Voltage, Standby Input Power

Condition Tbp = 25°C

Vin	Iin	Pin	PF	Vout	Io	Po	Eff	Load
90 VAC	0.632	48.7	0.85	28.049	0.0	0	N/A	0%
110 VAC	0.528	47.7	0.801	28.073	0.0	0	N/A	
220 VAC	0.49	45.7	0.423	28.065	0.0	0	N/A	
265 VAC	0.654	44.7	0.258	28.071	0.0	0	N/A	
90 VAC	3.366	329.7	0.95	28.044	9.0	252.396	76.55%	25%
110 VAC	3.148	327.3	0.933	28.073	9.0	252.657	77.20%	
220 VAC	1.616	312.4	0.878	28.051	9.0	252.459	80.81%	
265 VAC	1.459	308.6	0.801	28.07	9.0	252.63	81.86%	
90 VAC	7.141	611.6	0.950	28.037	18.0	504.666	82.52%	50%
110 VAC	5.766	609.5	0.952	28.069	18.0	505.242	82.89%	
220 VAC	2.857	584.5	0.930	28.043	18.0	504.774	86.36%	
265 VAC	2.490	577.7	0.878	28.066	18.0	505.188	87.45%	
90 VAC	10.510	904.9	0.957	28.036	27.0	756.972	83.65%	75%
110 VAC	8.498	899.9	0.956	28.063	27.0	757.701	84.20%	
220 VAC	4.160	865.9	0.948	28.038	27.0	757.026	87.43%	
265 VAC	3.562	855.7	0.910	28.060	27.0	757.62	88.54%	
90 VAC	14.060	1218.6	0.968	28.038	36.0	1009.368	82.83%	100%
110 VAC	11.338	1204.3	0.961	28.057	36.0	1010.052	83.87%	
220 VAC	5.514	1157.0	0.956	28.040	36.0	1009.44	87.25%	
265 VAC	4.660	1143.7	0.931	28.049	36.0	1009.764	88.29%	

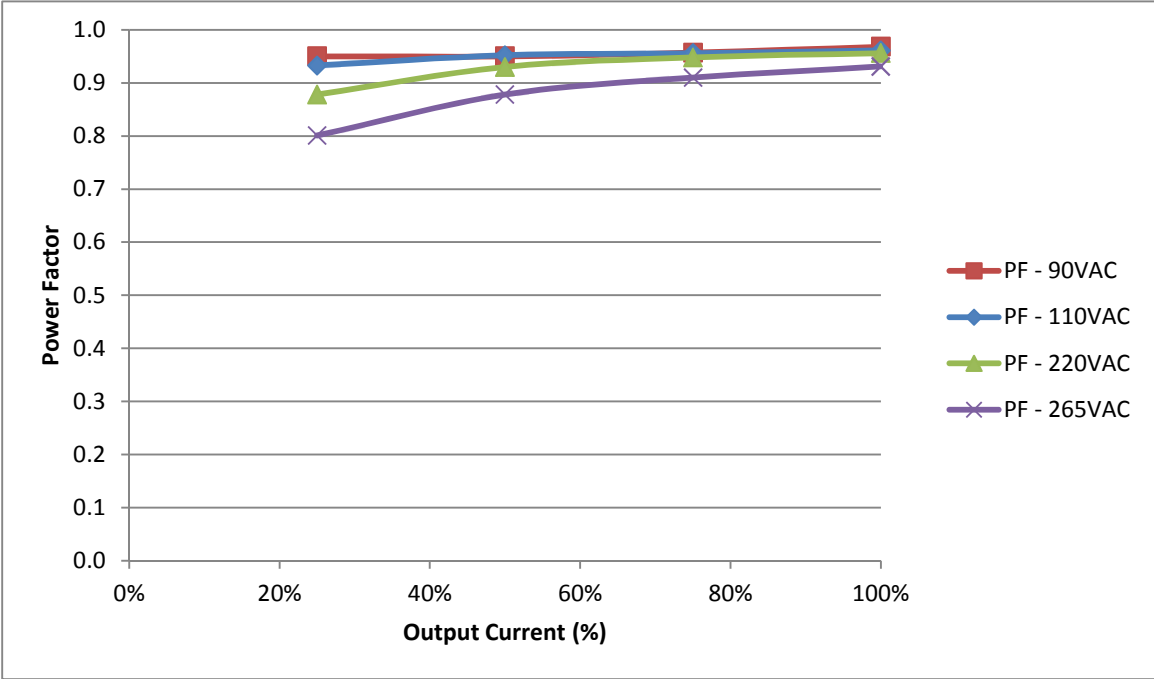
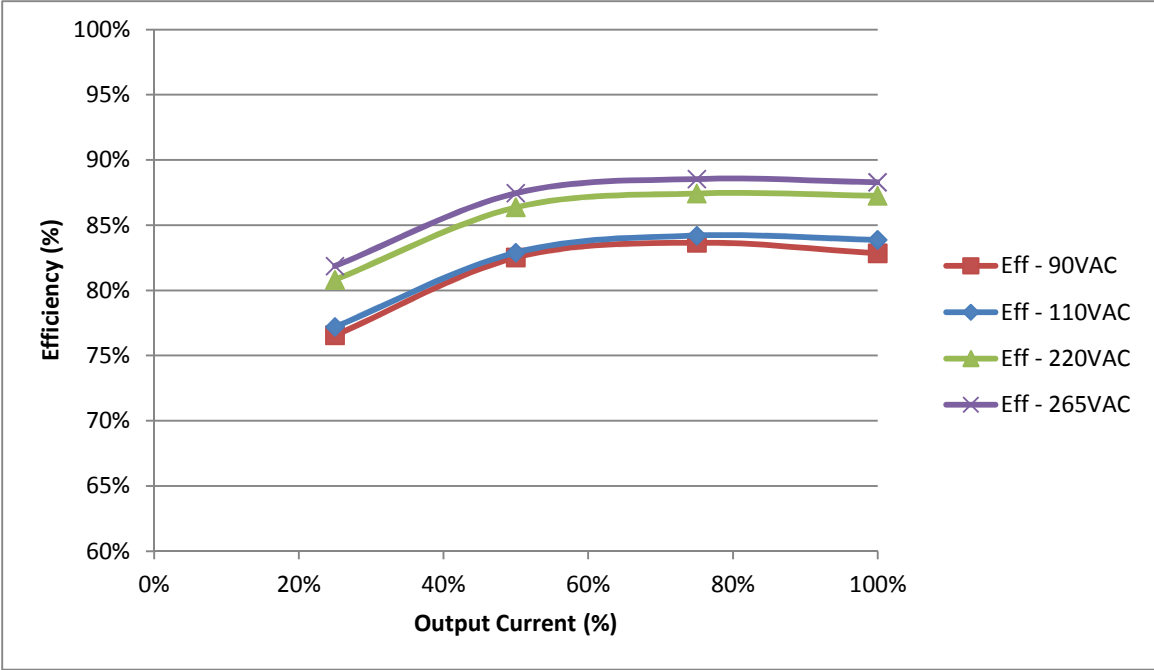

2.4 Over current protection (OCP) characteristics.

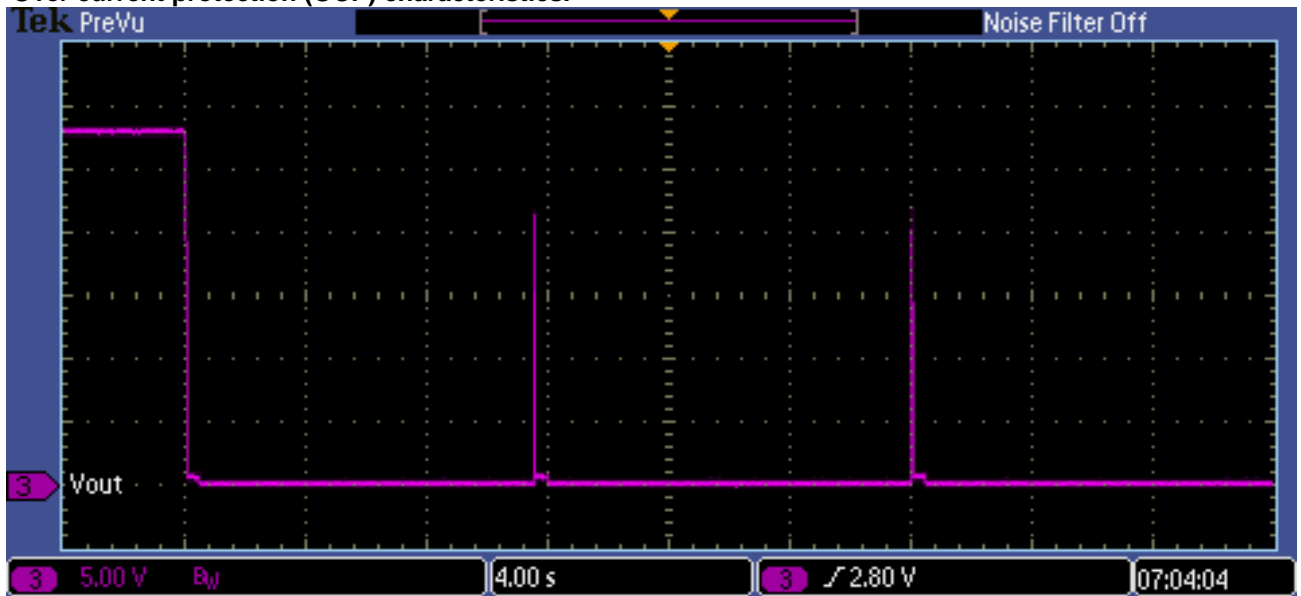

Vout: 5V/div
4s/div
Output Voltage during OCP mode.

2.5 Over voltage protection (OVP) characteristics.

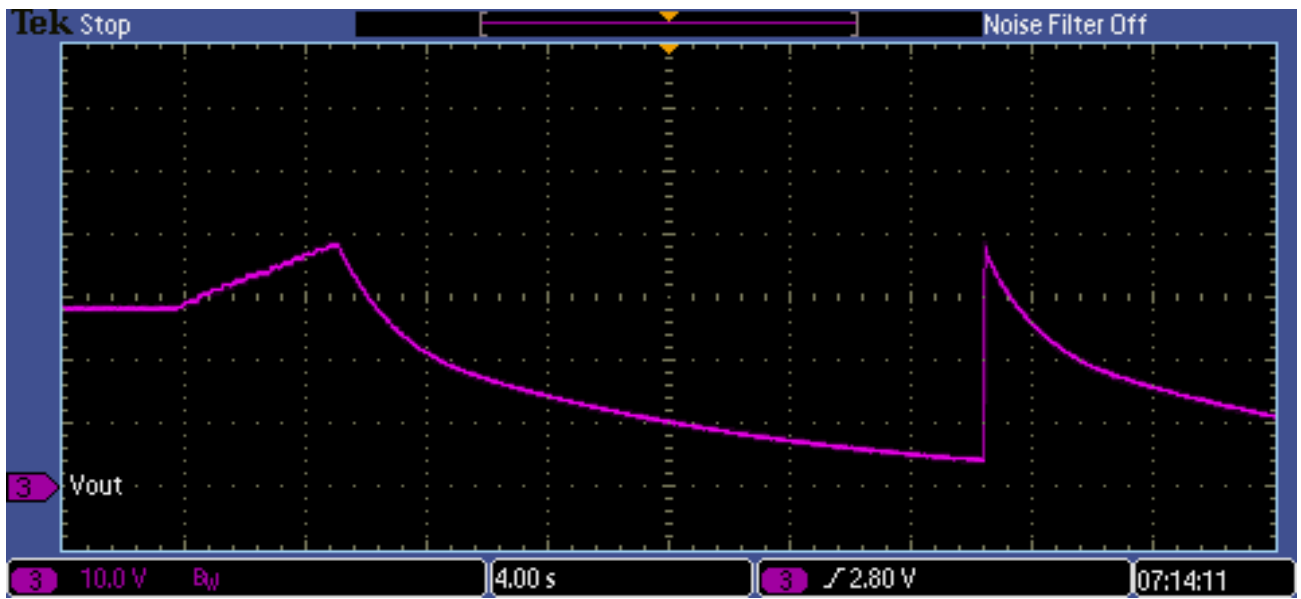

Output Voltage during OVP mode (0% Load)

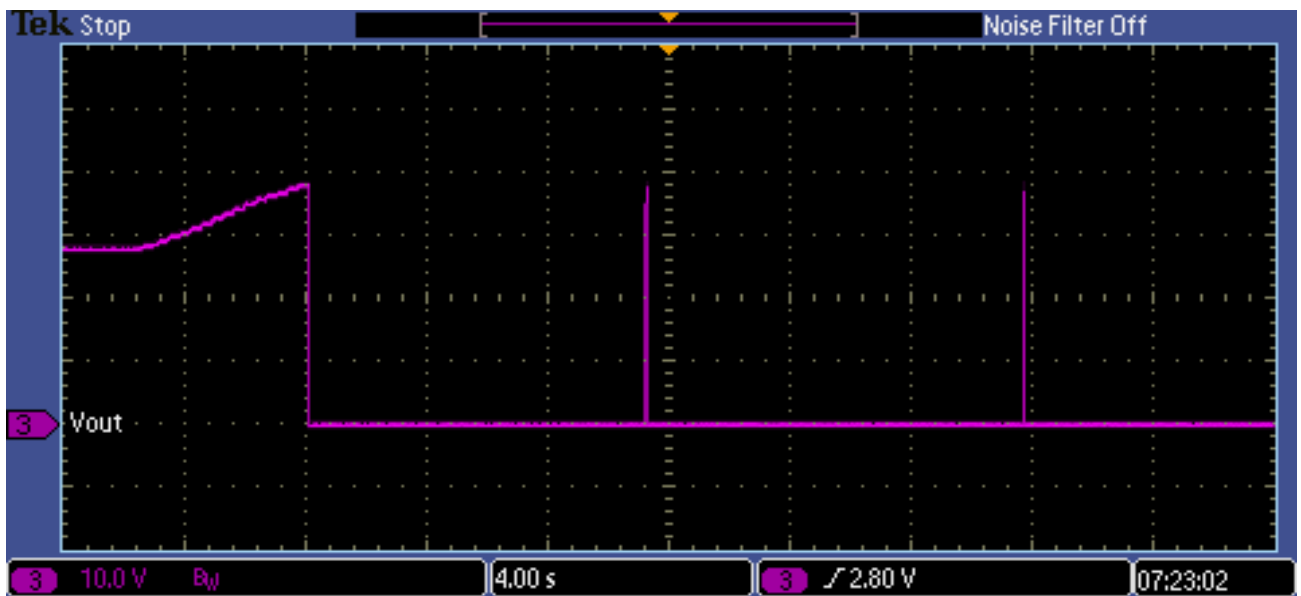

Output Voltage during OVP mode (100% Load)

2.6 Output rise and fall characteristics

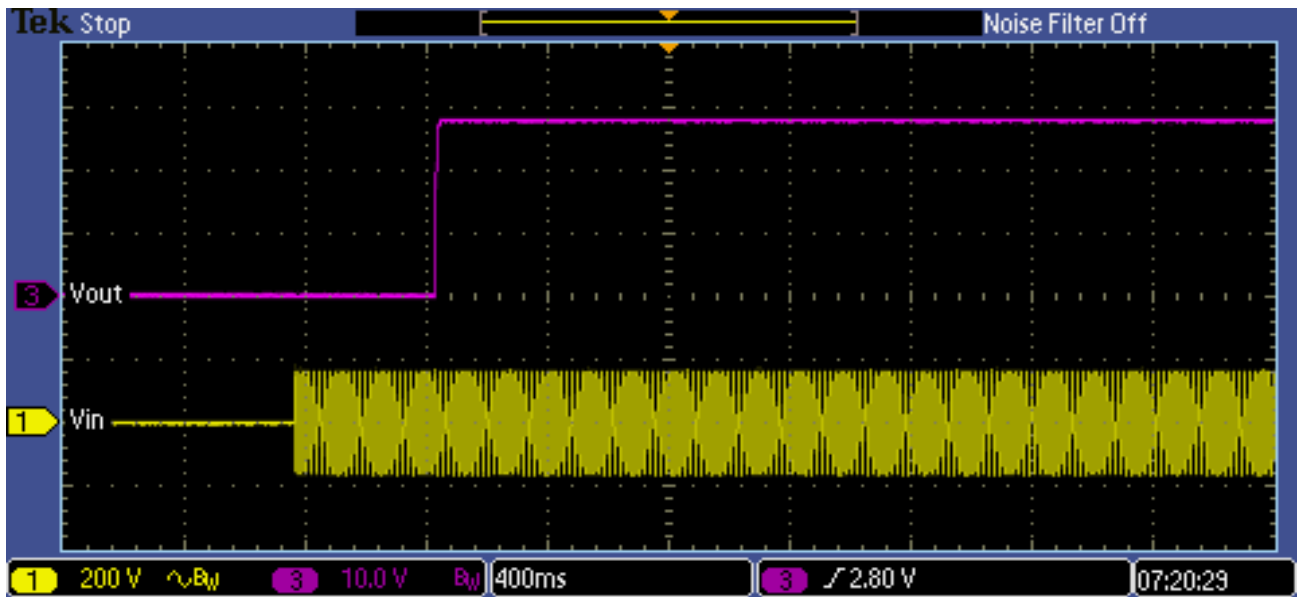

Vin: 200V/div Vout: 10V/div 400ms/div
Output rise (0% Load, 110Vac input)

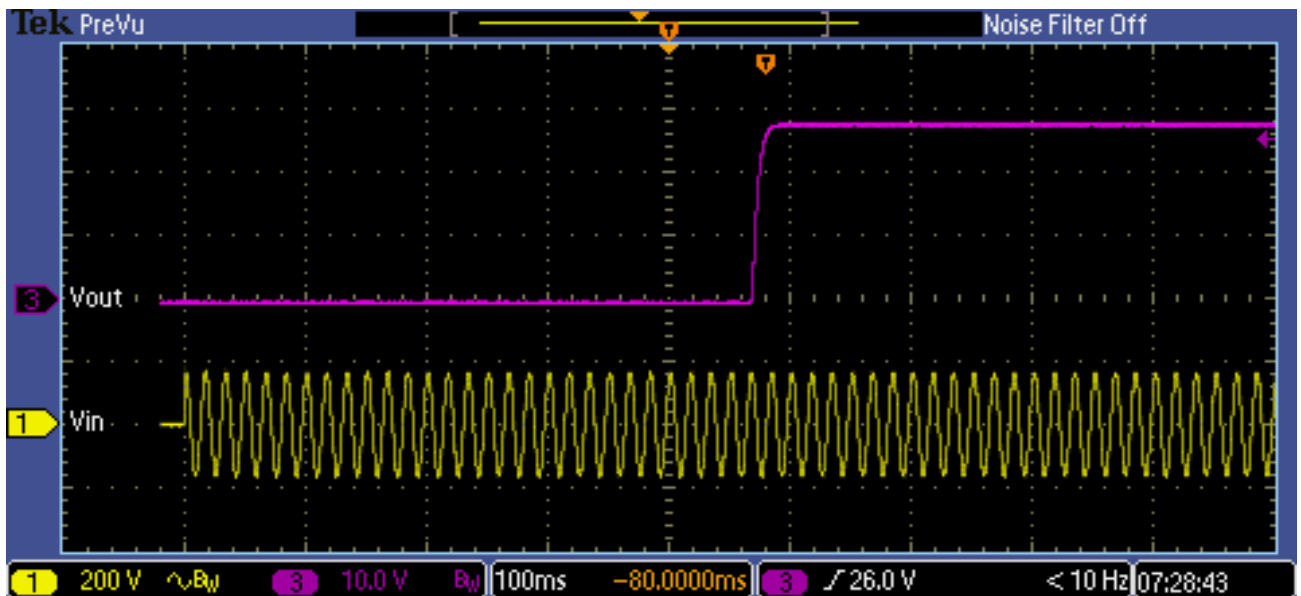

Vin: 200V/div Vout: 10V/div 100ms/div
Output rise (100% Load, 110Vac input)

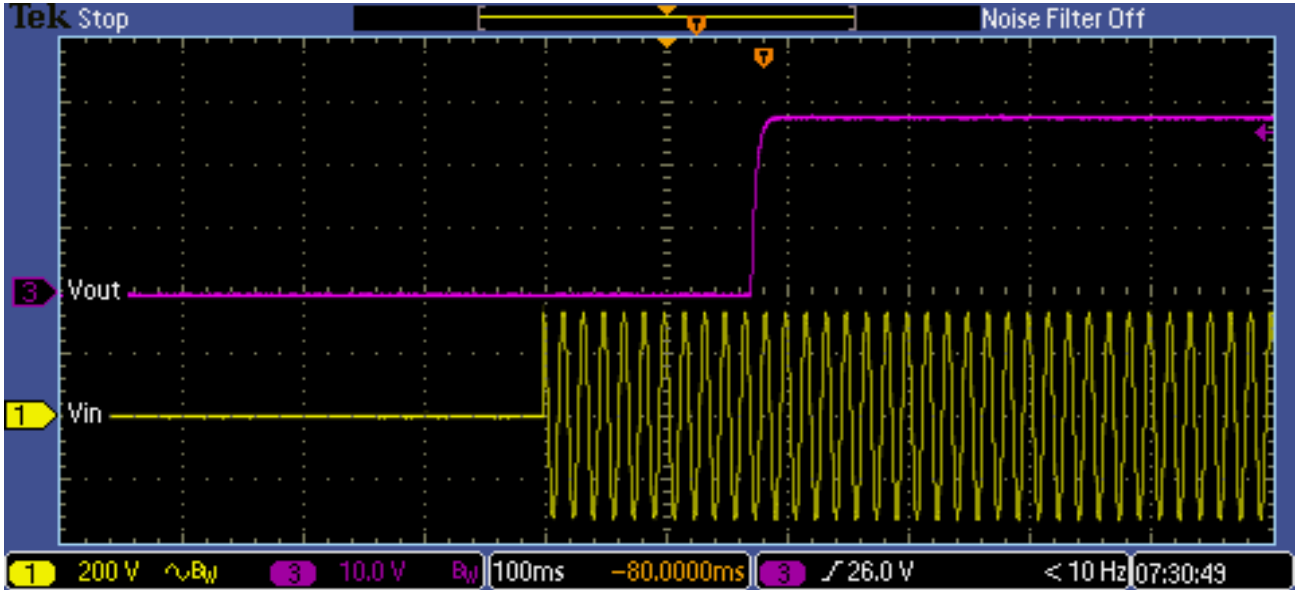

Vin: 200V/div Vout: 10V/div 100ms/div
Output rise (0% Load, 220Vac input)

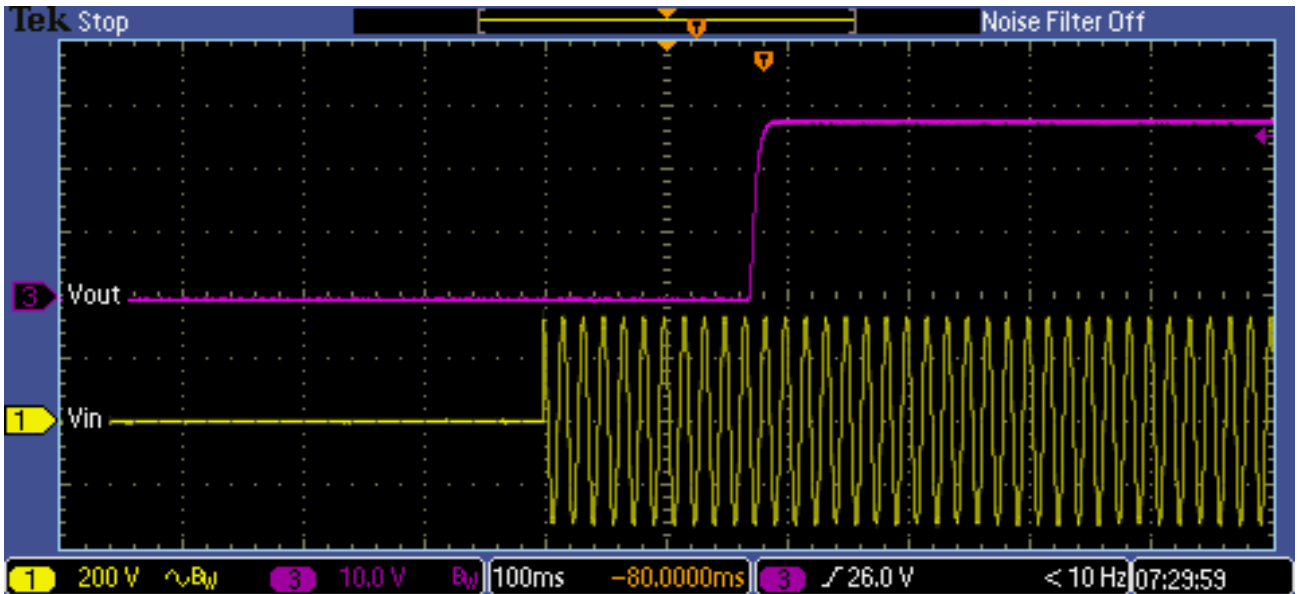

Vin: 200V/div Vout: 10V/div 100ms/div
Output rise (100% Load, 220Vac input)

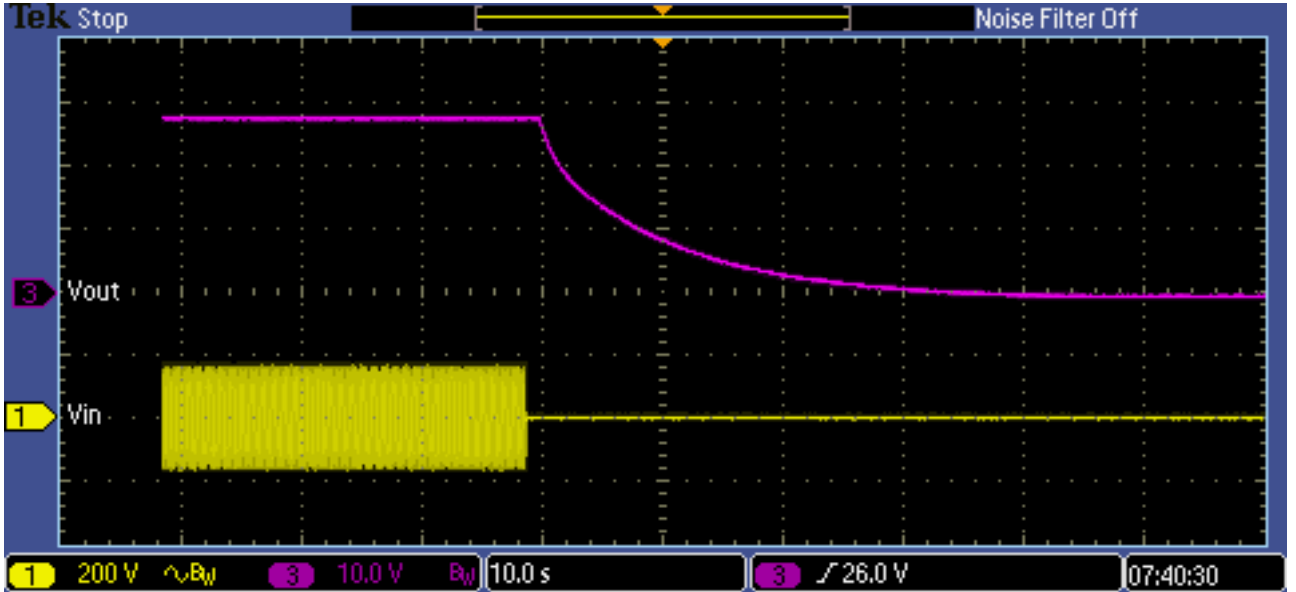

Vin: 200V/div Vout: 10V/div 10s/div
Output fall (0% Load, 110Vac input)

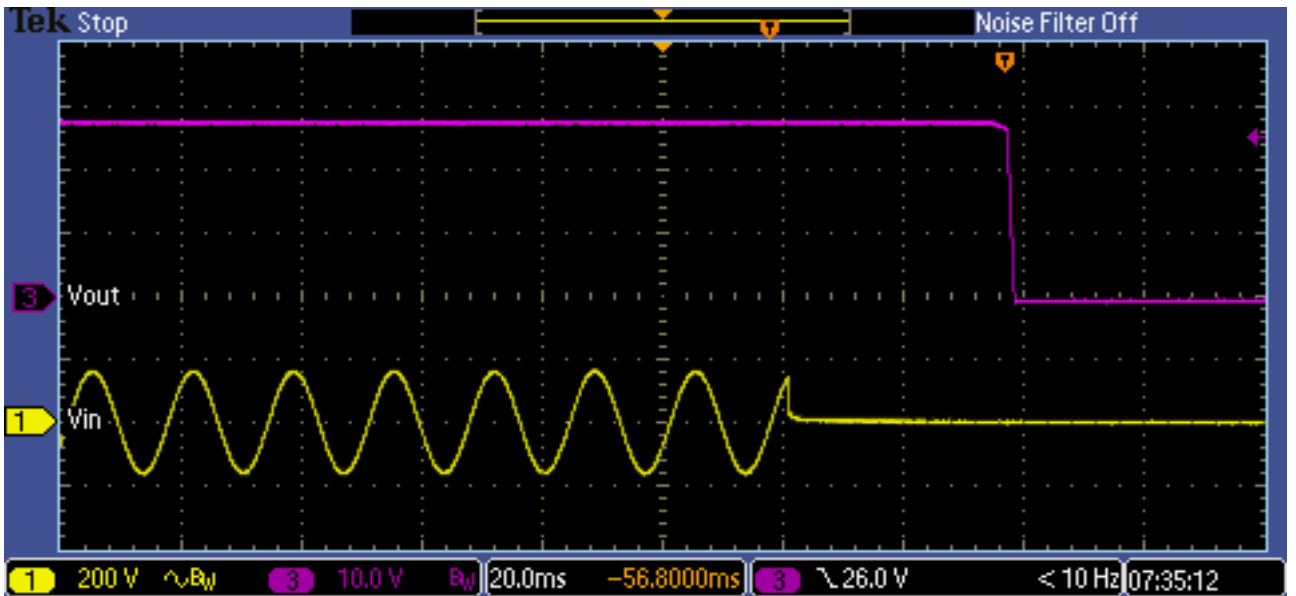

Vin: 100V/div Vout: 10V/div 20ms/div
Output fall (100% Load, 110Vac input)

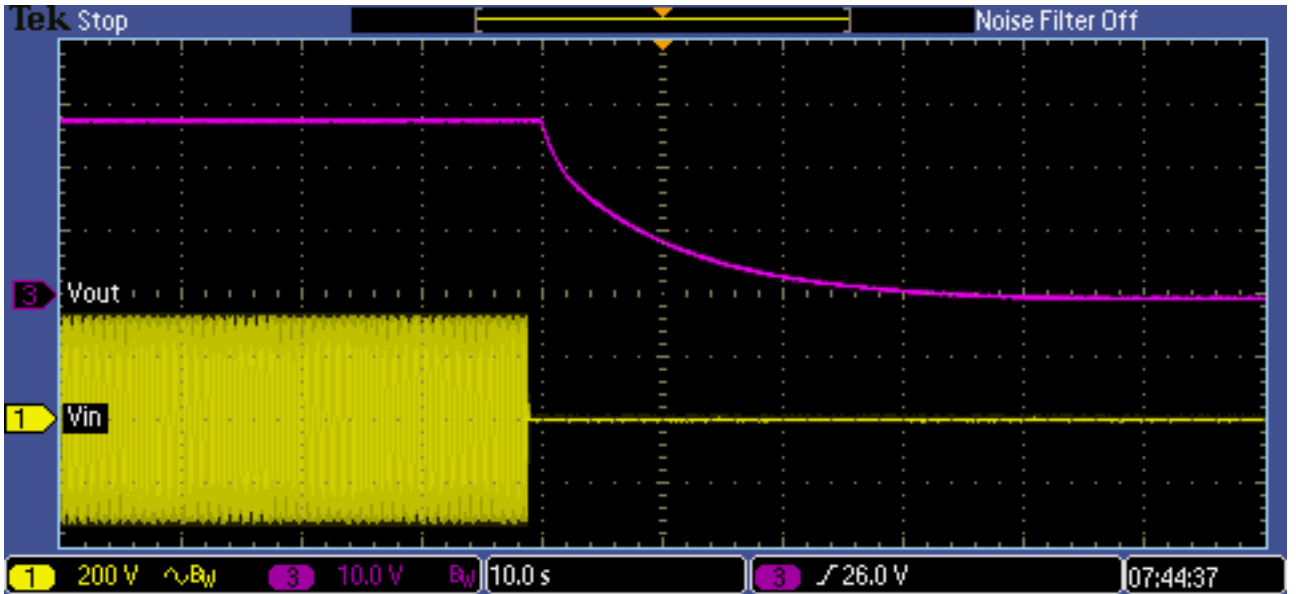

Vin: 200V/div Vout: 10V/div 10s/div
 Output fall (0% Load, 220Vac input)

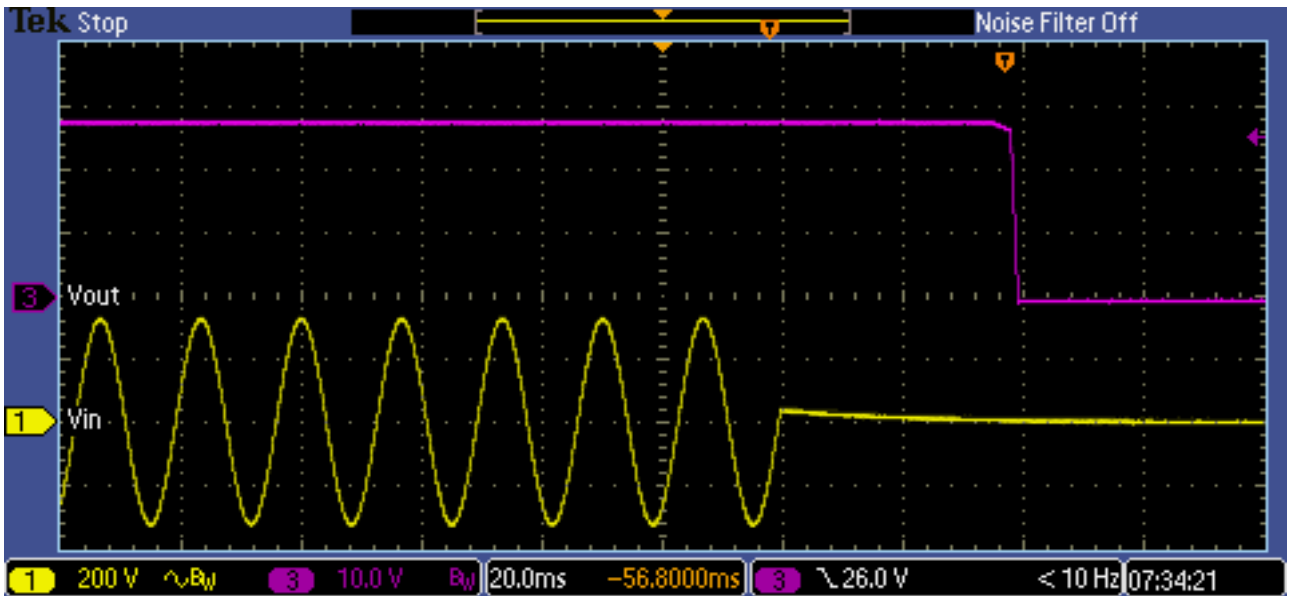

Vin: 200V/div Vout: 10V/div 20ms/div
 Output fall (100% Load, 220Vac input)

2.7 Output rise and fall characteristics with ON/OFF control.

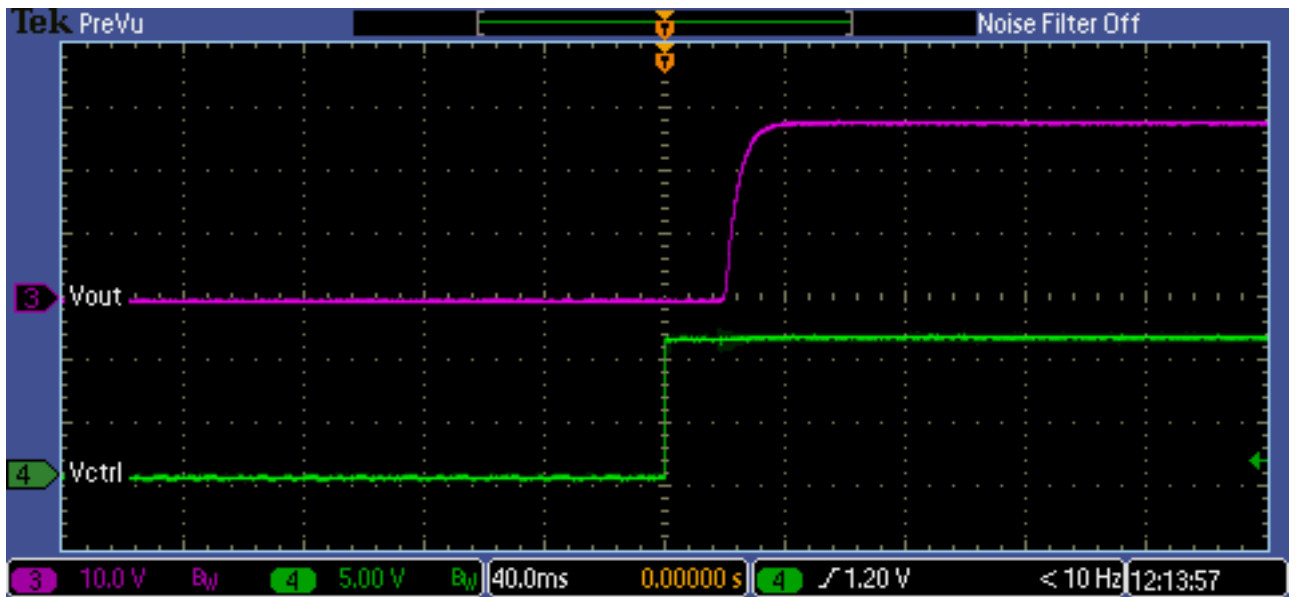

Vctrl: 5V/div Vout: 10V/div 40ms/div
Output rise with ON/OFF control(0% Load, 110Vac input)

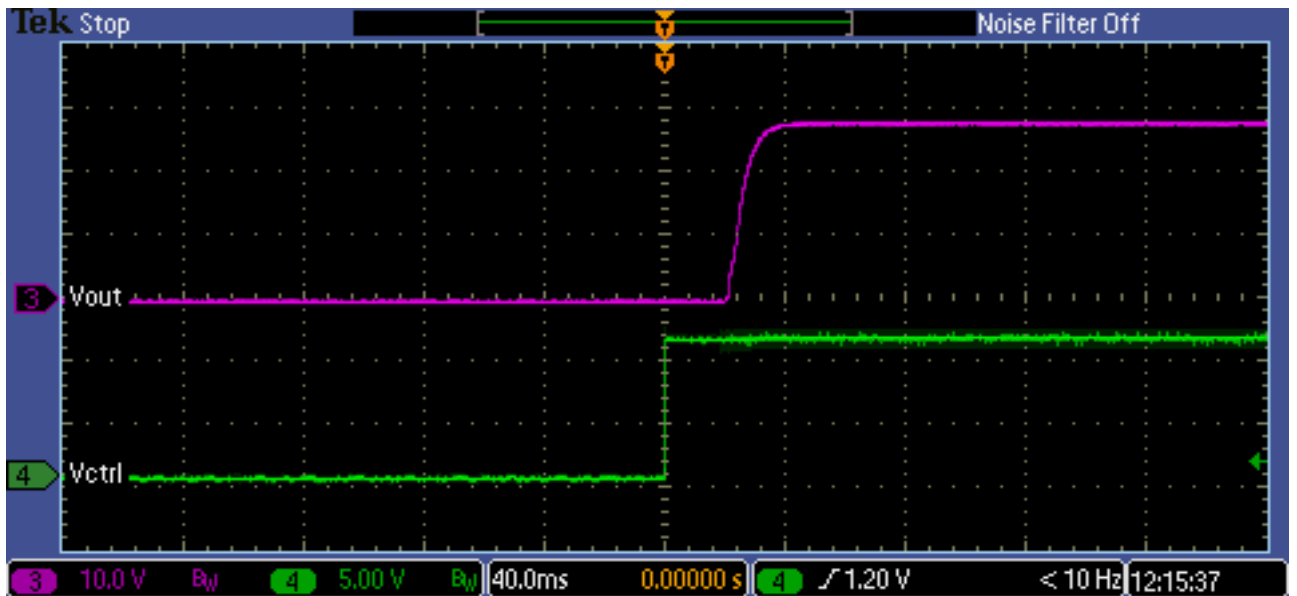

Vctrl: 5V/div Vout: 10V/div 40ms/div
Output rise with ON/OFF control(100% Load, 110Vac input)

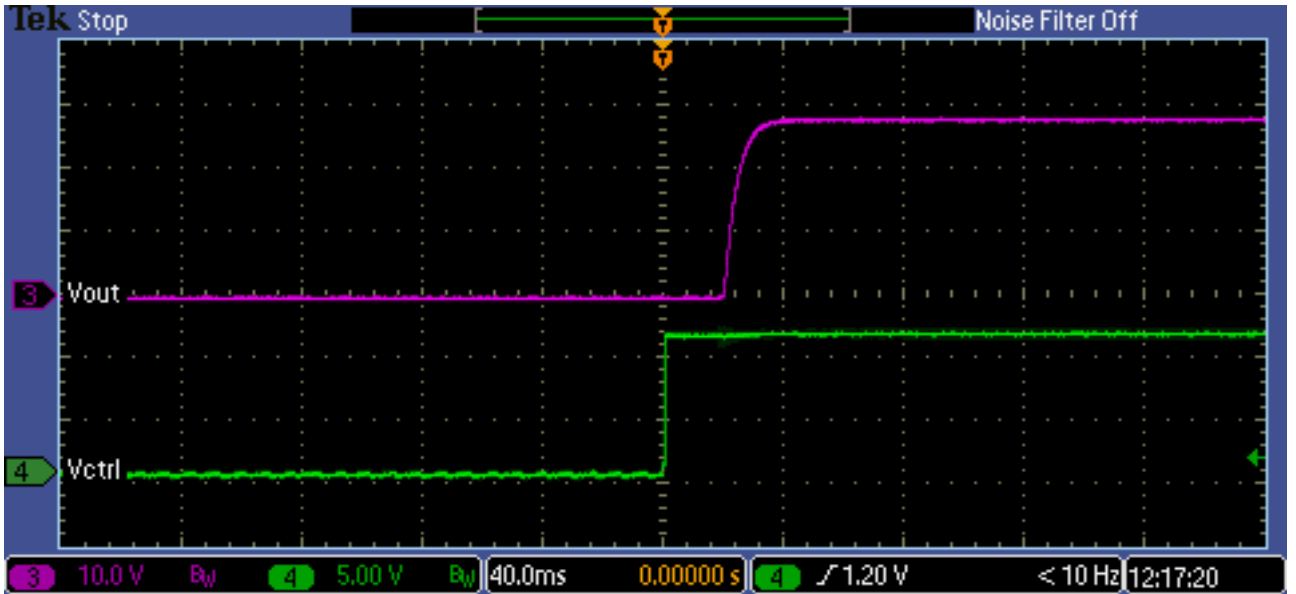

Vctrl: 5V/div Vout: 10V/div 40ms/div
 Output rise with ON/OFF control(0% Load, 220Vac input)

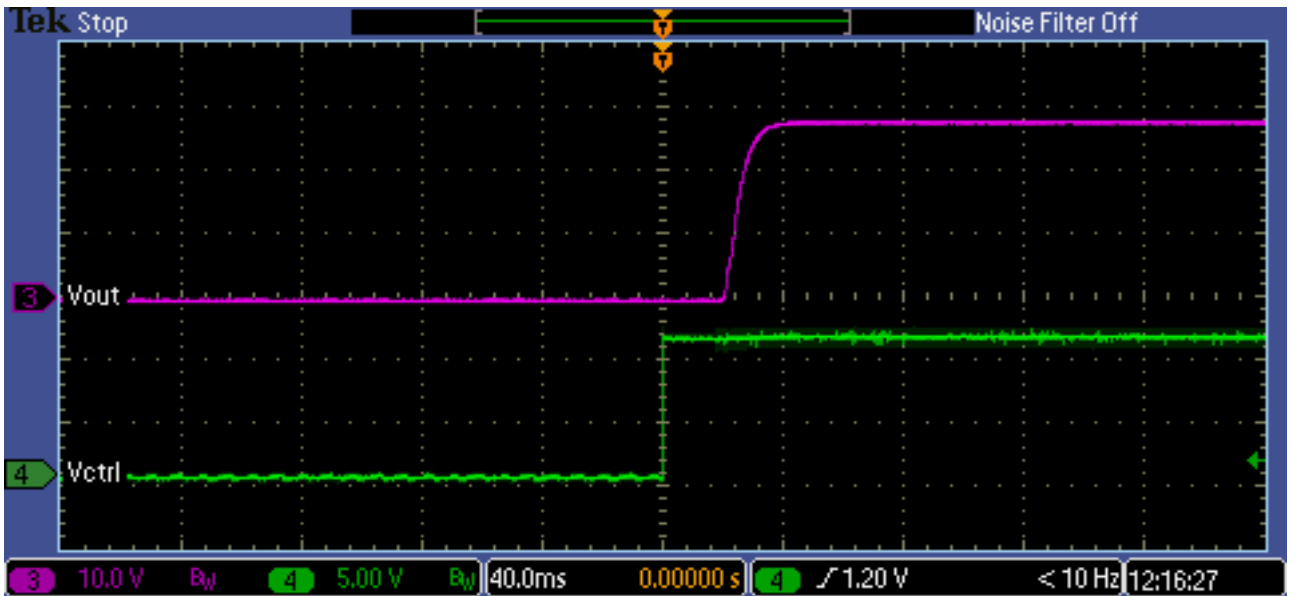

Vctrl: 5V/div Vout: 10V/div 40ms/div
 Output rise with ON/OFF control(100% Load, 220Vac input)

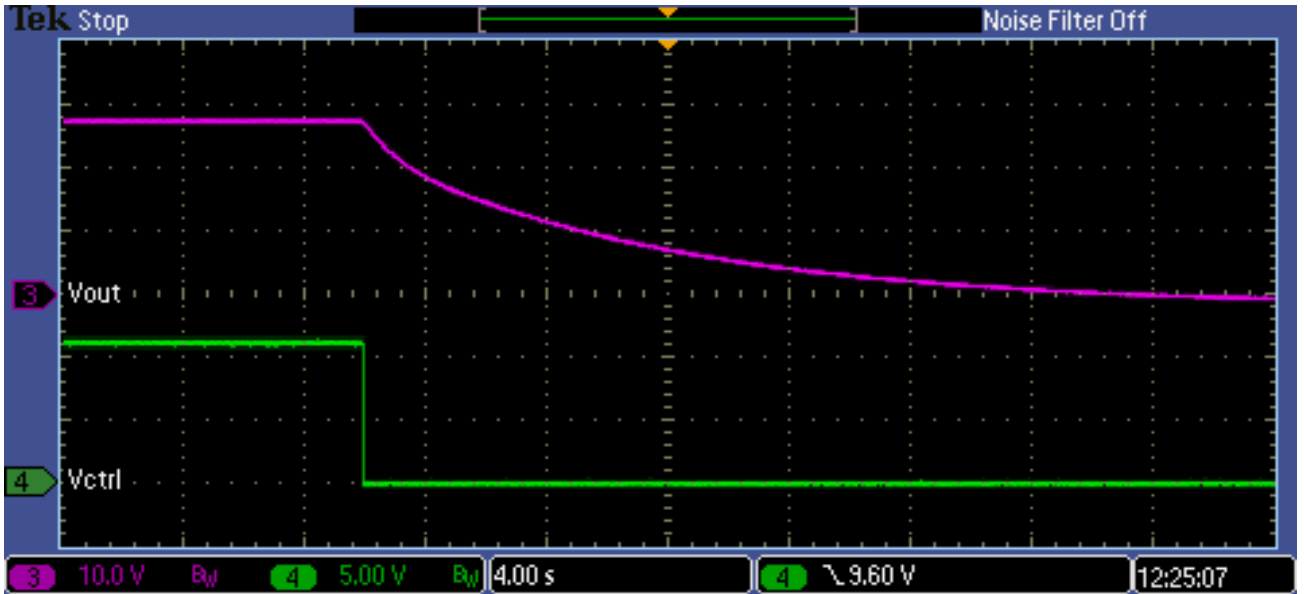

Vctrl: 5V/div Vout: 10V/div 4s/div
 Output fall with ON/OFF control(0% Load, 110Vac input)



Vctrl: 5V/div Vout: 10V/div 400us/div
 Output fall with ON/OFF control(100% Load, 110Vac input)

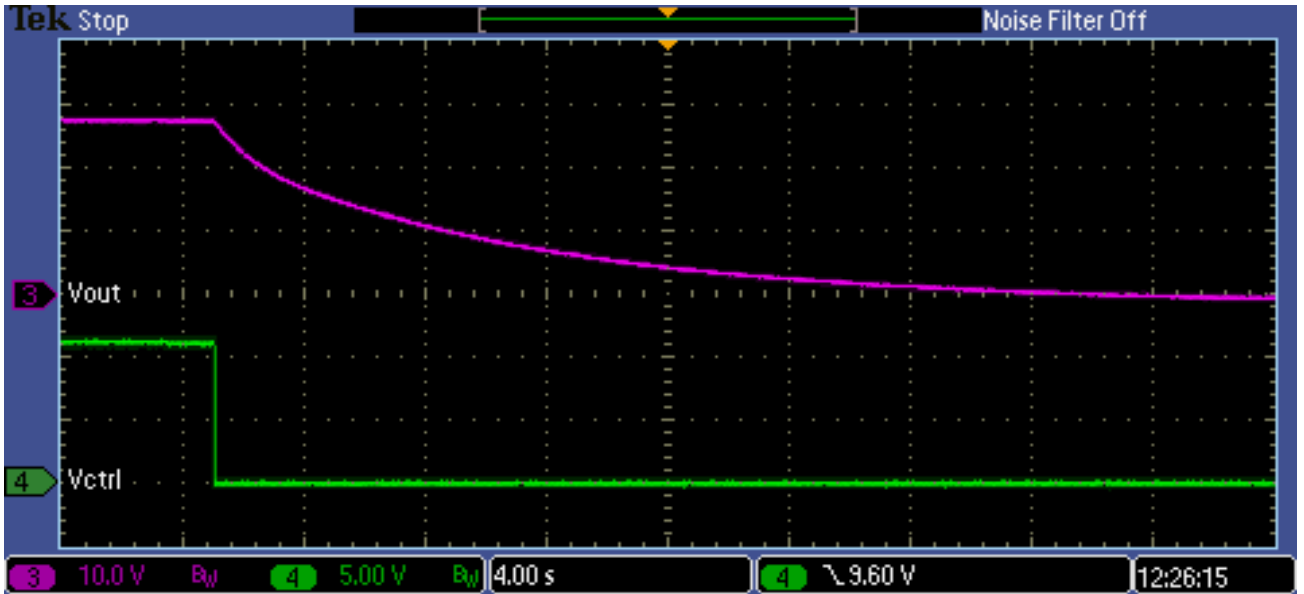

Vctrl: 5V/div Vout: 10V/div 4s/div
 Output fall with ON/OFF control(0% Load, 220Vac input)

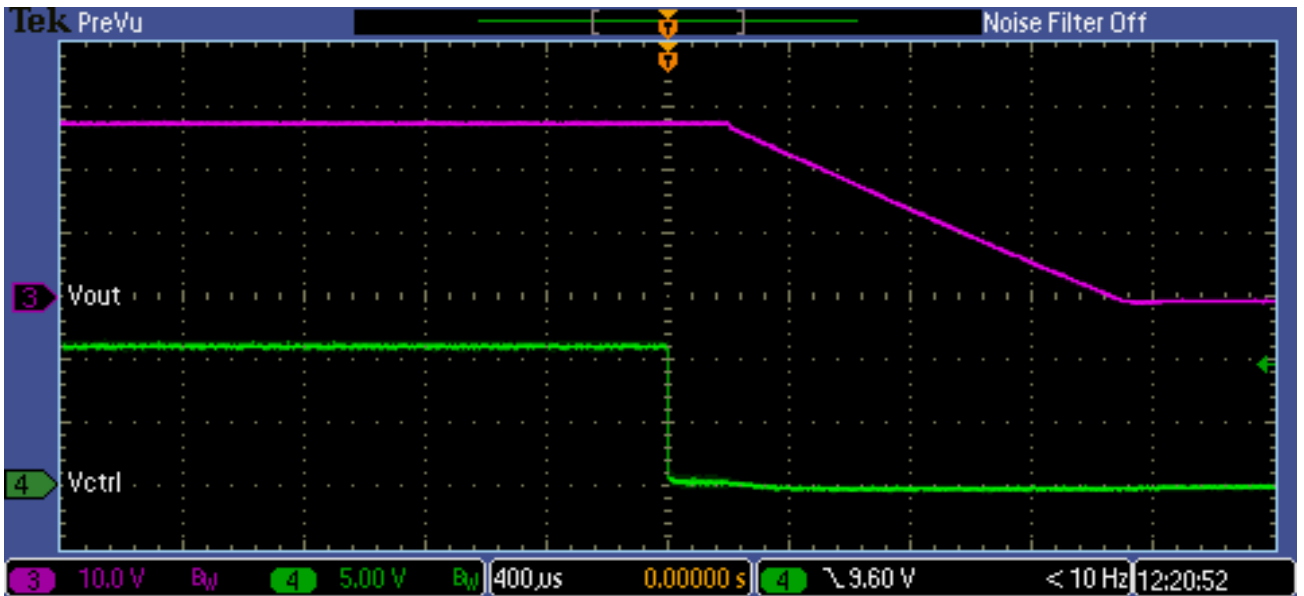

Vctrl: 5V/div Vout: 10V/div 400us/div
 Output fall with ON/OFF control(100% Load, 220Vac input)

2.8 Hold up time characteristics

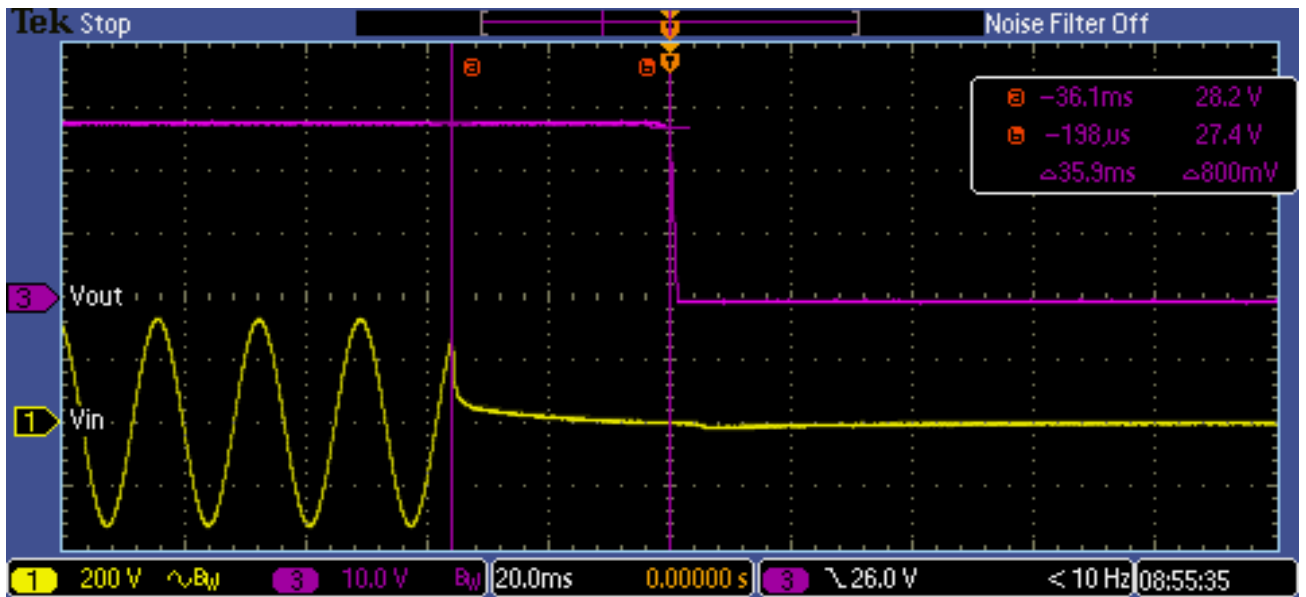

Vin: 200V/div Vout: 5V/div 20ms/div
 Output fall with ON/OFF control(100% Load, 220Vac input)

Load (%)	Hold up time (ms)
20	162
40	87
60	58
80	47
100	36

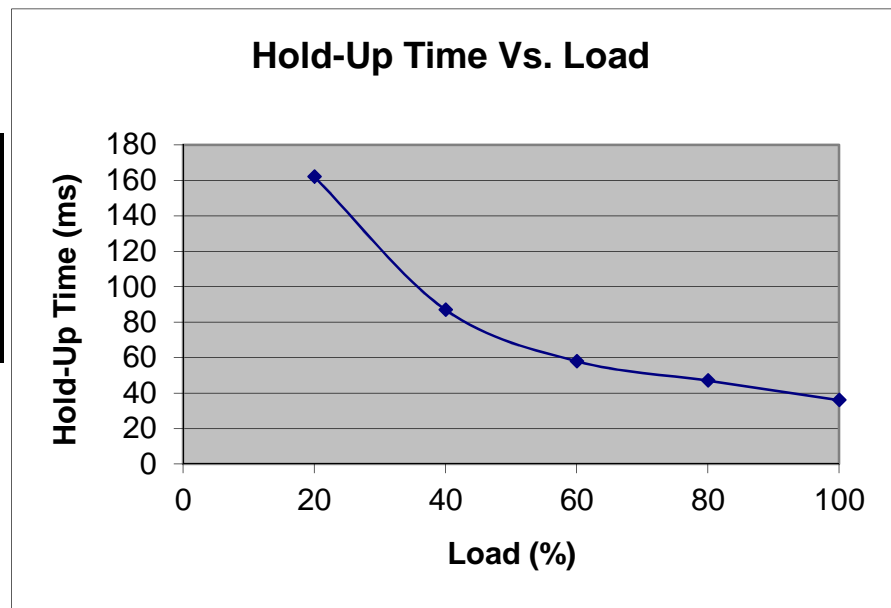

2.9 Dynamic line response characteristics

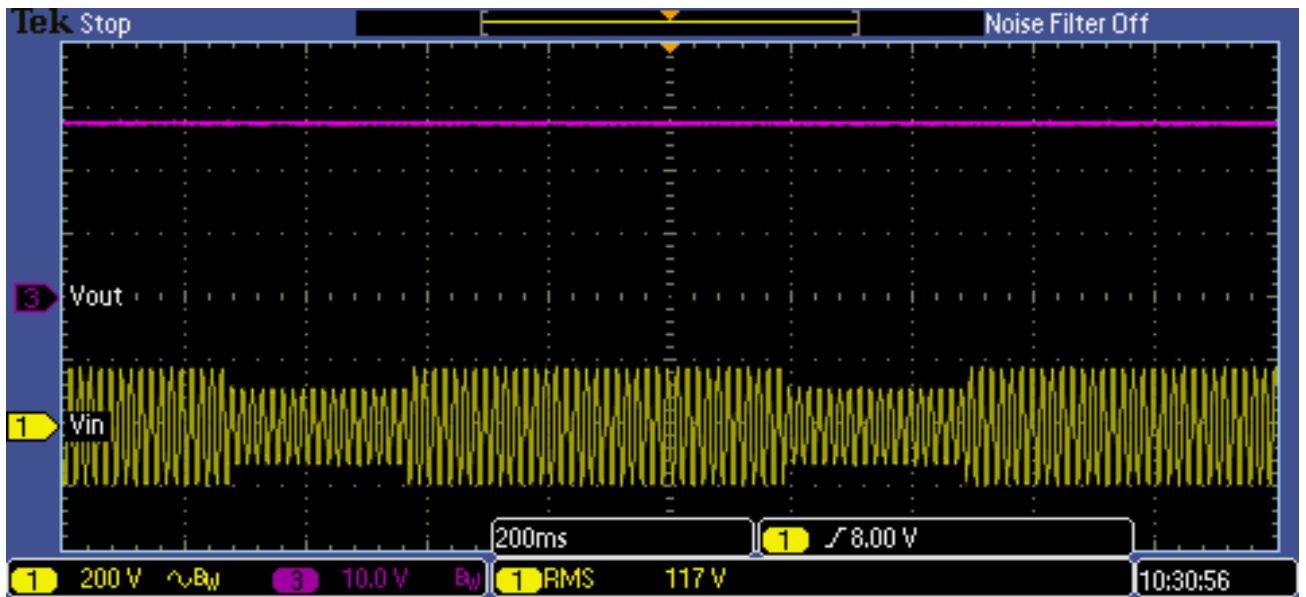

Vin: 200V/div Vout: 10V/div 200ms/div
Vin: 90VAC \iff 135VAC (100% Load)

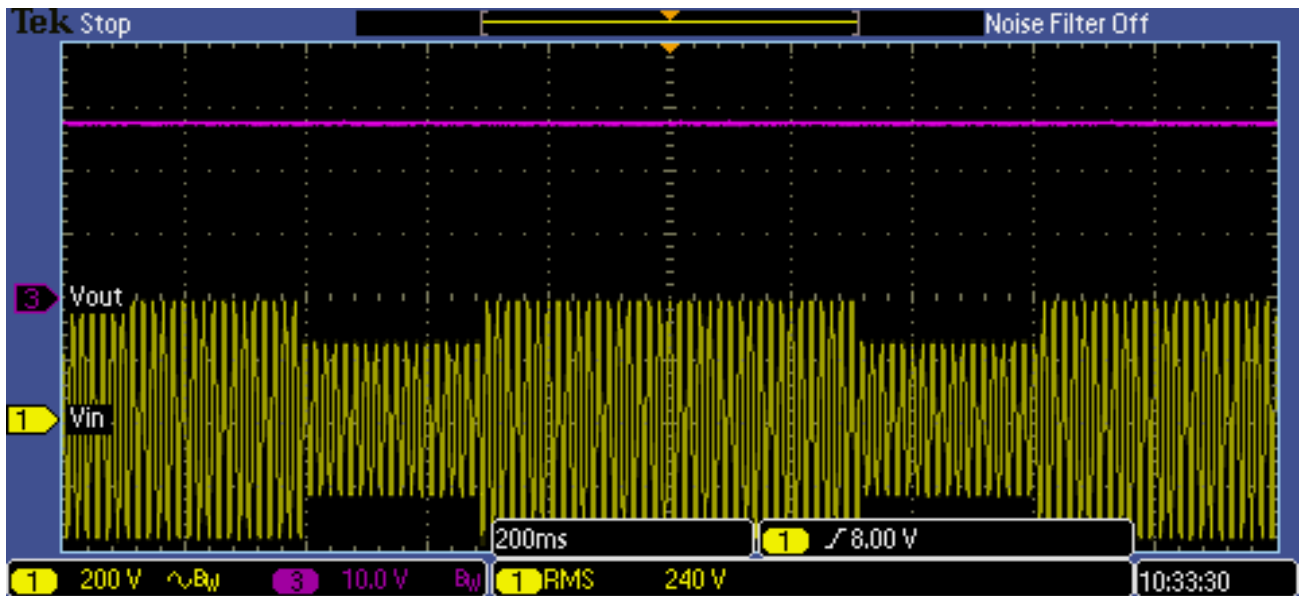

Vin: 200V/div Vout: 10V/div 200ms/div
Vin: 170VAC \iff 265VAC (100% Load)

2.10 Dynamic load response characteristics

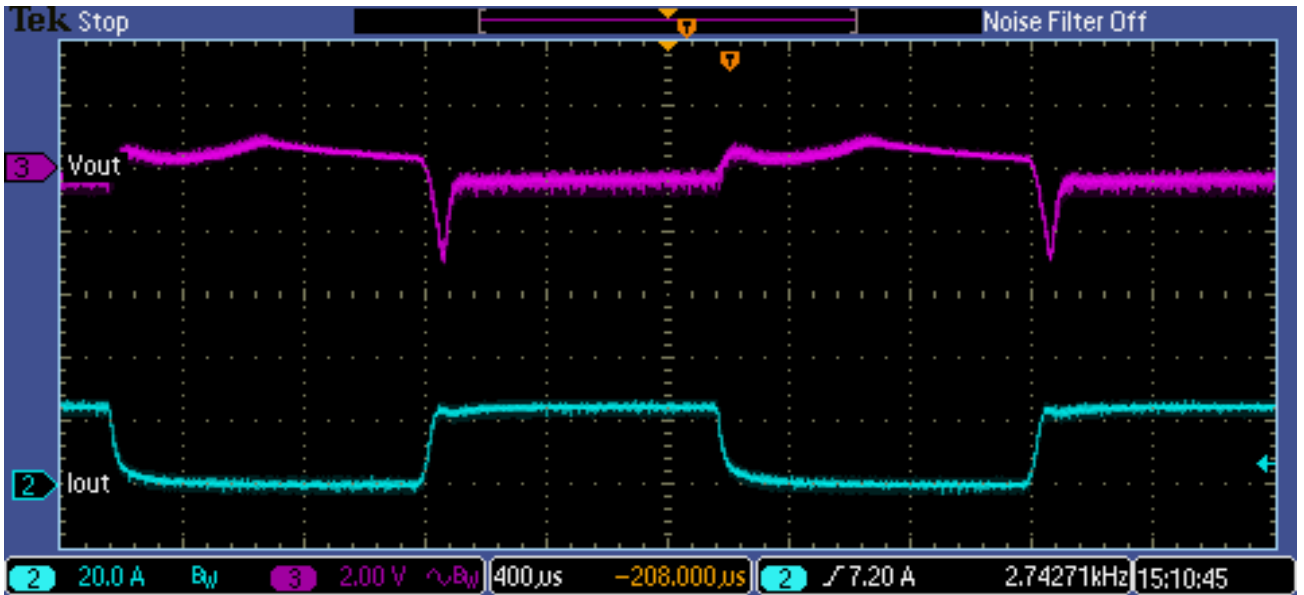

Iout: 20A/div Vout: 2V/div 400us/div
Dynamic Load Response (0% to 50% Load, 110Vac input)

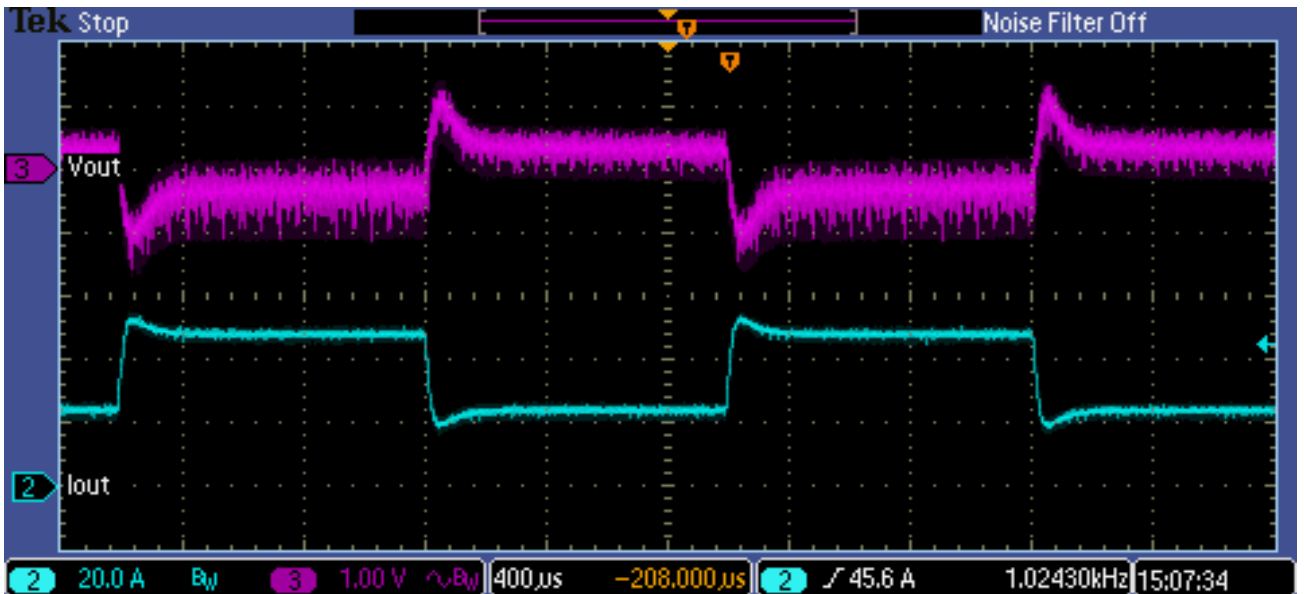

Iout: 20A/div Vout: 1V/div 400us/div
Dynamic Load Response (50% to 100% Load, 110Vac input)

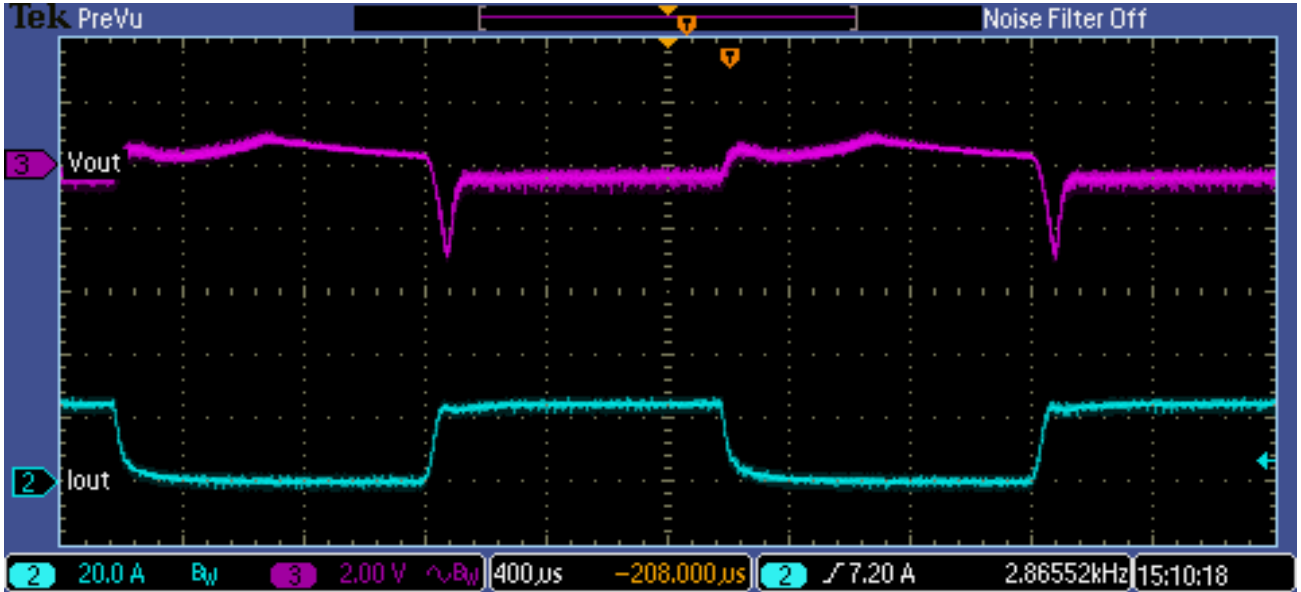

Iout: 20A/div Vout: 2V/div 400us/div
 Dynamic Load Response (0% to 50% Load, 220Vac input)

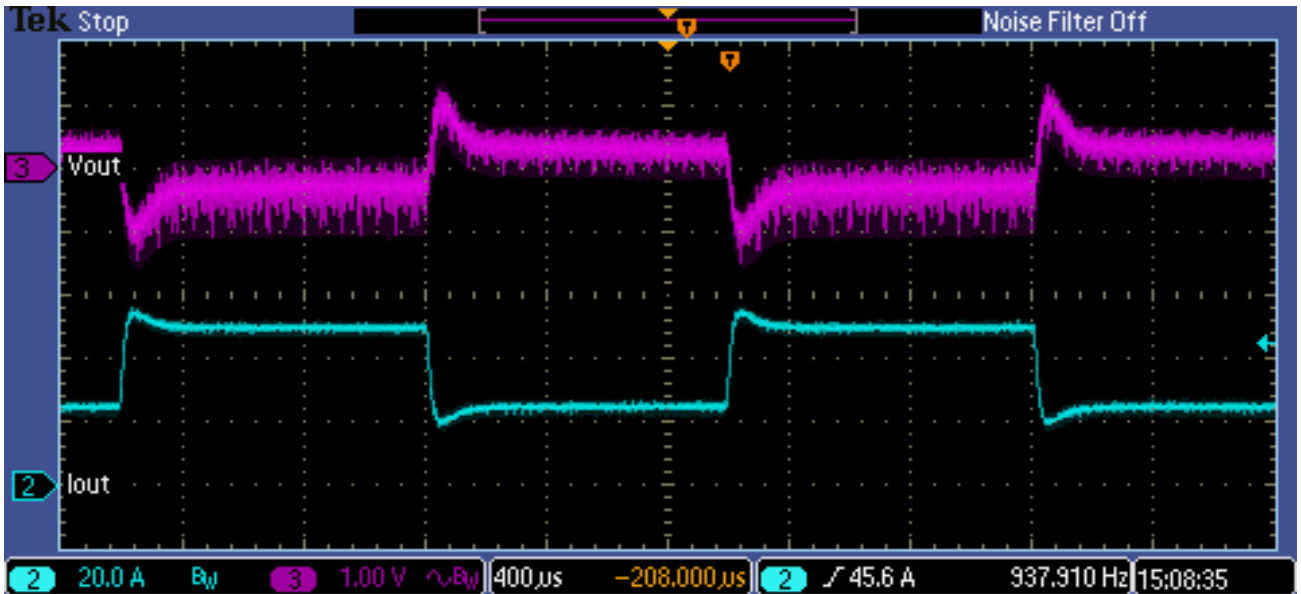

Iout: 20A/div Vout: 1V/div 400us/div
 Dynamic Load Response (50% to 100% Load, 220Vac input)

2.11 Response to brownout characteristics

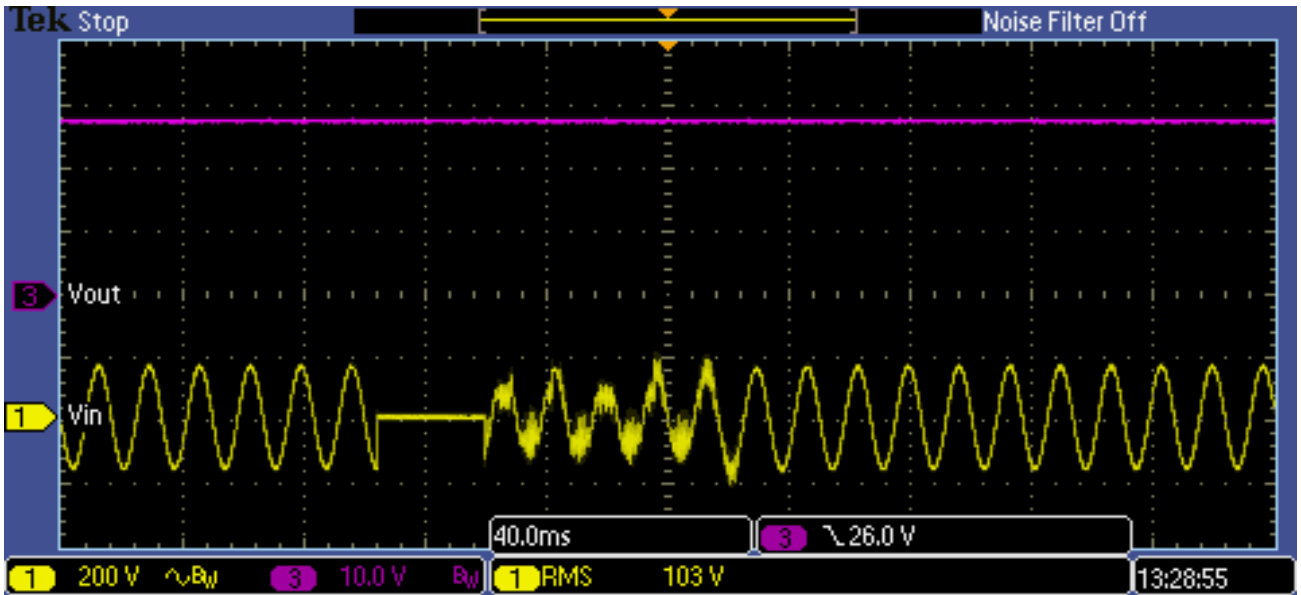

Vin: 200V/div Vout: 10V/div 40ms/div
 Vin: 110VAC - 35mS Dropout (100% Load)

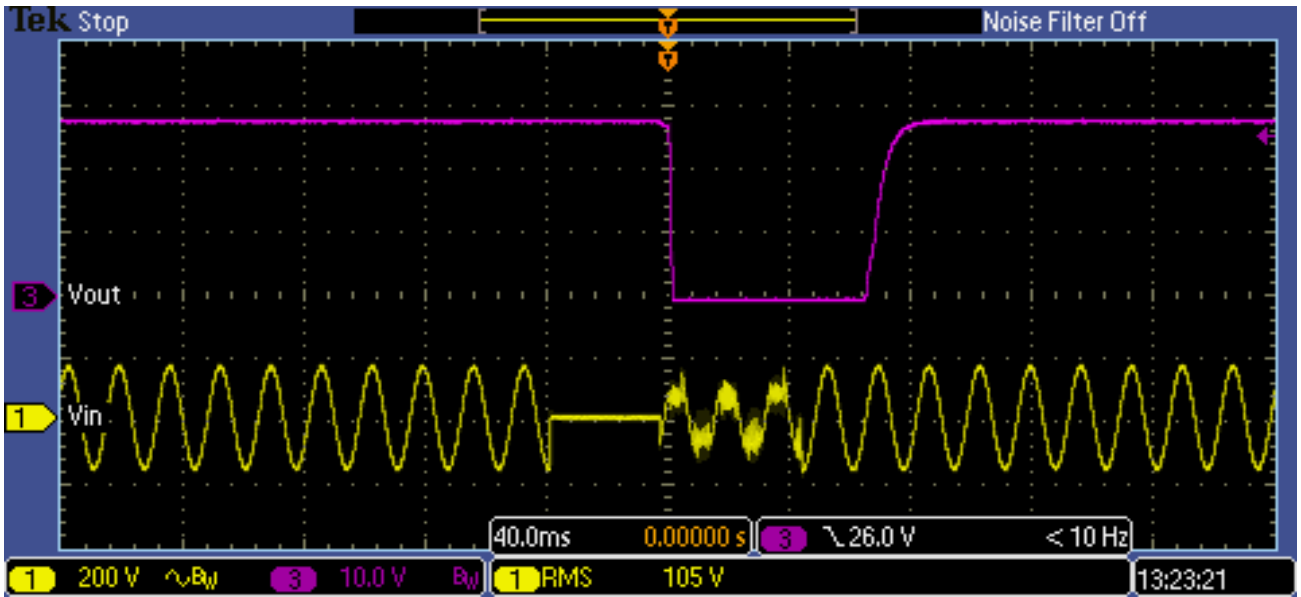

Vin: 200V/div Vout: 10V/div 40ms/div
 Vin: 110VAC - 36mS Dropout (100% Load)

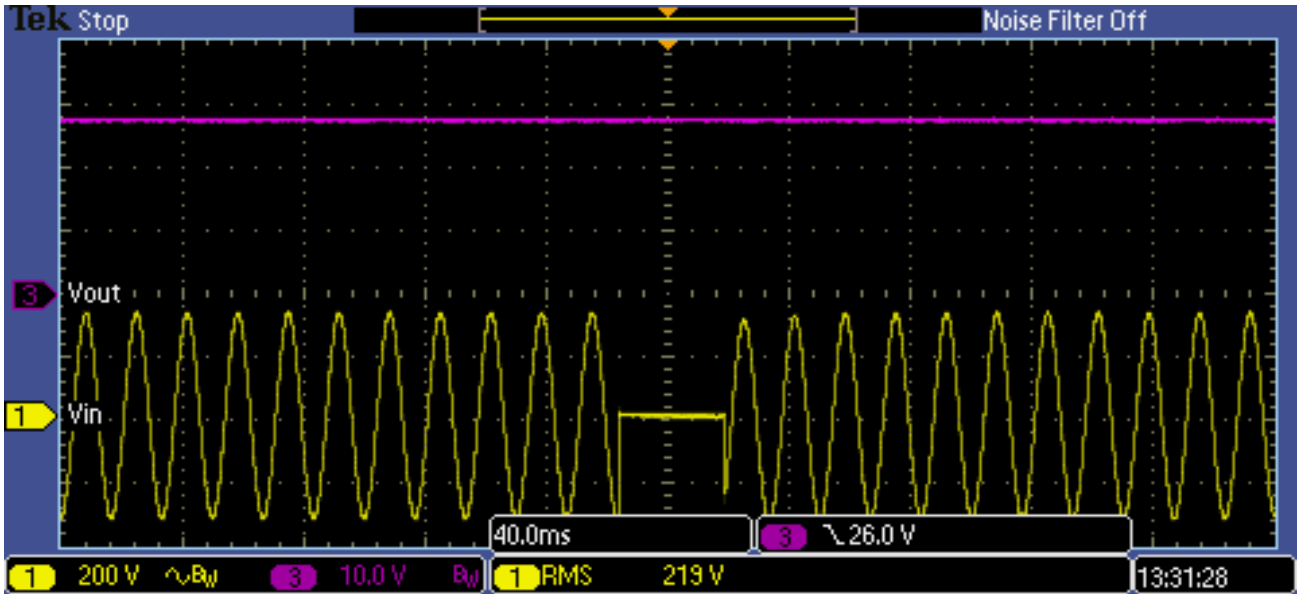

Vin: 200V/div Vout: 10V/div 40ms/div
 Vin: 220VAC - 35mS Dropout (100% Load)

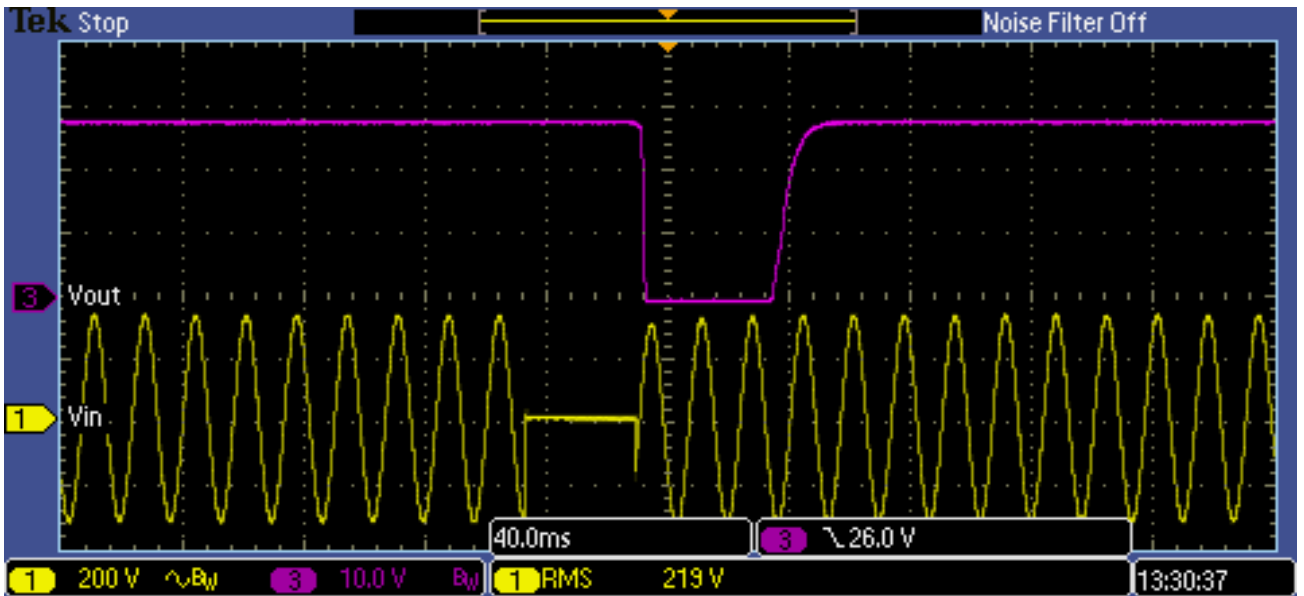

Vin: 200V/div Vout: 10V/div 40ms/div
 Vin: 220VAC - 36mS Dropout (100% Load)

2.12 Inrush current characteristics

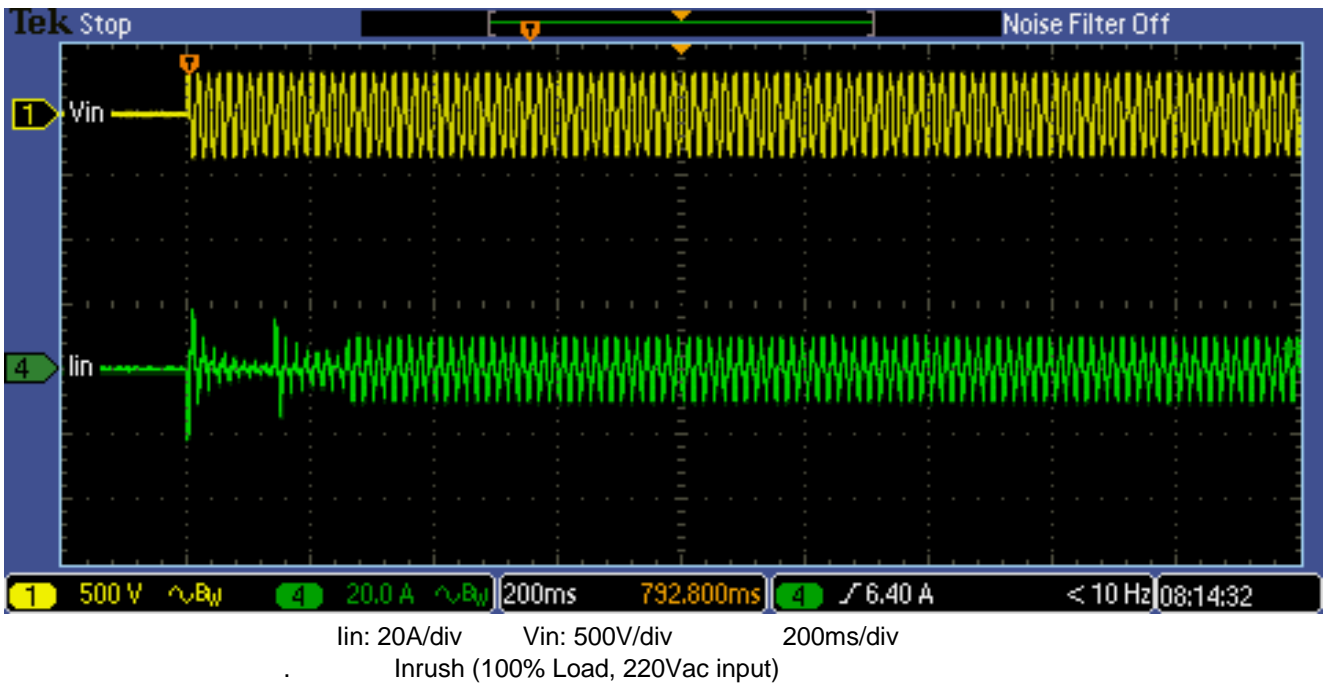
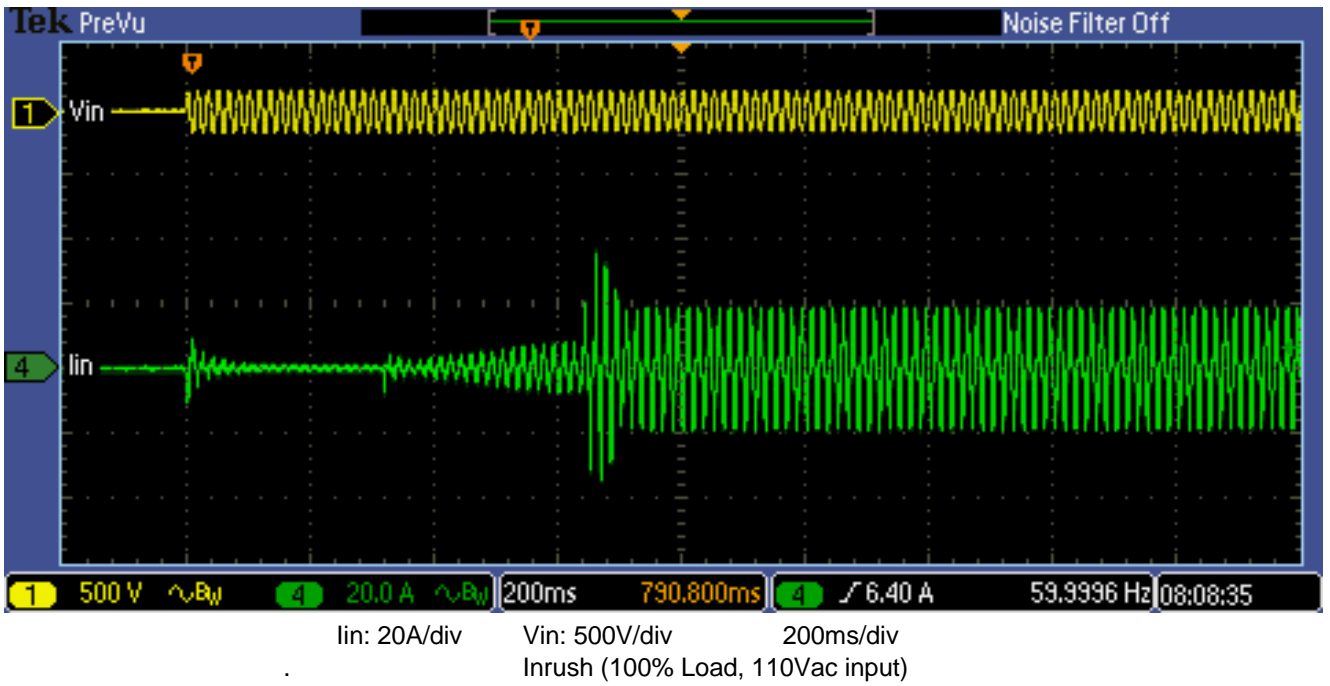

2.13 Input current waveforms

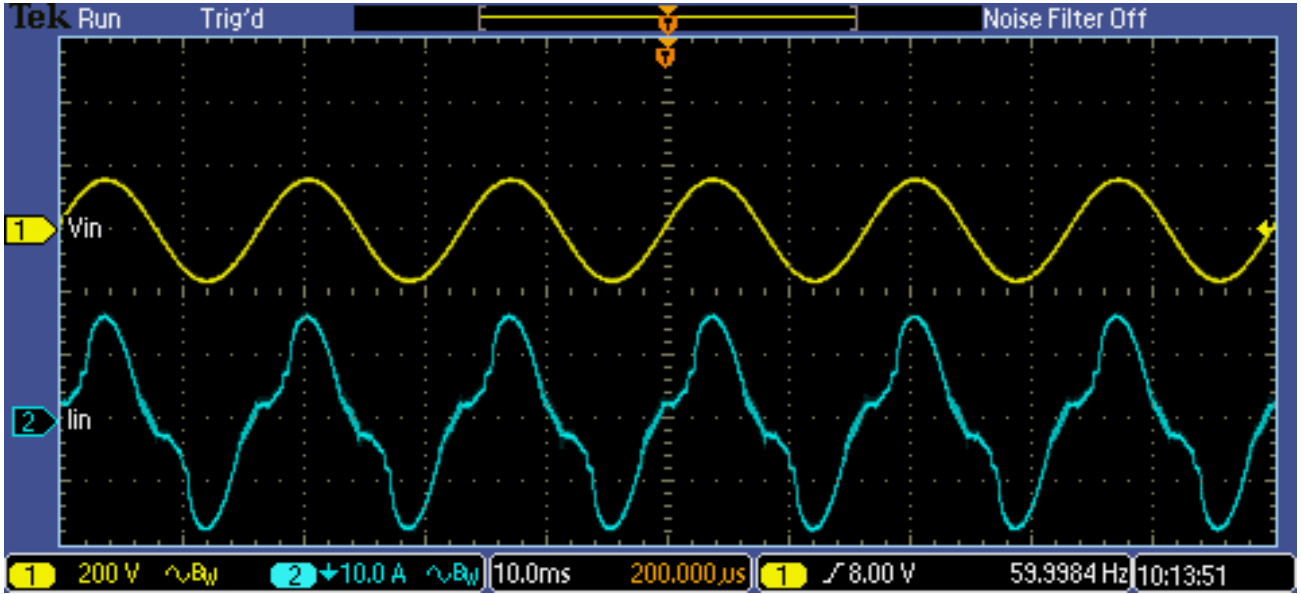

Iin: 10A/div Vin: 200V/div 10ms/div
Input current (100% Load, 110VAC input)

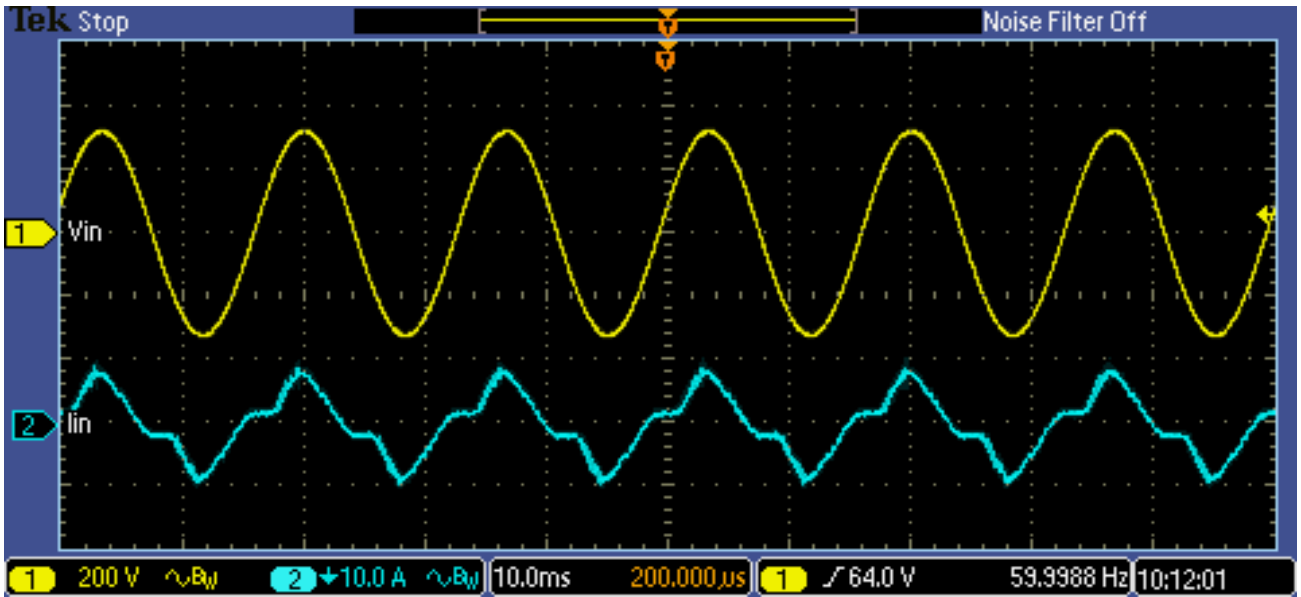

Iin: 10A/div Vin: 200V/div 10ms/div
Input current (100% Load, 220VAC input)

2.14 Input current harmonics

CPFE1000F-28		
Vin	230 VAC	
Freq	50 HZ	
Io	36 ADC	
Vo	28VDC	
Iin	5.2512	
Harmonics	Limit (A)	A
2	1.08	0.0313
3	2.3	1.355
4	0.43	0.011
5	1.14	0.4397
6	0.3	0.0069
7	0.77	0.0367
8	0.23	0.003
9	0.4	0.0527
10	0.184	0.0038
11	0.33	0.0368
12	0.153	0.0049
13	0.21	0.0515
14	0.131	0.0022
15	0.15	0.0501
16	0.11	0.0029
17	0.132	0.0191
18	0.102	0.0023
19	0.118	0.0135
20	0.092	0.0038
21	0.107	0.0119
22	0.084	0.0007
23	0.098	0.044
24	0.077	0.0026
25	0.09	0.0044
26	0.071	0.0015
27	0.083	0.019
28	0.066	0.0017
29	0.078	0.0131
30	0.061	0.0021
31	0.073	0.0367
32	0.058	0.0027
33	0.068	0.0151
34	0.054	0.0055
35	0.064	0.0325
36	0.051	0.0011
37	0.061	0.0312
38	0.048	0.0043
39	0.058	0.0166
40	0.046	0.003

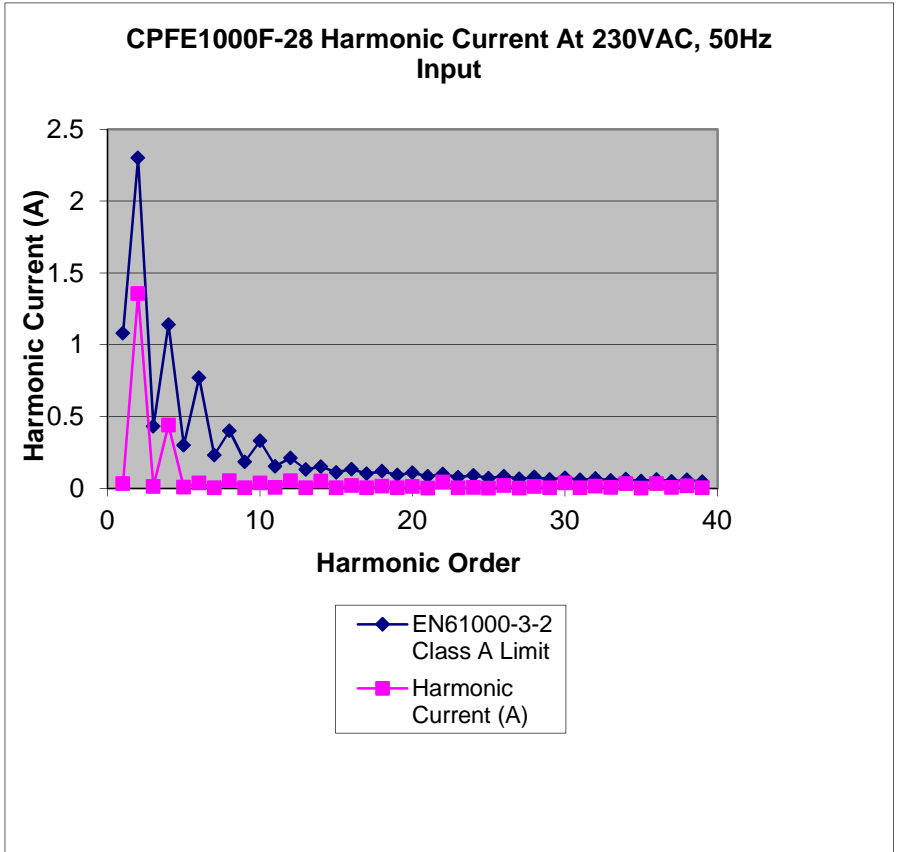

2.15 Leakage current characteristics

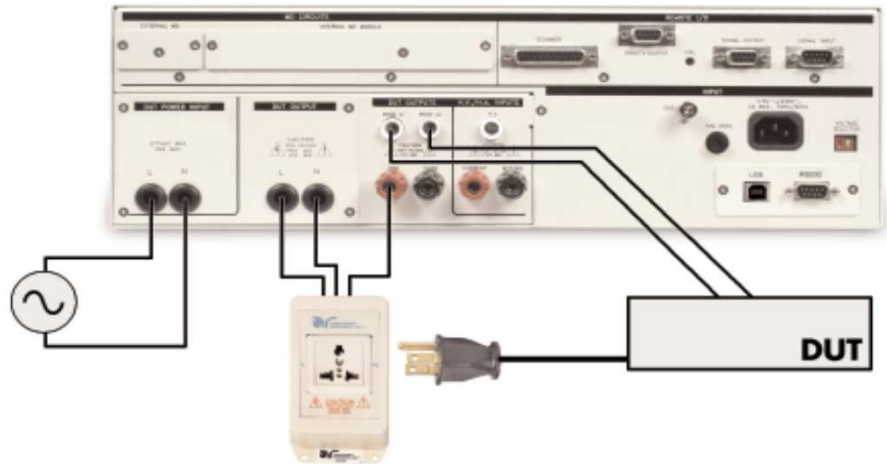
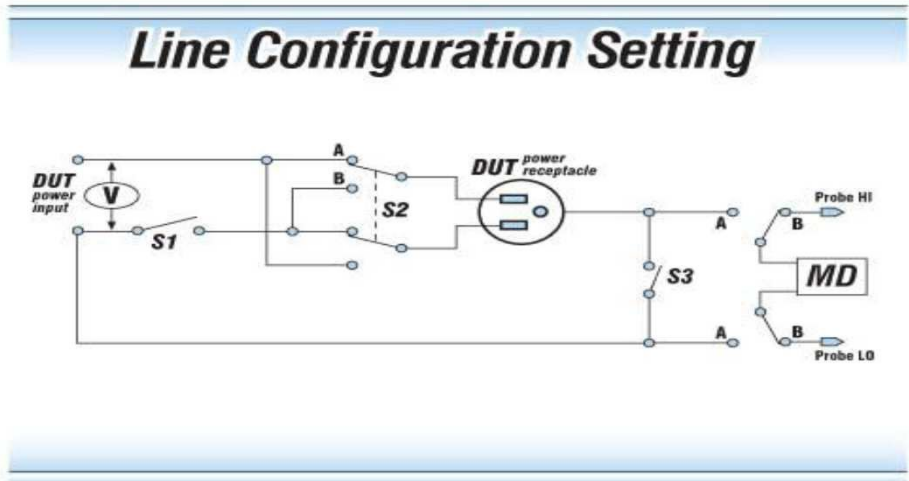

PS Vout	Time (s)	Freq (Hz)	Nom.1 110VAC	Nom.2 220VAC	HI 265Vac	Configuration		
						Neutral	S2	S3
28	10	60	<1.5mA	<1.5mA	<1.5mA	Closed	Normal	Open
	10	60	0.2550	0.5440	0.6650	Closed	Reverse	Open

2.16 Output ripple and noise waveforms

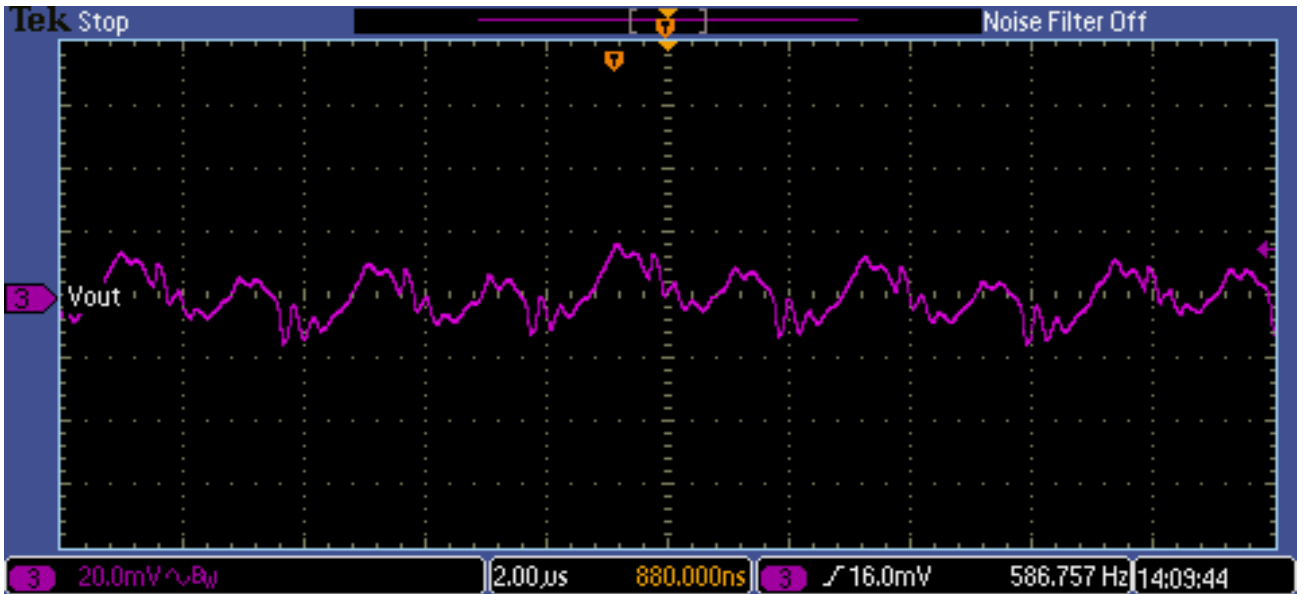

Vout: 20mV/div 2 μ s/div
Output Ripple (100% Load, 110VAC input)

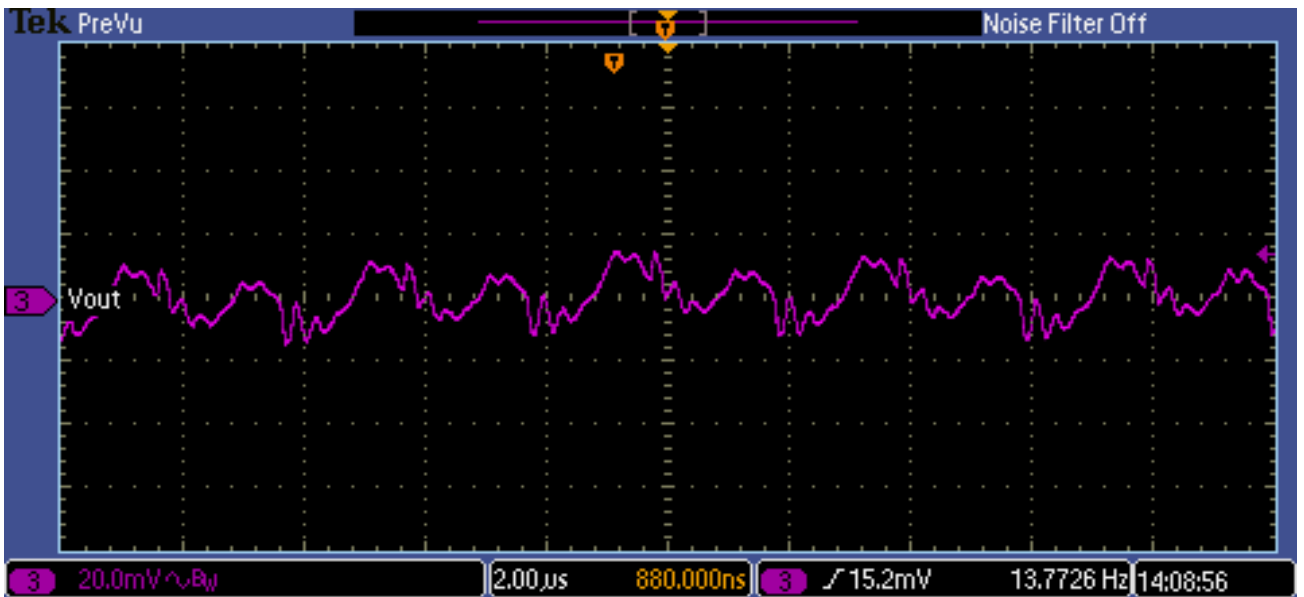

Vout: 20mV/div 2 μ s/div
Output Ripple (100% Load, 220VAC input)