

32.768kHz LOW POWER SMD CRYTAL OSCILLATOR

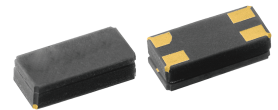

3.2 x 1.5 x 1.0mm

ASH7KW



ESD Sensitive



RoHS/RoHS II Compliant

Moisture Sensitivity Level (MSL) – Level 1

FEATURES:

- Ultra-miniature size 3.2x1.5x1.0mm [max.]
- Low Voltage Operation (Min:1.2V)
- Low Current Consumption
- Operating temperature : -40 to +85 °C; -40 to +125 °C
- VDD controls the output amplitude

APPLICATIONS:

- Factory Automation
- PC Server
- W-LAN/GPS Chipset
- General purpose clock generator for digital systems
- Clock drivers for Real Time Clocks
- Timekeeping in network servers and computers
- Electricity, gas and water metering
- Portable field communication
- Mobile phone
- Clock & Data recovery
- CCD clock for VTR camera
- Computers and peripherals
- Portable MP3 players & games

STANDARD SPECIFICATIONS

Parameters	Minimum	Typical	Maximum	Units	Notes
Output Frequency	32.768			kHz	
Operating Temperature	-40		+85	°C	Option "L"
	-40		+125		Option "H"
Storage Temperature	-55		+125	°C	
Turnover Temperature	+20	+25	+30	°C	
Frequency Tolerance	-20		+20	ppm	
Temperature Coefficient	-0.035±10%			ppm/C ²	
Supply Voltage Range (V _{dd})	1.2		5.5	V	
Current Consumption		0.3	0.5	μA	V _{dd} =3.0V, \overline{OE} (output disabled)
Current Consumption		1.8		μA	Load=15pF, V _{dd} =3.0V, OE
Output Load (CMOS)			15	pF	
Output Voltage	V _{OH}	V _{dd} -0.4		V	I _{OH} = -1mA
	V _{OL}		GND+0.4		I _{OL} = 1mA
CLKOE Pin Function	"1" (VIH≥0.8*Vdd) or Open: Oscillation "0" (VIL<0.2*Vdd) : Output disabled				
Aging@+25	-3.0		+3.0	ppm	First year
Duty Cycle	40		60	%	
Voltage Coefficient	-1.5		+1.5	ppm/V	
Start-up Time			0.5	s	
Output Rise Time			70.0	ns	Load=10pF, 10% to 90%
Output Fall Time			70.0	ns	Load=10pF, 10% to 90%

TYPICAL FREQUENCY TEMPERATURE CHARACTERISTICS:

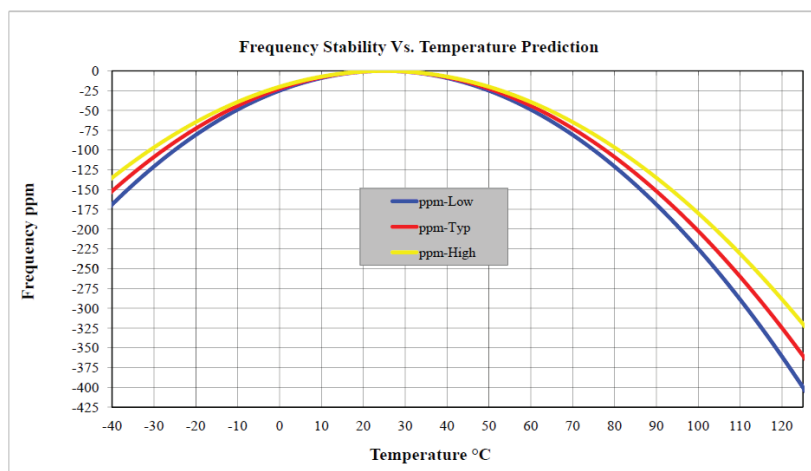

32.768kHz LOW POWER SMD CRYTAL OSCILLATOR

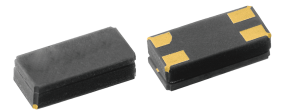

3.2 x 1.5 x 1.0mm

ASH7KW

RoHS/RoHS II Compliant

PART IDENTIFICATIONS:

ASH7KW-32.768kHz-□-□

Operating Temp.

L: -40°C ~ +85°C

H: -40°C ~ +125°C

Packaging

Blank: Bulk

T: 1000pcs/Reel

T3: 3000pcs/Reel

OUTLINE DIMENSIONS:

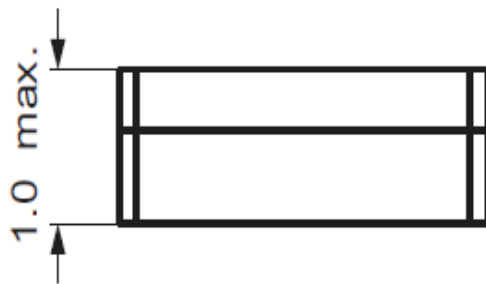
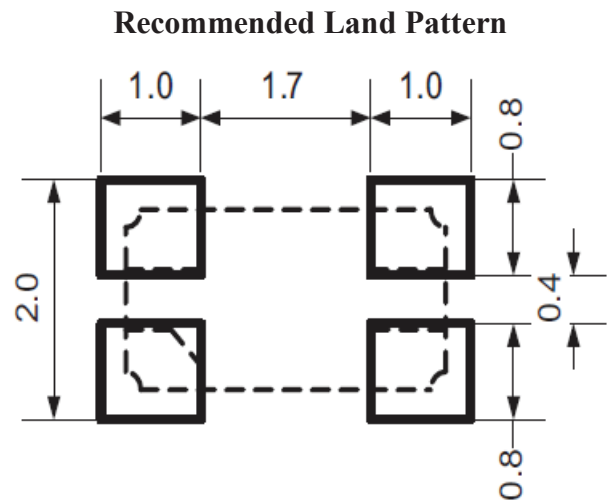
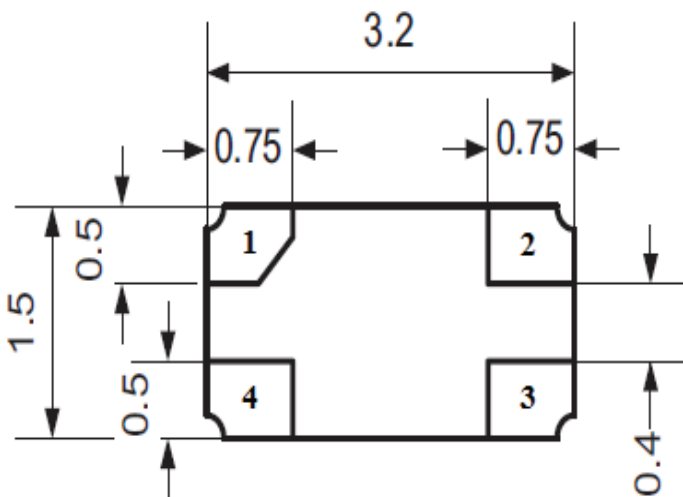

Pin No.	Function
1	Output
2	GND
3	OE
4	Vdd

Note: Due to material availability, the component cover may vary (ceramic or metal). This variation in no way affects the electrical performance of the product.

Dimensions: mm

All Dimensions are typical values.

32.768kHz LOW POWER SMD CRYTAL OSCILLATOR

ASH7KW

 RoHS/RoHS II Compliant

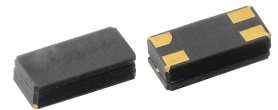

3.2 x 1.5 x 1.0mm

REFLOW PROFILE:

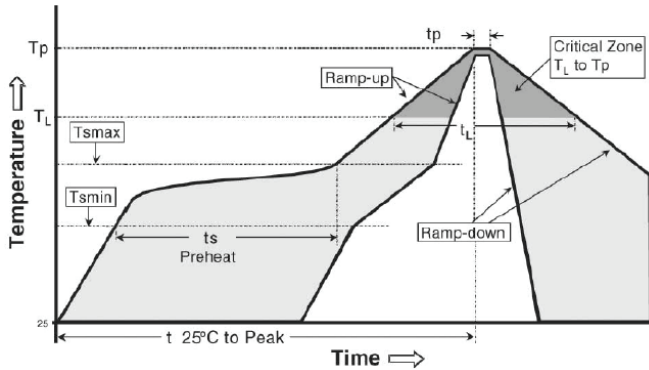

Temperature Range	Symbol	Condition	Unit
Average Ramp up Rate	(T _{Smax} to T _p)	3°C/second max	°C/s
Ramp Down Rate	T _{cool}	6°C/second max	°C/s
Time 25°C at Peak Temperature	T _{to-peak}	8 minutes max	m
Preheat			
Temperature Min	T _{Smin}	150	°C
Temperature Max.	T _{Smax}	200	°C
Time T _{Smin} to T _{Smax}	T _s	60-180	Sec
Soldering above Liquidus			
Temperature Liquidus	T _L	217	°C
Time above Liquidus	t _L	60-150	Sec
Peak Temperature			
Peak Temperature	T _p	260	°C
Time within 5°C of Peak Temperature	t _p	20-40	Sec

TAPE & REEL:

T= Tape and reel (1,000pcs/reel)
T3= Tape and reel (3,000pcs/reel)

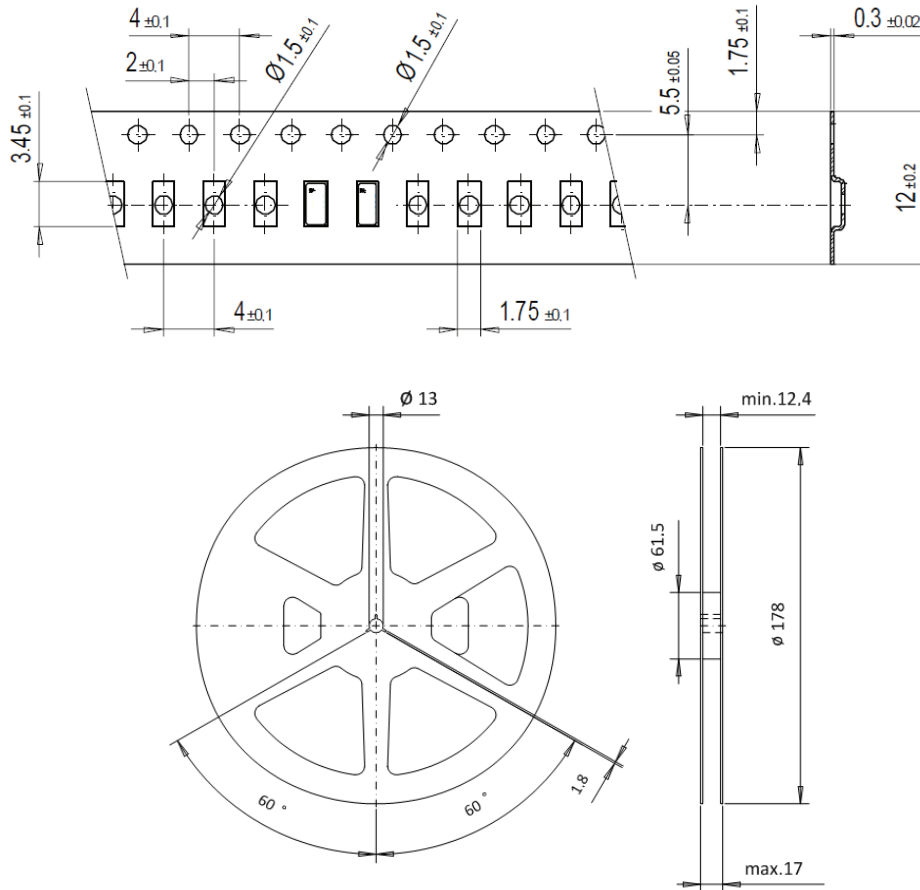

Dimensions: mm

ATTENTION: Abracon LLC's products are COTS – Commercial-Off-The-Shelf products; suitable for Commercial, Industrial and, where designated, Automotive Applications. Abracon's products are not specifically designed for Military, Aviation, Aerospace, Life-dependent Medical applications or any application requiring high reliability where component failure could result in loss of life and/or property. For applications requiring high reliability and/or presenting an extreme operating environment, written consent and authorization from Abracon LLC is required. Please contact Abracon LLC for more information.

ABRACON IS
ISO 9001-2015
CERTIFIED



Revised:07.07.2021

Headquarters: 5101 Hidden Creek Ln Spicewood TX 78669
Phone: 512-371-6159 | Fax: 512-351-8858