

GENERAL TOLERANCE										USED ON
10 MAX	30 MAX	50 MAX	70 MAX	100 MAX	120 MAX	250 MAX	250 OVR	ANGLE	ECCENT	
±0.15	±0.20	±0.30	±0.40	±0.50	±0.75	±0.90	±1.4	±0.5°	0.1	

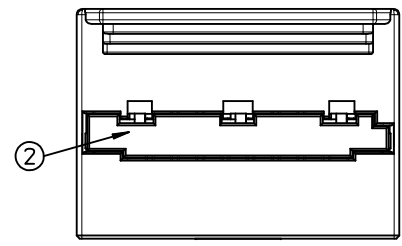
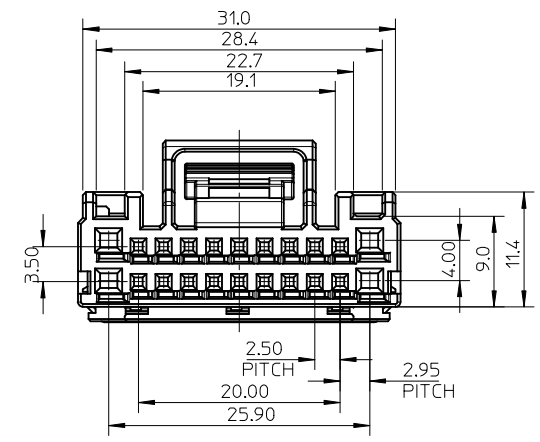
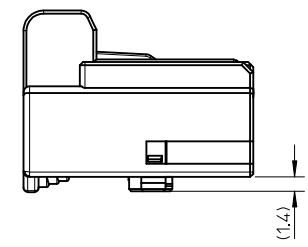
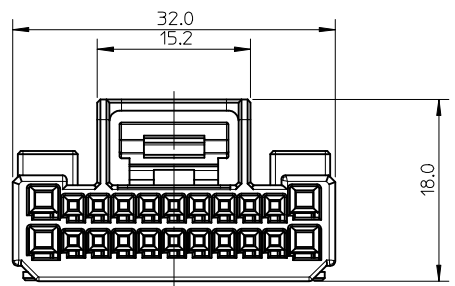
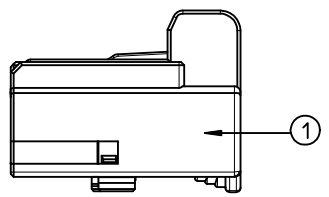
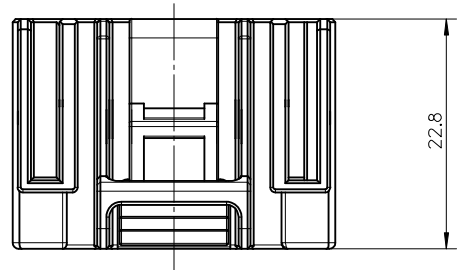
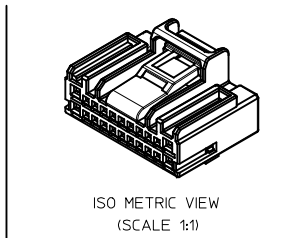

- NOTES
1. MATERIAL : SEE TABLE
 2. GENERAL TOLERANCE : SEE TABLE
 3. APPLICABLE HEADER : 104212-6411
 4. APPLICABLE TERMINAL :

TERMINAL SERIES	PART NO	CRIMPING RANGE	
		SO	WIRE
025	98658-1211	0.30-0.50	AVSS
	98658-1213	0.22-0.50	CHFUS
060	98195-1211	0.30-0.50	
	98195-1212	0.50-0.85	AVSS

NO	DESCRIPTION	MATERIAL	QUANTITY
2	TPA	PBT (YELLOW)	1
1	025 060 HYB FEMALE 22P (A)	PBT (BROWN)	1

1042132221	104213-2221
MATERIAL NO.	ORDER NO.

ENTER DESCRIPTION
EC NO: KTR2015-0077
DRWN: JWK1M02 2015/03/28
CHKD:
APPR: JYCHO1 2015/05/15

QUALITY SYMBOLS	DESCRIPTION
$F_A=0$	
$F_C=0$	
$F_P=0$	

GENERAL TOLERANCES (UNLESS SPECIFIED)	
mm	INCH
4 PLACES ± ---	± ---
3 PLACES ± ---	± ---
2 PLACES ± ---	± ---
1 PLACE ± ---	± ---
0 PLACE ± ---	± ---
ANGULAR ± --- °	
DRAFT WHERE APPLICABLE MUST REMAIN WITHIN DIMENSIONS	

DIMENSION STYLE	
MM ONLY	
DRAWN BY	DATE
JWK1M02	2015/03/28
CHECKED BY	DATE
APPROVED BY	DATE
JYCHO1	2015/05/15
MATERIAL NO.	DOCUMENT NO.
SEE TABLE	SD-104213-001
SIZE A3	THIS DRAWING CONTAINS INFORMATION THAT IS PROPRIETARY TO MOLEX INCORPORATED AND SHOULD NOT BE USED WITHOUT WRITTEN PERMISSION

SCALE 2:1

DESIGN UNITS METRIC

THIRD ANGLE PROJECTION

TITLE 025 060 HYB FEMALE CONNECTOR ASSY 22P_A

molex

SHEET NO. 1 OF 1