

X-X

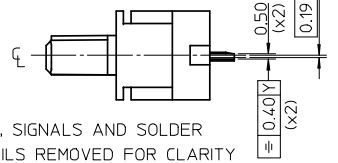

DC, SIGNALS AND SOLDER NAILS REMOVED FOR CLARITY

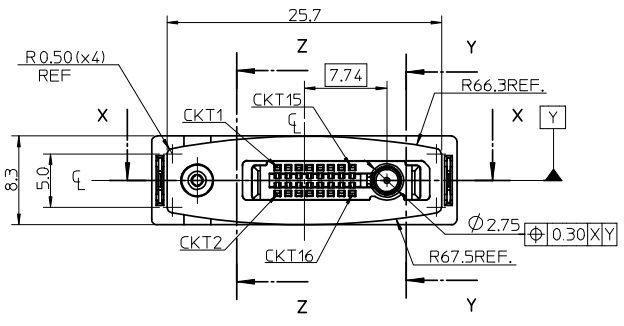
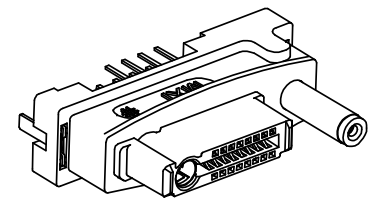

Y-Y

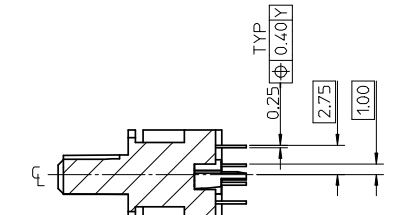

DC AND SOLDER NAILS REMOVED FOR CLARITY

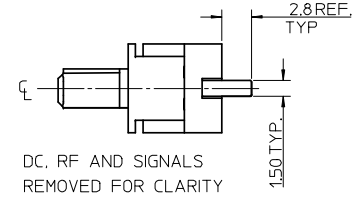
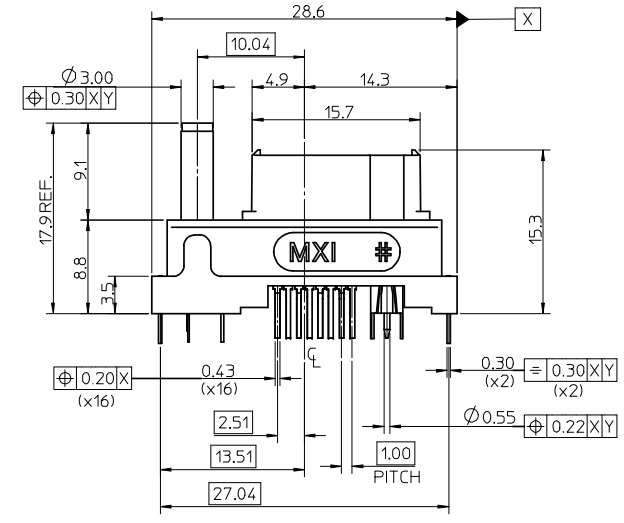
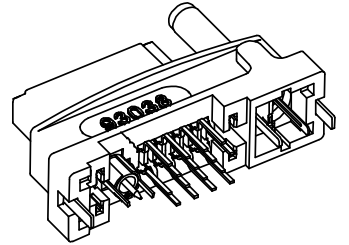

Z-Z

- NOTES:
- MATERIAL:
HOUSING: PA 46. COLOUR BLACK
SIGNAL: PHOSPHOR BRONZE
SOLDER NAIL: PHOSPHOR BRONZE
RF ASSEMBLY:
CENTRE PIN: BRASS
SHIELD: PHOSPHOR BRONZE
DIELECTRIC: LCP. COLOUR BLACK
DC PLUG: 2 POLE 3.00mm OUTER DIAMETER x 0.90mm INTERNAL BEAM INNER DIAMETER
DC CLIP: 0.40mm THICK STAINLESS STEEL
 - PLATING:
SIGNAL: Au OVER PdNi OVER Ni WITH Sn IN SOLDER TAIL AREA
NAIL: Sn OVER Ni UNDERCOAT IN SOLDER TAIL AREA
RF ASSEMBLY:
CENTRE PIN: Au OVER Ni.
SHIELD: Au FLASH OVER PdNi OVER Ni WITH Sn IN THE SOLDER TAIL AREA.
 - CONNECTOR IS RoHS COMPLIANT.
 - PACKAGING: TRAYS
 - PRODUCT SPECIFICATION: PS-93038-001.
 - CONNECTOR IS HAND OR WAVE SOLDER COMPATIBLE ONLY (NOT SUITABLE FOR REFLOW).
 - DATE CODE: TEXT 1.6mm HIGH.

HORIZ DOCK	SIGNALS	HOUSING	DC	RF	NAIL	DC CLIP
QUANTITY	16	1	1	1	2	1

UPDATED TOLERANCE EC NO: E2008-0171 DRAWN: DMAHER 2008/03/05 CHKD: 2008/03/07 APPR: EFOLAN 2008/03/07	QUALITY SYMBOLS ▽=0 ▽=0	GENERAL TOLERANCES (UNLESS SPECIFIED)		DIMENSION STYLE MM ONLY		SCALE 3:1	DESIGN UNITS METRIC	THIRD ANGLE PROJECTION			
		4 PLACES ± --- ± --- 3 PLACES ± --- ± --- 2 PLACES ± 0.10 ± --- 1 PLACE ± 0.2 ± --- ANGULAR ± 2 °	mm INCH	DRAWN BY DMAHER	DATE 2007/4/30	TITLE 16CKT PLUG W DC & RF					
DRAFT WHERE APPLICABLE MUST REMAIN WITHIN DIMENSIONS		APPROVED BY EFOLAN		DATE 2007/4/30	MATERIAL NO. 930380001					DOCUMENT NO. SD-93038-001	SHEET NO. 1 OF 3
THIS DRAWING CONTAINS INFORMATION THAT IS PROPRIETARY TO MOLEX INCORPORATED AND SHOULD NOT BE USED WITHOUT WRITTEN PERMISSION											

RECOMMENDED PCB LAYOUT SOLDER TAIL SIDE
1.60mm THK

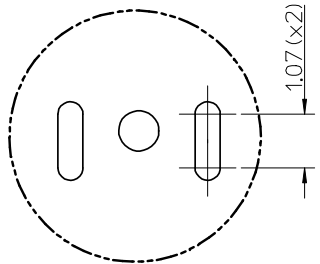

DETAIL 1

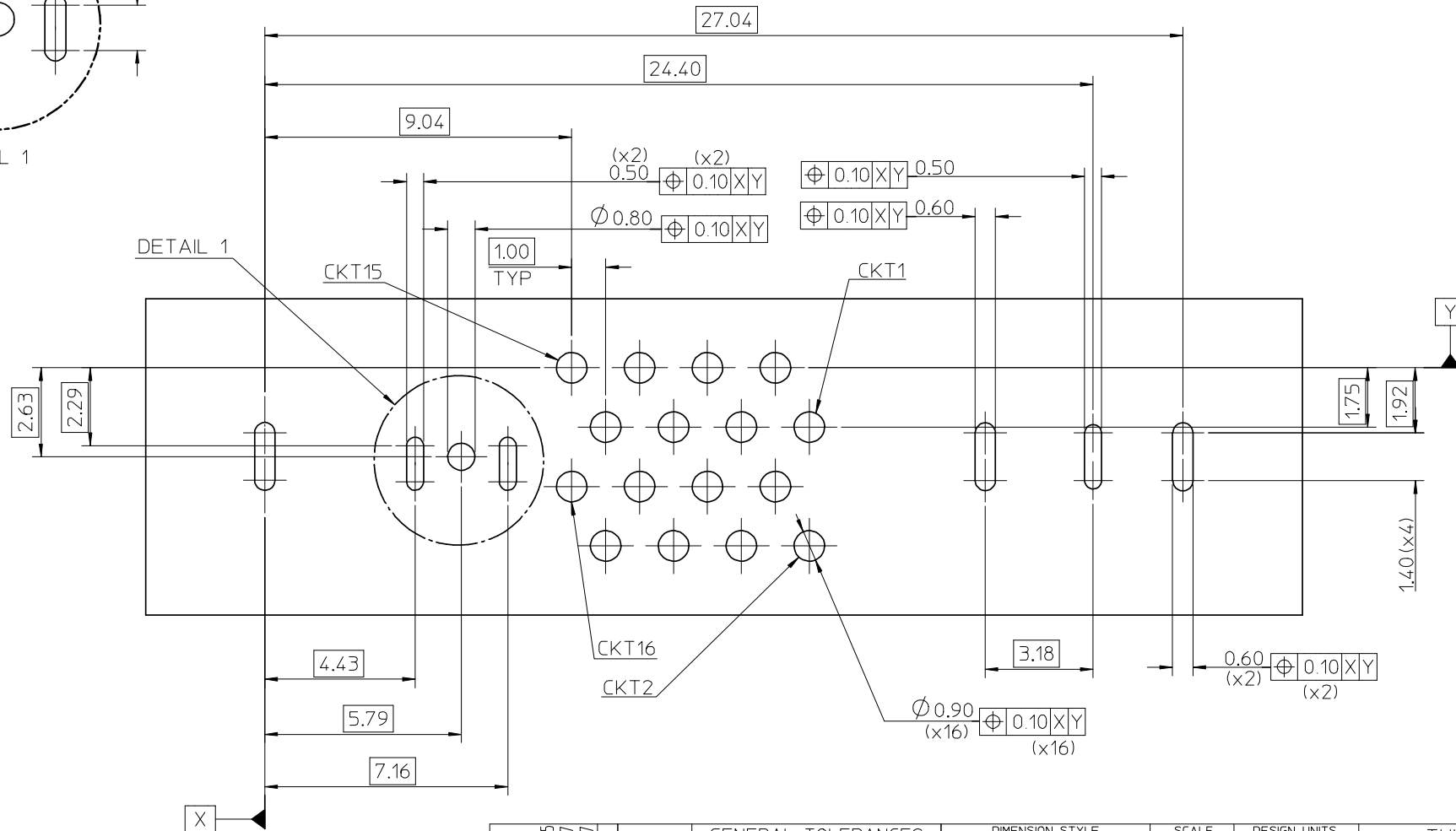

NOTE:
1 ALL SLOTS AND HOLES ARE PLATED THROUGH-HOLES.

SEE SHEET 1 EC NO: E2008-0171 DRWN:DMAHER 2008/03/05 CHKD: 2008/03/07 APPR:EFOLAN 2008/03/07	QUALITY SYMBOLS ▽=0 ▽=0	GENERAL TOLERANCES (UNLESS SPECIFIED) mm INCH 4 PLACES ± --- ± --- 3 PLACES ± --- ± --- 2 PLACES ± 0.10 ± --- 1 PLACE ± 0.2 ± --- ANGULAR ± 2 °	DIMENSION STYLE MM ONLY DRAWN BY: DMAHER CHECKED BY: FDUGGAN APPROVED BY: EFOLAN DATE: 2007/4/30 DATE: 2007/4/30 DATE: 2007/4/30	SCALE 8:1 DESIGN UNITS METRIC THIRD ANGLE PROJECTION	TITLE 16CKT PLUG W DC & RF	
	MATERIAL NO. 930380001	DOCUMENT NO. SD-93038-001	SHEET NO. 2 OF 3	MOLEX INCORPORATED		
	DRAFT WHERE APPLICABLE MUST REMAIN WITHIN DIMENSIONS					
	THIS DRAWING CONTAINS INFORMATION THAT IS PROPRIETARY TO MOLEX INCORPORATED AND SHOULD NOT BE USED WITHOUT WRITTEN PERMISSION					

10 9 8 7 6 5 4 3 2 1

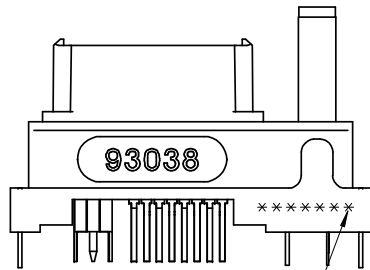
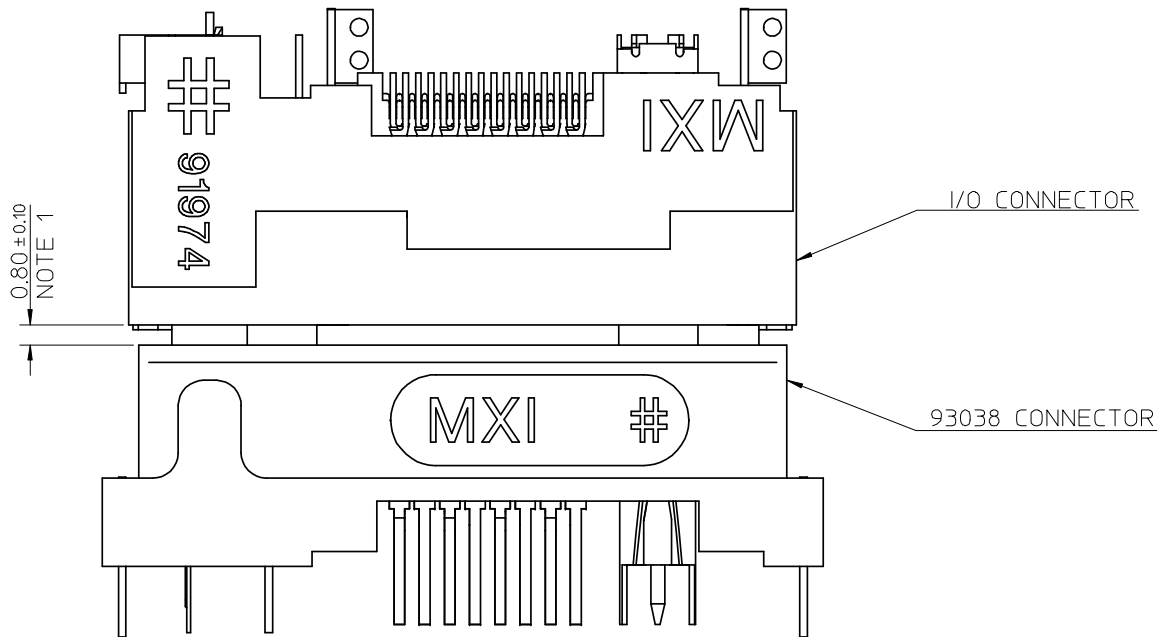

DATE CODE SEE NOTE 7 SHEET 1

MATING I/O & 93038 CONN'S
REFERENCE ONLY

- NOTE:
1. DIMENSION TO ENSURE CORRECT MATING DISTANCE FOR CONNECTOR'S
 2. CONNECTORS MUST MATE ON EACH OTHER IN CUSTOMER APPLICATION



REVISION	DESCRIPTION
A	ORIGINAL RELEASE WITH DATECODE

SEE SHEET 1 EC NO: E2008-0171 DRWN:DMAHER CHKD: APPR:EFOLAN	2008/03/05 2008/03/07	QUALITY SYMBOLS ▽=0 ◻=0	GENERAL TOLERANCES (UNLESS SPECIFIED) <table border="1"> <thead> <tr> <th></th> <th>mm</th> <th>INCH</th> </tr> </thead> <tbody> <tr> <td>4 PLACES</td> <td>± ---</td> <td>± ---</td> </tr> <tr> <td>3 PLACES</td> <td>± ---</td> <td>± ---</td> </tr> <tr> <td>2 PLACES</td> <td>± 0.10</td> <td>± ---</td> </tr> <tr> <td>1 PLACE</td> <td>± 0.2</td> <td>± ---</td> </tr> </tbody> </table>		mm	INCH	4 PLACES	± ---	± ---	3 PLACES	± ---	± ---	2 PLACES	± 0.10	± ---	1 PLACE	± 0.2	± ---	DIMENSION STYLE MM ONLY	SCALE 5:1	DESIGN UNITS METRIC	THIRD ANGLE PROJECTION
		mm	INCH																			
	4 PLACES	± ---	± ---																			
	3 PLACES	± ---	± ---																			
2 PLACES	± 0.10	± ---																				
1 PLACE	± 0.2	± ---																				
DESCRIPTION		DRAWN BY DMAHER	DATE 2007/4/30	TITLE 16CKT PLUG W DC & RF																		
REV		CHECKED BY FDUGGAN	DATE 2007/4/30	MOLEX INCORPORATED																		
MATERIAL NO.		APPROVED BY EFOLAN		DATE 2007/4/30	DOCUMENT NO. SD-93038-001																	

DRAFT WHERE APPLICABLE
MUST REMAIN
WITHIN DIMENSIONS

SIZE A3
THIS DRAWING CONTAINS INFORMATION THAT IS PROPRIETARY TO MOLEX INCORPORATED AND SHOULD NOT BE USED WITHOUT WRITTEN PERMISSION

9 8 7 6 5 4 3 2 1