

DTM12P-DC ✓ ACTIVE

DEUTSCH | DEUTSCH DT, DEUTSCH DTM

TE Internal #: DTM12P-DC

Automotive Connector Caps & Covers, Protective Cover, Gray, PVC, 12 Position, -20 – 212 °F [-29 – 100 °C], DEUTSCH DTM

[View on TE.com >](#)



Connectors > Automotive Connectors > Automotive Connector Accessories > Automotive Connector Caps & Covers



Protection & Strain Relief Accessory Type: **Protective Cover**

Strain Relief: **Without**

Primary Product Color: **Gray**

Primary Product Material: **PVC**

Number of Positions: **12**

Features

Product Type Features

Protection & Strain Relief Accessory Type	Protective Cover
Sealable	No

Configuration Features

Number of Positions	12
---------------------	----

Body Features

Primary Product Color	Gray
Primary Product Material	PVC

Mechanical Attachment

Strain Relief	Without
---------------	---------

Usage Conditions

Compatible With Connector Style	Receptacle
Operating Temperature (Max)	100 °C[212 °F]
Operating Temperature Range	-29 – 100 °C[-20 – 212 °F]

Industry Standards

Degree of Protection	Not Tested
----------------------	------------

Packaging Features

Packaging Method	Box
------------------	-----



Other

Serviceable	Yes
-------------	-----

Product Compliance

[For compliance documentation, visit the product page on TE.com>](#)

EU RoHS Directive 2011/65/EU	Compliant
EU ELV Directive 2000/53/EC	Compliant
China RoHS 2 Directive MIIT Order No 32, 2016	No Restricted Materials Above Threshold
EU REACH Regulation (EC) No. 1907/2006	Current ECHA Candidate List: JAN 2023 (233) Candidate List Declared Against: JAN 2023 (233) Does not contain REACH SVHC
Halogen Content	Not Low Halogen - contains Br or Cl > 900 ppm.
Solder Process Capability	Not reviewed for solder process capability

Product Compliance Disclaimer

This information is provided based on reasonable inquiry of our suppliers and represents our current actual knowledge based on the information they provided. This information is subject to change. The part numbers that TE has identified as EU RoHS compliant have a maximum concentration of 0.1% by weight in homogenous materials for lead, hexavalent chromium, mercury, PBB, PBDE, DBP, BBP, DEHP, DIBP, and 0.01% for cadmium, or qualify for an exemption to these limits as defined in the Annexes of Directive 2011/65/EU (RoHS2). Finished electrical and electronic equipment products will be CE marked as required by Directive 2011/65/EU. Components may not be CE marked. Additionally, the part numbers that TE has identified as EU ELV compliant have a maximum concentration of 0.1% by weight in homogenous materials for lead, hexavalent chromium, and mercury, and 0.01% for cadmium, or qualify for an exemption to these limits as defined in the Annexes of Directive 2000/53/EC (ELV). Regarding the REACH Regulation, the information TE provides on SVHC in articles for this part number is based on the latest European Chemicals Agency (ECHA) 'Guidance on requirements for substances in articles' posted at this URL: <https://echa.europa.eu/guidance-documents/guidance-on-reach>

Compatible Parts

TE Part # CAT-D485-CH8172
DEUTSCH DTM Housings

TE Part # DTM04-12PA-EE04
REC, 12P, BLK, N, HIGH TEMP, A

TE Part # DTM04-12PC-L012
REC, 12P, GRN, N, FLANGE, C

TE Part # DTM04-12PD-L012
REC, 12P, BRN, N, FLANGE, D



TE Part # 2303064-2
REC, 12P, BLK, N, FLANGE, B



TE Part # DTM04-12PC-EE04
REC, 12P, BLK, N, HIGH TEMP, C

Also in the Series | DEUTSCH DT



Automotive Connector Caps & Covers (107)

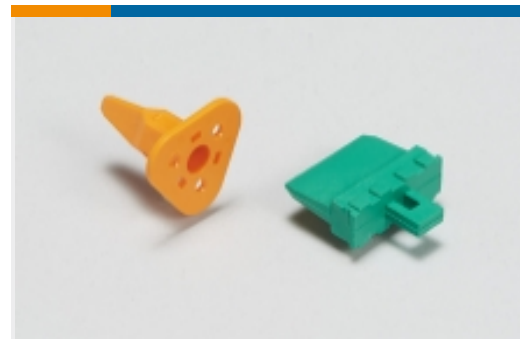

Automotive Connector Locks & Position Assurance(74)



Automotive Housings(618)



Automotive Seals & Cavity Plugs(5)



Insertion & Extraction Tools(3)



Other Automotive Connector Accessories(16)



PCB Headers & Receptacles(102)

Also in the Series | DEUTSCH DTM



Automotive Connector Caps & Covers (41)



Automotive Connector Locks & Position Assurance(17)



Automotive Housings(100)



Insertion & Extraction Tools(2)



PCB Headers & Receptacles(36)

Customers Also Bought



TE Part #HDP26-24-9PE-L017
PLG, 9P, BLK, E, RNG, 4/8/12, P

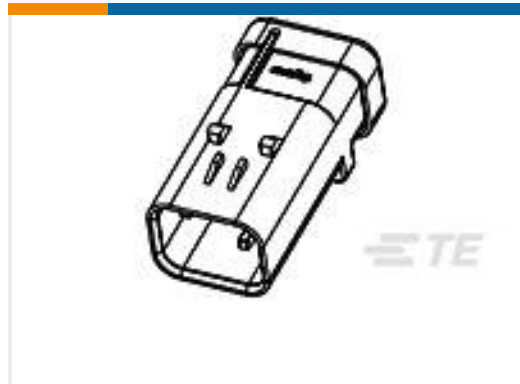

TE Part #776536-2
AS 16, 4P CAP ASSY, RD, KEY 2



TE Part #0528-004-3805
BKSHL, 38P, BLK, PLG, RA



TE Part #2-2112162-1
LEAVYSEAL Housings



TE Part #DTMH06-3SA
PLG, 3P, BLK, N, HI TEMP, A



TE Part #HD10-9-96PE-B025
RECP ASM

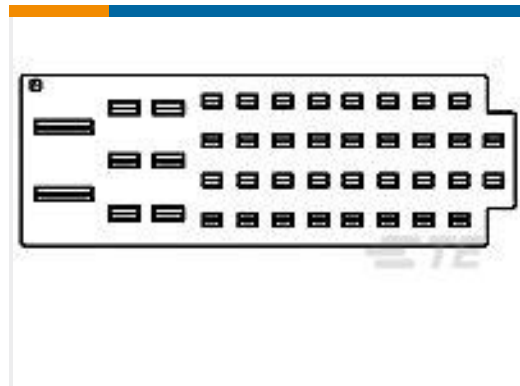

TE Part #967378-1
DICHTUNG



TE Part #DRCP24-86PA
REC, 86P, BLK, 12/20, A



TE Part #DTP2P-BT-BK
BOOT, 2P, REC, ST, BLK

Documents

Product Drawings

[PROTECT CVR, 12P, REC, GRY, DTM](#)

English

CAD Files

[3D PDF](#)

[3D](#)

Customer View Model

[ENG_CVM_CVM_DTM12P-DC_A.2d_dxf.zip](#)



English

Customer View Model

[ENG_CVM_CVM_DTM12P-DC_A.3d_igs.zip](#)

English

Customer View Model

[ENG_CVM_CVM_DTM12P-DC_A.3d_stp.zip](#)

English

By downloading the CAD file I accept and agree to the [Terms and Conditions](#) of use.

Product Specifications

[Application Specification](#)

English