

2

1

PROCESSOR

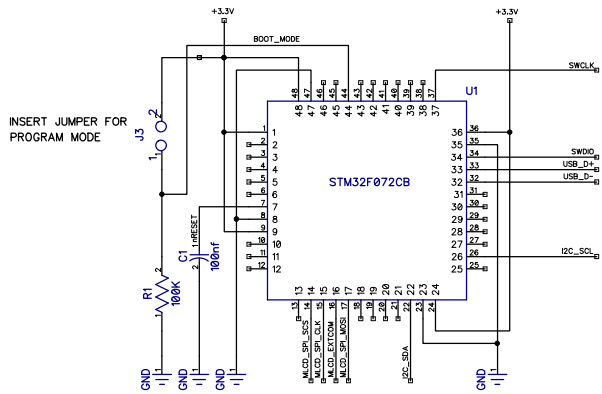

MLCD CONNECTOR 1

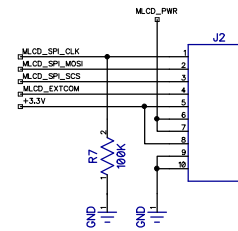

DEBUG CONNECTOR

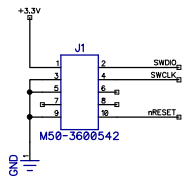

USB DEVICE CONNECTOR

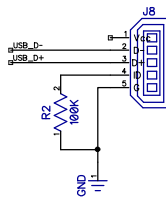

MEMORY LCD POWER SELECT

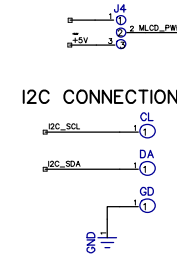

5V PANEL POWER SUPPLY

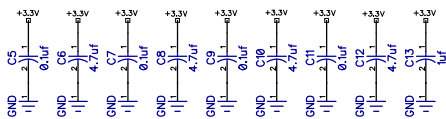
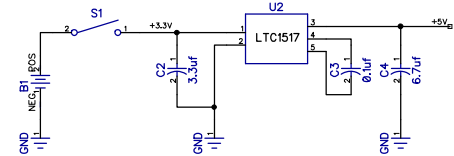

2

1

Sharp Microelectronics		Low Cost MLCD Demo Tool		
		SIZE	FSCM NO.	DWG NO.
SCALE		Sheet 1		REV 5