

LISA2-W-PIN

~35° wide beam. 6.8 mm high variant with location pin installation.

TECHNICAL SPECIFICATIONS:

Dimensions	Ø 10.0 mm
Height	6.8 mm
Fastening	glue, pin
ROHS compliant	yes ⓘ



MATERIAL SPECIFICATIONS:

Component	Type	Material	Colour	Finish
LISA2-W	Single lens	PMMA	clear	
LISA2-HLD-PIN	Holder	PC	black	

ORDERING INFORMATION:

Component		Qty in box	MOQ	MPQ	Box weight (kg)
FP13025_LISA2-W-PIN	Single lens	2000	300	100	1.4
» Box size: 310 x 230 x 60 mm					

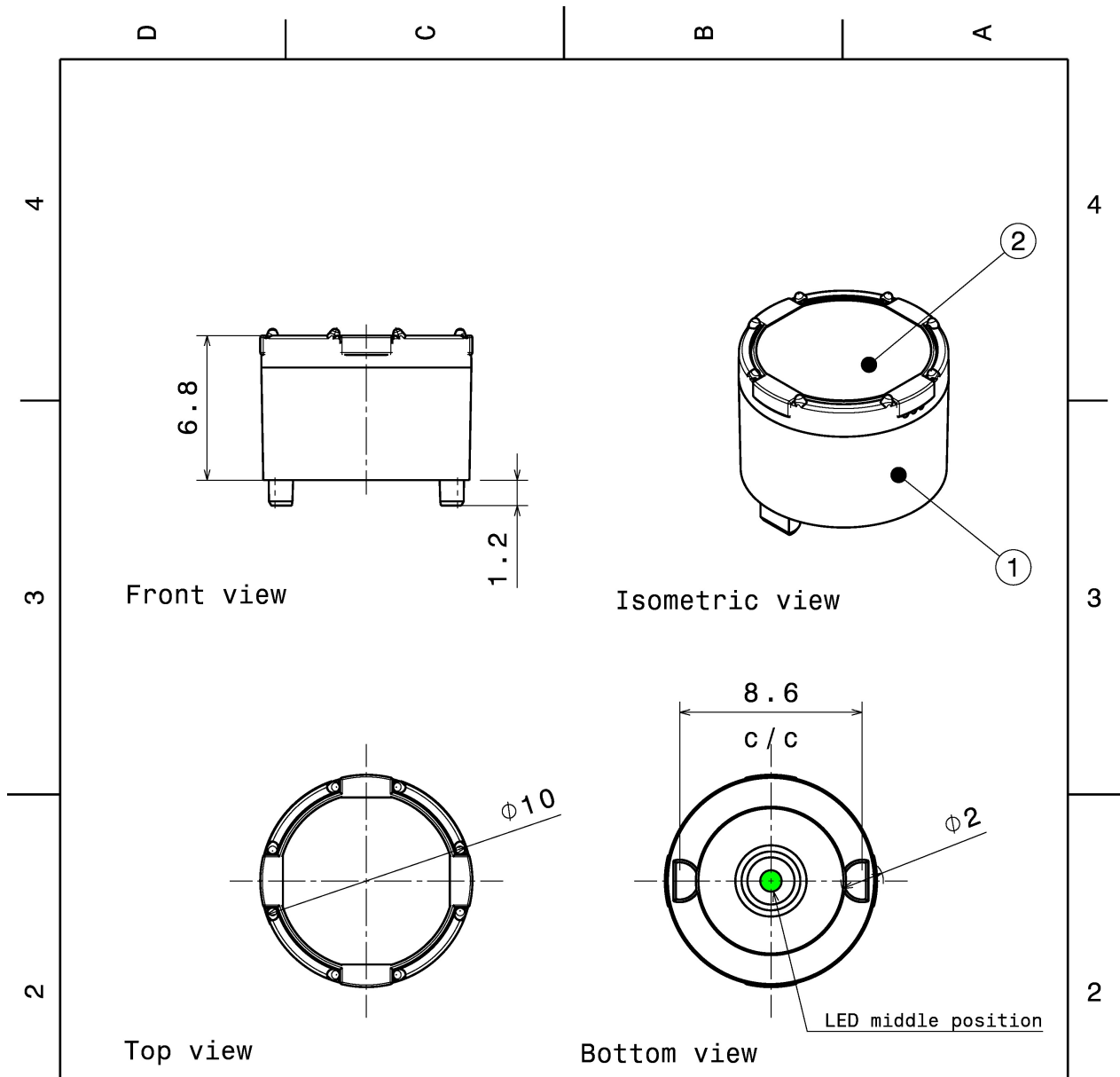

INDEX	PART NO	DESCRIPTION	MATERIAL	COLOUR
1	F10989	LISA2-HLD-PIN	PC	black
2	-	LISA2_lens	PMMA	

Tolerances if not otherwise shown
According to DIN ISO 2768-1
Linear measures:
up to 30mm class M, otherwise class C
According to DIN ISO 2768-2
Form and position: class L

LEDiL Ledil Oy
Salorankatu 10
FIN 24240 SALO
Finland

THIRD ANGLE PROJECTION:

DRAWING TITLE
Lisa2-PIN-XP assembly

This drawing is the property of LEDiL Oy. It may not be reproduced, copied or communicated without a written agreement with LEDiL Oy.

SIZE	PART NUMBER
A4	-

SCALE	4:1	WEIGHT	0,5 g	SHEET	1/1
-------	-----	--------	-------	-------	-----

See also our general installation guide: www.ledil.com/installation_guide

PHOTOMETRIC DATA (MEASURED):

CREE

LED XP-G2
 FWHM / FWTM 36.0° / 55.0°
 Efficiency 88 %
 Peak intensity 2.2 cd/lm
 LEDs/each optic 1
 Light colour White
 Required components:

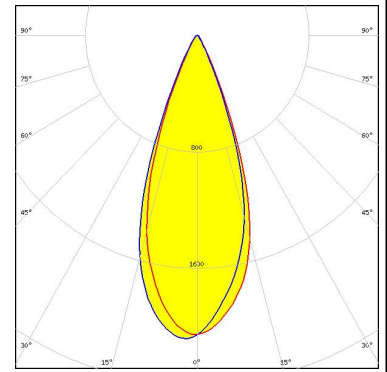

CREE

LED XP-G3
 FWHM / FWTM 39.0° / 63.0°
 Efficiency 84 %
 Peak intensity 1.9 cd/lm
 LEDs/each optic 1
 Light colour White
 Required components:

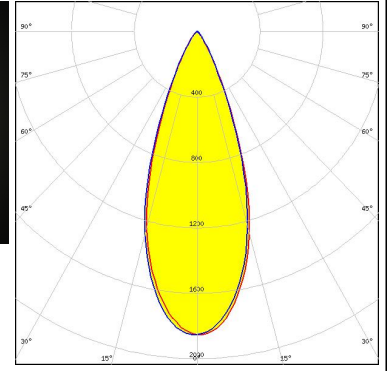
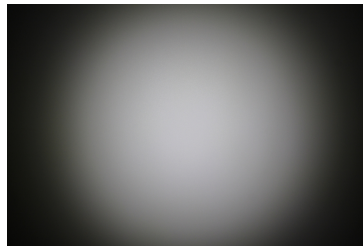

CREE

LED XT-E
 FWHM / FWTM 32.0° / 51.0°
 Efficiency 84 %
 Peak intensity 2.2 cd/lm
 LEDs/each optic 1
 Light colour White
 Required components:

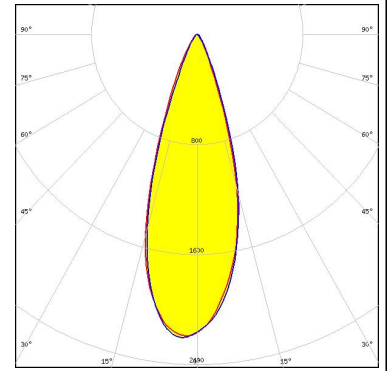





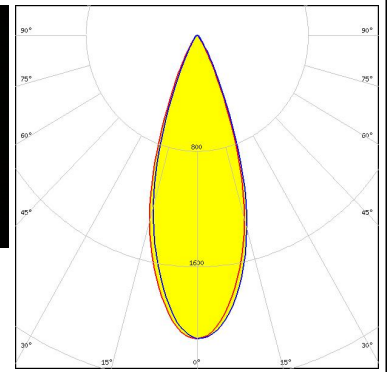
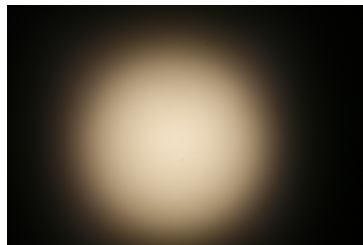

LUMILEDS

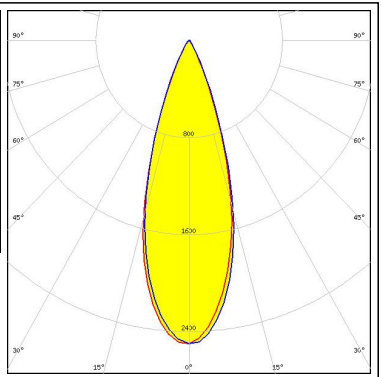
LED LUXEON T
 FWHM / FWTM 36.0° / 58.0°
 Efficiency 86 %
 Peak intensity 2 cd/lm
 LEDs/each optic 1
 Light colour White
 Required components:

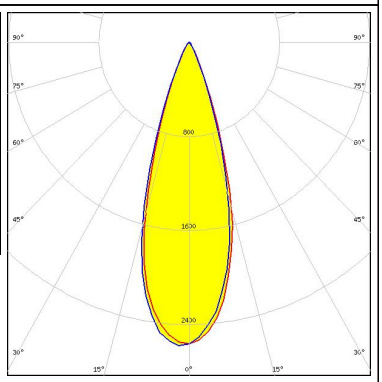

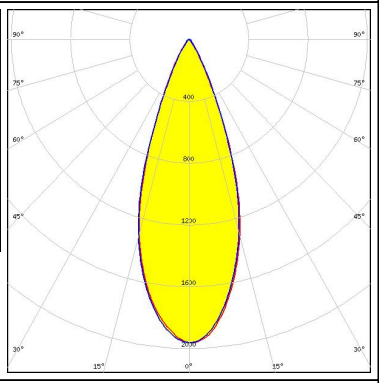
PHOTOMETRIC DATA (MEASURED):

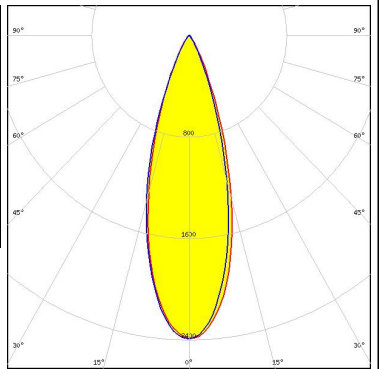
<p>LUMILEDS</p> <p>LED LUXEON TX FWHM / FWTM 34.0° / 55.0° Efficiency 88 % Peak intensity 2.5 cd/lm LEDs/each optic 1 Light colour White Required components:</p>		
<p>NICHIA</p> <p>LED NCSxx19B FWHM / FWTM 34.0° / 53.0° Efficiency 84 % Peak intensity 2.6 cd/lm LEDs/each optic 1 Light colour White Required components:</p>		
<p>NICHIA</p> <p>LED NVSxx19B/NVSxx19C FWHM / FWTM 38.0° / 60.0° Efficiency 86 % Peak intensity 2 cd/lm LEDs/each optic 1 Light colour White Required components:</p>		
<p>OSRAM Opto Semiconductors</p> <p>LED OSLON Square EC FWHM / FWTM 33.0° / 57.0° Efficiency 85 % Peak intensity 2.4 cd/lm LEDs/each optic 1 Light colour White Required components:</p>		

PHOTOMETRIC DATA (MEASURED):

OSRAM

Opto Semiconductors

LED SFH 4715S
FWHM / FWTM 24.0° / 42.0°
Efficiency %
LEDs/each optic 1
Light colour IR
Required components:

OSRAM

Opto Semiconductors

LED SFH 4725S
FWHM / FWTM 24.0° / 42.0°
Efficiency 0 %
LEDs/each optic 1
Light colour White
Required components:

SAMSUNG

LED LH351B
FWHM / FWTM 39.0° / 66.0°
Efficiency 88 %
Peak intensity 1.9 cd/lm
LEDs/each optic 1
Light colour White
Required components:

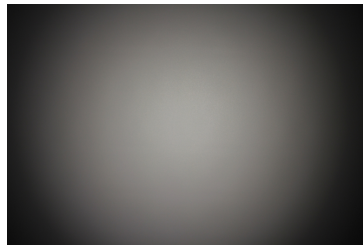

SAMSUNG

LED LH351Z
FWHM / FWTM 38.0° / 60.0°
Efficiency 88 %
Peak intensity 2.1 cd/lm
LEDs/each optic 1
Light colour White
Required components:

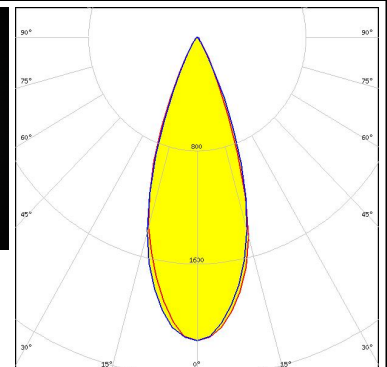
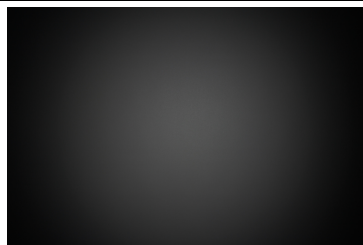

PHOTOMETRIC DATA (SIMULATED):



LED XP-G2 HE
 FWHM / FWTM 42.0° / 67.0°
 Efficiency 88 %
 Peak intensity 1.6 cd/lm
 LEDs/each optic 1
 Light colour White
 Required components:

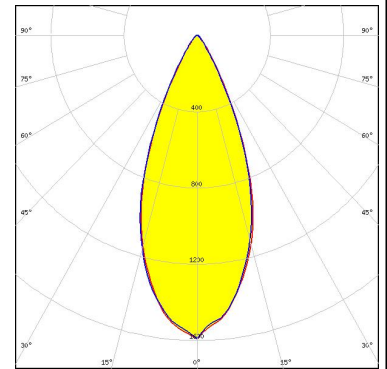

LED LUXEON H50-2
 FWHM / FWTM 30.0° / 52.0°
 Efficiency 89 %
 Peak intensity 2.8 cd/lm
 LEDs/each optic 1
 Light colour White
 Required components:

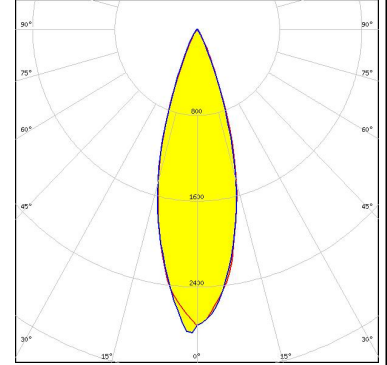

LED LUXEON IR Compact
 FWHM / FWTM 34.0° / 47.0°
 Efficiency 83 %
 LEDs/each optic 1
 Light colour IR
 Required components:



LED SST-20
 FWHM / FWTM 24.0° / 35.0°
 Efficiency 94 %
 Peak intensity 5.4 cd/lm
 LEDs/each optic 1
 Light colour White
 Required components:

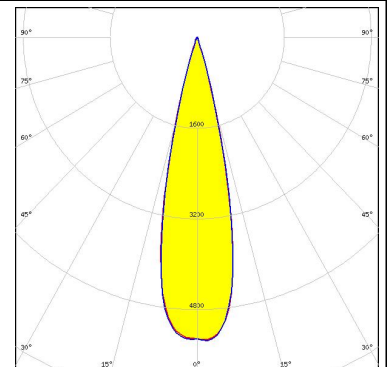

PHOTOMETRIC DATA (SIMULATED):

OSRAM Opto Semiconductors

LED OSLON Black
FWHM / FWTM 22.0° / 34.0°
Efficiency 90 %
Peak intensity 5.7 cd/lm
LEDs/each optic 1
Light colour White
Required components:

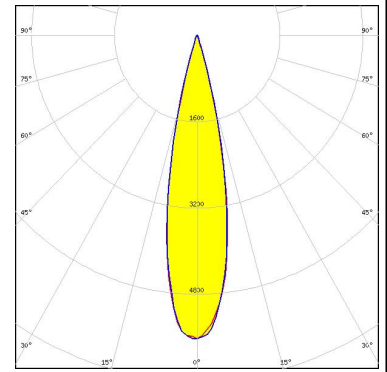

OSRAM Opto Semiconductors

LED SFH 4725AS
FWHM / FWTM 23.0° / 41.0°
Efficiency 89 %
LEDs/each optic 1
Light colour IR
Required components:

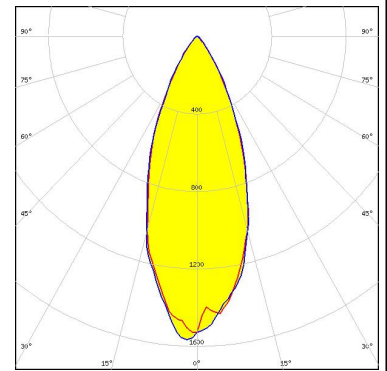

SEOL SEOUL SEMICONDUCTOR

LED Z8Y22P
FWHM / FWTM 38.0° / 70.0°
Efficiency 84 %
Peak intensity 1.6 cd/lm
LEDs/each optic 1
Light colour White
Required components:

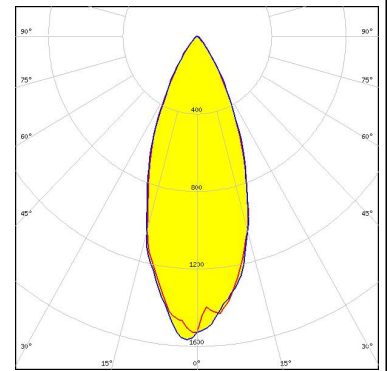

GENERAL INFORMATION:

NOTE: The typical beam angle will be changed by different color, chip size and chip position tolerance. The typical total beam angle is the full angle measured where the luminous intensity is half of the peak value.

MATERIALS:

As part of our continuous research and improvement processes, and to ensure the best possible quality and availability of our products, LEDiL reserves the right to change material grades without notice.

PRODUCT DATA USER AGREEMENT AND DISCLAIMER:

The measured data in the provided downloadable LEDiL Product Datasheets and Mechanical 2D-Drawings is rounded and provided as reference for planning. LEDiL Oy's optical specifications have been verified by conducting performance testing of the products in accordance with the company's quality system. The reported data are averaged results of multiple measurements with typical variation. LEDiL Oy reserves the right to without prior notification make changes and improvements to its products.

LEDiL Oy assumes neither warranty, nor guarantee nor any other liability of any kind for the contents and correctness of the provided data. The provided data has been generated with highest diligence but the provided data may in reality not represent the complete possible variation range of all intrinsic parameters. Therefore, in certain cases a deviation from the provided data could occur.

LEDiL Oy reserves the right to undertake technical changes of its products without further notification which could lead to changes in the provided data. LEDiL Oy assumes no liability of any kind for the possible deviation from any provided data or any other damage resulting from the usage of the provided data.

The user agrees to this disclaimer and user agreement with the download or usage of the provided files.

LEDiL Oy

Joensuunkatu 13
FI-24240 SALO
Finland

LEDiL Inc.

228 West Page Street
Suite D
Sycamore IL 60178
USA

Ledil Optics Technology (Shenzhen) Co., Ltd.

405 , Block B
Casic Motor Building
Shenzhen 518057
P.R.CHINA

Local sales and technical support

[www.ledil.com/
where_to_buy](http://www.ledil.com/where_to_buy)

Shipping locations

Salo, Finland
Hong Kong, China

Distribution Partners

[www.ledil.com/
where_to_buy](http://www.ledil.com/where_to_buy)