

C & D CASES

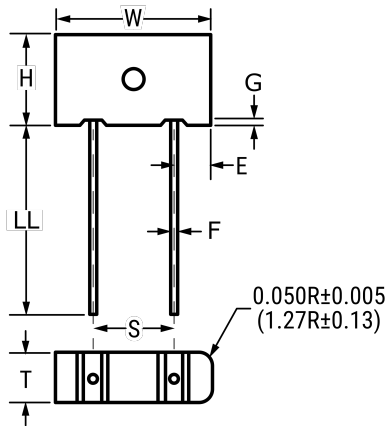

Click [here](#) for the 3D model.

General Information

Series	T330
Dielectric	MnO ₂ Tantalum
Style	Radial Molded
Description	Radial, Solid Tantalum, Molded
Features	Low Leakage
RoHS	No
Prop 65	⚠ WARNING: Cancer and reproductive harm - http://www.p65warnings.ca.gov .
SCIP Number	a3b4e2e1-63ea-439e-a89a-743225502a7d
Termination	Lead (SnPb)
AEC-Q200	No
Construction	Molded
Notes	Longest Lead Is Positive.
Shelf Life	156 Weeks

Dimensions

W	15.24mm +/-0.38mm
H	9.53mm +/-0.38mm
T	4.95mm +/-0.38mm
S	5.08mm +/-0.127mm
LL	12.7mm +/-3.18mm
F	0.64mm +/-0.03mm
E	5.08mm +/-0.25mm
G	0.38mm +/-0.13mm

Specifications

Capacitance	6.8 uF
Capacitance Tolerance	10%
Voltage DC	50 VDC (85C), 33 VDC (125C), 0.5 VDC (125C Reverse)
Temperature Range	-55/+125°C
Dissipation Factor	6%
Resistance	2.5 Ohms (100kHz)
Leakage Current	5 uA

Packaging Specifications

Packaging	Bulk, Bag
Packaging Quantity	100