

SPECIFICATION

- Part No. : **MA760.A.ABIC.003**
- Product Name : Pantheon Antenna 4in1 MA760
Screw-Mount (Permanent Mount)
4G/3G/2G MIMO LTE, GPS/GLONASS/GALILEO, Wi-Fi
2.4/5GHz
- Feature : 2 x Cellular (4G/3G/2G) MIMO Antennas
(698~960MHz, 1710~2170MHz, 2300~2700MHz,
2900-3500MHz)
1 x GPS/GLONASS/GALILEO 1575.42~1602MHz Active
Antenna
1 x Wi-Fi 2.4GHz / 5GHz Antennas
IP67 Waterproof
High Efficiency / Peak Gain Outdoor Antenna
RoHS Compliant



1. Introduction

The MA760 4in1 antenna is an omnidirectional heavy-duty, fully IP67 waterproof external M2M antenna for use in telematics, transportation and remote monitoring applications. It is the first antenna on the market to combine 4in1 that includes two LTE MIMO elements, one 2.4GHz/5GHz antenna and GPS/GLONASS/GALILEO in the highest efficiency and peak gain possible. This unique antenna delivers powerful MIMO antenna technology for LTE while also fully compatible with legacy 3G and 2G networks worldwide, plus GPS/GLONASS/GALILEO for next generation high bandwidth telematics systems.

New fleet management and mobile and fixed video technology allows for real-time video uplink and downlink. High efficiency, high gain MIMO antennas are necessary to achieve the high signal to noise ratio and throughput required to solve these challenges. The Pantheon MA760 consists of two Cellular 4G/3G/2G MIMO elements working at 698-960MHz, 1710-2170MHz, 2300~2700MHz, 2900-3500MHz which means it can work worldwide, one high gain GPS/GLONASS/GALILEO antenna at 1575.42 MHz and one dual-band Wi-Fi 2.4GHz/5GHz antenna.

The 4 high efficiency and gain antennas are mounted in an extremely robust IP67 direct mount antenna package with excellent isolation (20dB+). The antenna has its own ground-plane and can radiate on any mounting environment like metal or plastic without affecting performance.

The GPS/GLONASS/GALILEO

antenna has a front end SAW filter configuration. The front-end SAW increases protection against out of band LNA burn out.

The Dual-band Wi-Fi antenna has stable efficiency and peak gain on both bands even at 3 meters cable length where other antennas would have marked reduced performance.

The connectors and cable lengths are customizable. The housing is also available in White. Recommended maximum cable length is 3 meters.

2. Specification Table

4G/3G/2G MIMO ANTENNA				
Frequency (Mhz)	698~960	1710~2170	2300~2700	2900-3500
VSWR	3 Max			
Polarization	Vertical			
Impedance	50 Ω			

2.4GHz / 5GHz ANTENNA				
Frequency (GHz)	2.4 ~ 2.5	4.7 ~ 5.0	5.0 ~ 5.4	5.4 ~ 5.9
Peak Gain (dBi)	2.1	2.9	3.8	2.8
Average Gain (dBi)	-2.3	-3.6	-3.3	-3.8
Efficiency	60%	44%	46%	42%
VSWR	<=1.7:1			
Impedance	50Ω			
Polarization	Linear			
Radiation Pattern	Omnidirectional			

GPS-GLONASS-GALILEO						
Centre Frequency	1575.42MHz / 1602MHz					
Bandwidth	10MHz					
Radiation Efficiency	50(without cable)					
Passive Gain @ Zenith	4.0 typ(with $\psi=140$ mm ground)					
VSWR	2					
Impedance	50Ω					
DC Power Input Range	3 ~ 5V					
DC input	3.3V		4.0V		5.5V	
MHz	1575.4	1602	1575.4	1602	1575.4	1602
VSWR	2	2	2	2	2	2
LNA Gain	29.2	29	31	31	32.3	32
Noise Figure	3.1	3.1	3.2	3.2	3.4	3.4
Power Consumption	7.5	7.5	9.4	9.4	15	15
Band Attenuation	1520MHz: -20dB 1642MHz: -20dB		1520MHz: -20dB 1642MHz: -20dB		1520MHz: -20dB 1642MHz: -20dB	
Cable	3m RG-174 standard, fully customizable					
Connector	SMA(M) standard, fully customizable					

MECHANICAL	
Antenna Dimensions	H: 85.7mm, D: 145.6mm
Casing	Wonderloy PC-540 PC/ABS Alloy
Waterproof	IP67
4G/3G/2G MIMO 1	3M Low Loss CFD-200 SMA(M)
4G/3G/2G MIMO 2	3M Low Loss CFD-200 SMA(M)
2.4/5GHz MIMO 1	3M Low Loss CFD-200 RP-SMA(M)
GPS/GLONASS/GALILEO	3M RG-174 SMA(M)
ENVIRONMENTAL	
Operation Temperature	-40°C to 85°C
Storage Temperature	-40°C to 90°C
Humidity	Non-condensing 65°C 95% RH

* all measurements were conducted with 3 meters low loss CFD200 cable

LTE BANDS				
Band Number	LTE / LTE-Advanced / WCDMA / HSPA / HSPA+ / TD-SCDMA			
	Uplink	Downlink	MIMO 1	MIMO 2
1	UL: 1920 to 1980	DL: 2110 to 2170	✓	✓
2	UL: 1850 to 1910	DL: 1930 to 1990	✓	✓
3	UL: 1710 to 1785	DL: 1805 to 1880	✓	✓
4	UL: 1710 to 1755	DL: 2110 to 2155	✓	✓
5	UL: 824 to 849	DL: 869 to 894	✓	✗
7	UL: 2500 to 2570	DL: 2620 to 2690	✓	✓
8	UL: 880 to 915	DL: 925 to 960	✓	✗
9	UL: 1749.9 to 1784.9	DL: 1844.9 to 1879.9	✓	✓
11	UL: 1427.9 to 1447.9	DL: 1475.9 to 1495.9	✗	✗
12	UL: 699 to 716	DL: 729 to 746	✓	✓
13	UL: 777 to 787	DL: 746 to 756	✓	✓
14	UL: 788 to 798	DL: 758 to 768	✓	✓
17	UL: 704 to 716	DL: 734 to 746 (LTE only)	✓	✓
18	UL: 815 to 830	DL: 860 to 875 (LTE only)	✓	✗
19	UL: 830 to 845	DL: 875 to 890	✓	✗
20	UL: 832 to 862	DL: 791 to 821	✓	✗
21	UL: 1447.9 to 1462.9	DL: 1495.9 to 1510.9	✗	✗
22	UL: 3410 to 3490	DL: 3510 to 3590	✓	✗
23	UL: 2000 to 2020	DL: 2180 to 2200 (LTE only)	✓	✓
24	UL: 1625.5 to 1660.5	DL: 1525 to 1559 (LTE only)	✓	✓
25	UL: 1850 to 1915	DL: 1930 to 1995	✓	✓
26	UL: 814 to 849	DL: 859 to 894	✓	✗
27	UL: 807 to 824	DL: 852 to 869 (LTE only)	✓	✗
28	UL: 703 to 748	DL: 758 to 803 (LTE only)	✓	✗
29	UL: -	DL: 717 to 728 (LTE only)	✓	✓
30	UL: 2305 to 2315	DL: 2350 to 2360 (LTE only)	✓	✓
31	UL: 452.5 to 457.5	DL: 462.5 to 467.5 (LTE only)	✗	✗
32	UL: -	DL: 1452 - 1496	✗	✗
35		1850 to 1910	✓	✓
38		2570 to 2620	✓	✓
39		1880 to 1920	✓	✓
40		2300 to 2400	✓	✓
41		2496 to 2690	✓	✓
42		3400 to 3600	✓	✗
43		3600 to 3800	✗	✗

*Covered bands represent an efficiency greater than 20%

3. LTE MIMO

3.1. LTE MIMO 1 and LTE MIMO 2 Specification

3.1.1. Return Loss

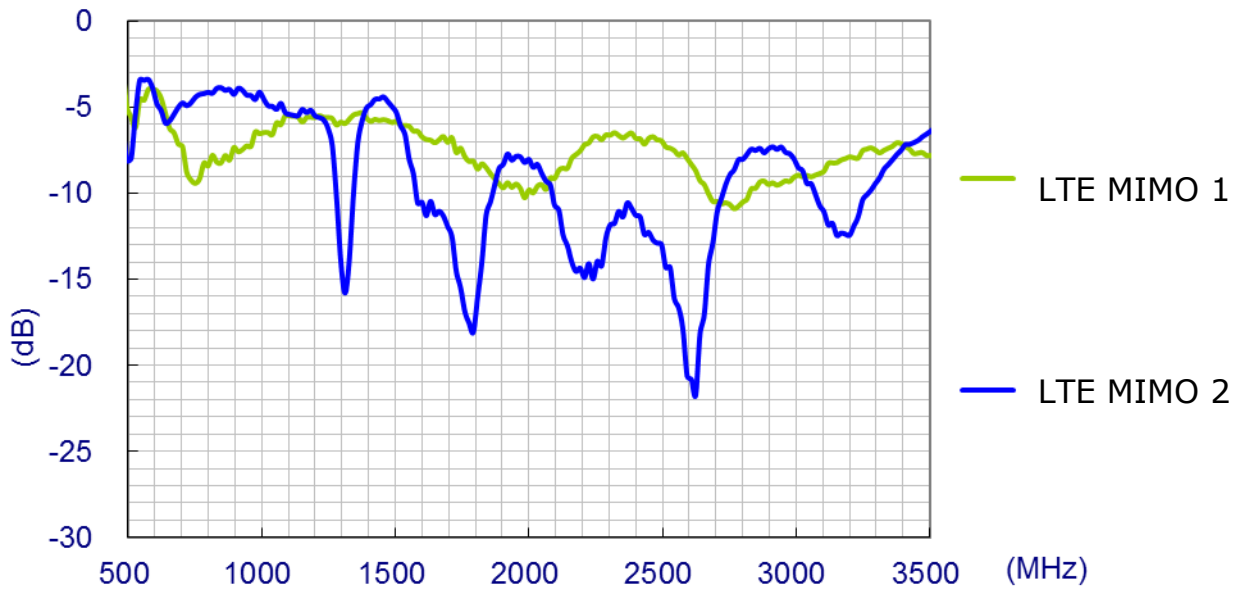

3.1.2. Maximum Gain

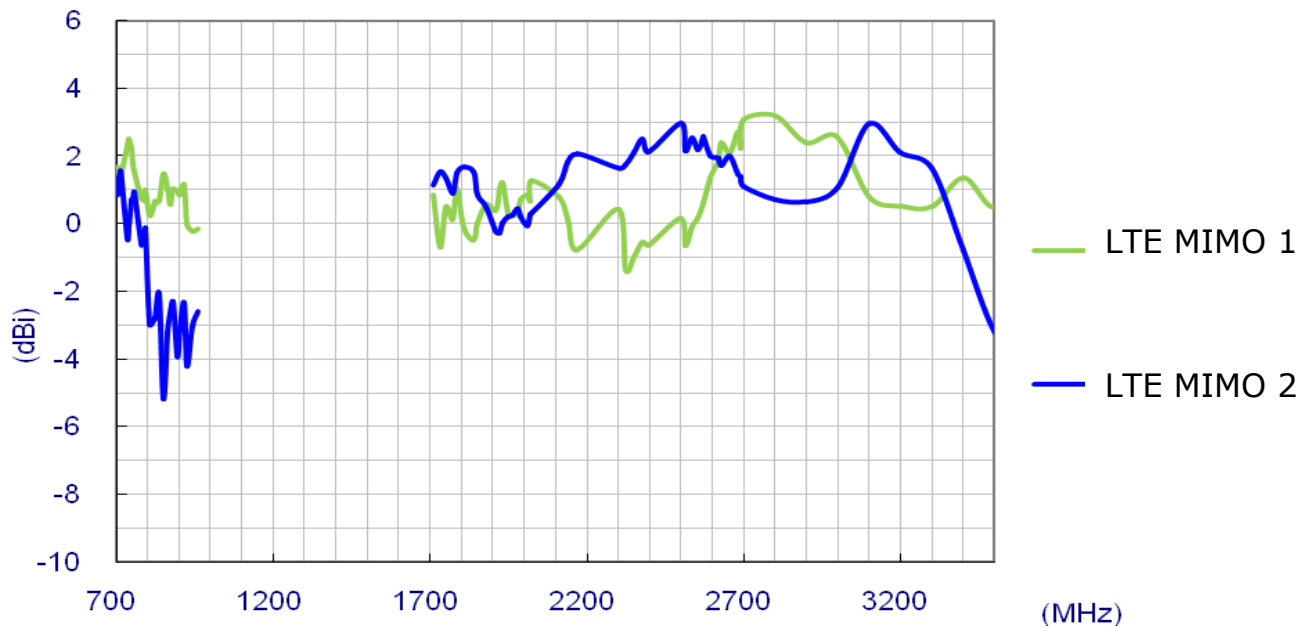

3.1.3. Average Gain

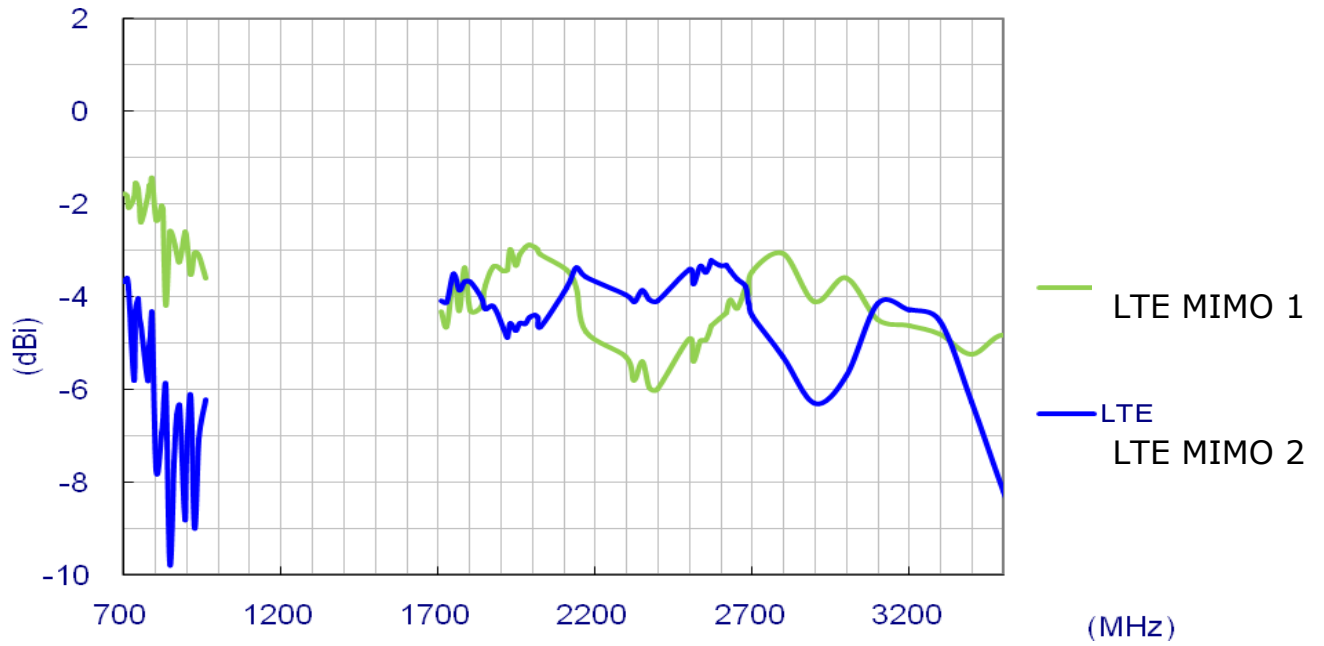

3.1.4. Efficiency

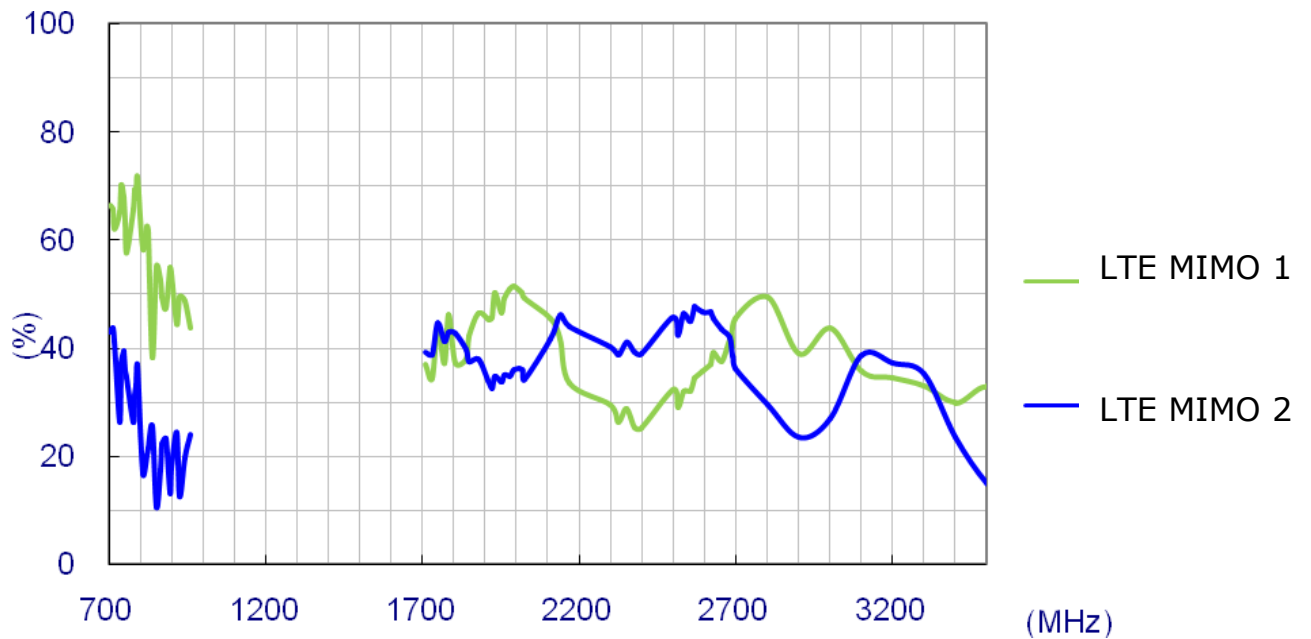

3.2. Radiation Patterns



3.2.1. LTE MIMO 1 Radiation Pattern

XY Plane

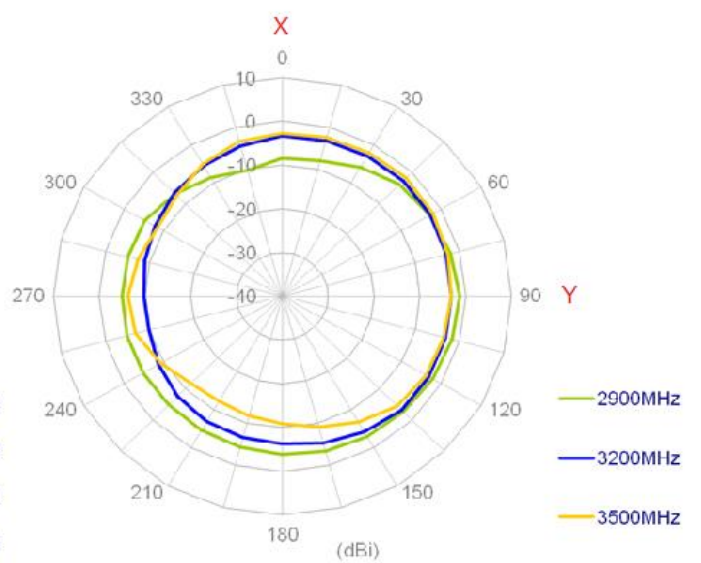
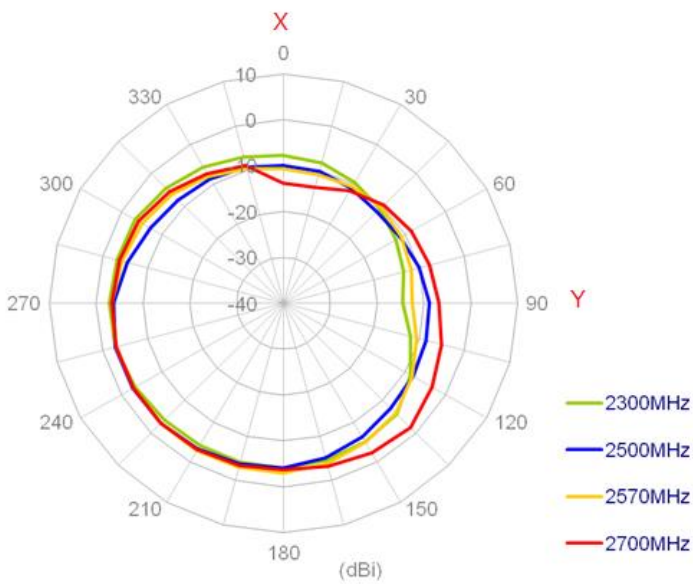
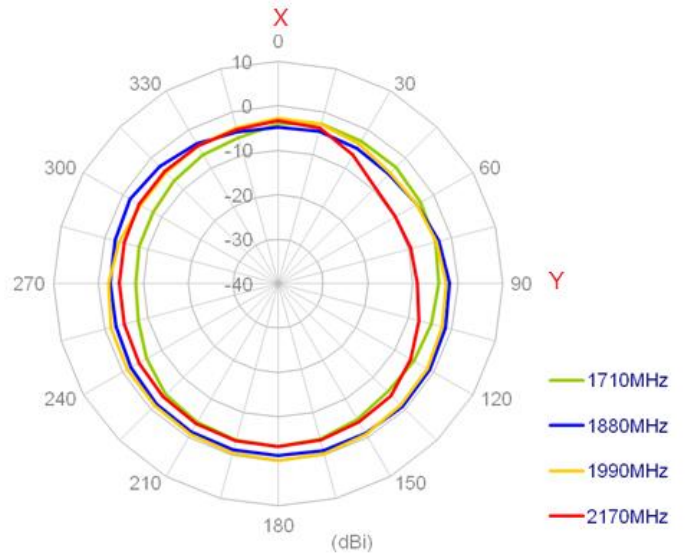
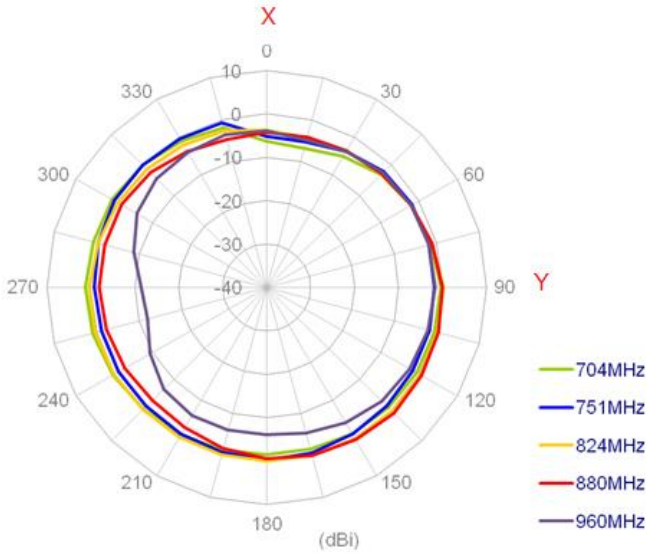

XZ Plane

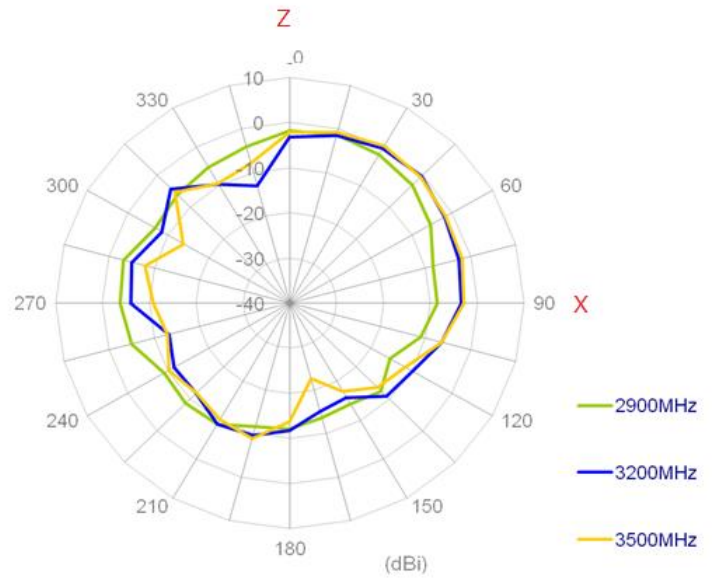
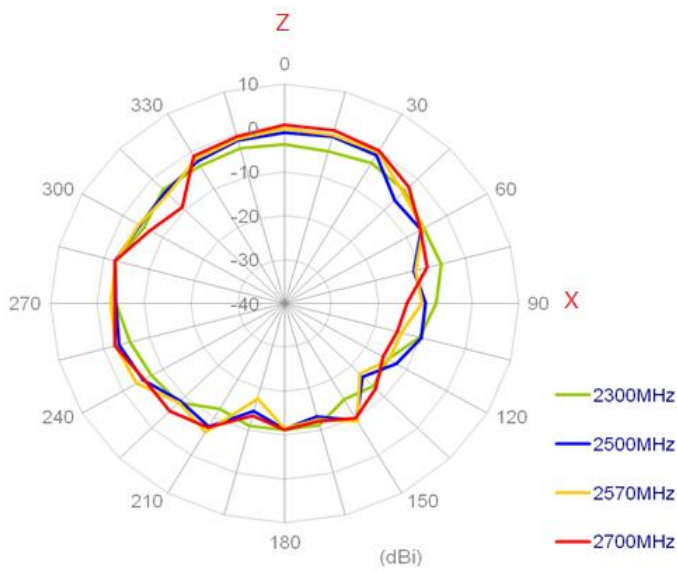
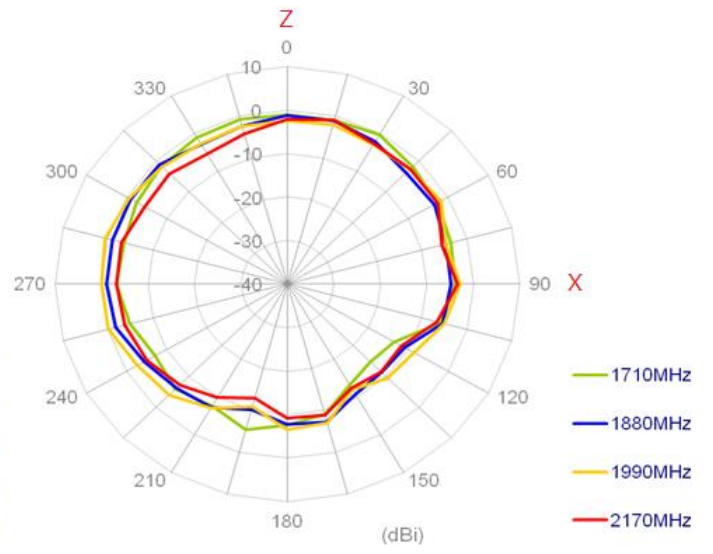
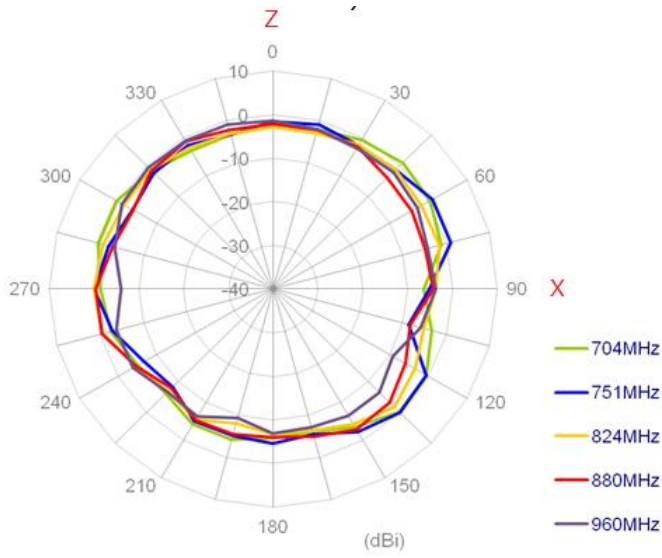

3.2.2. LTE MIMO 2 Radiation Pattern

XY Plane

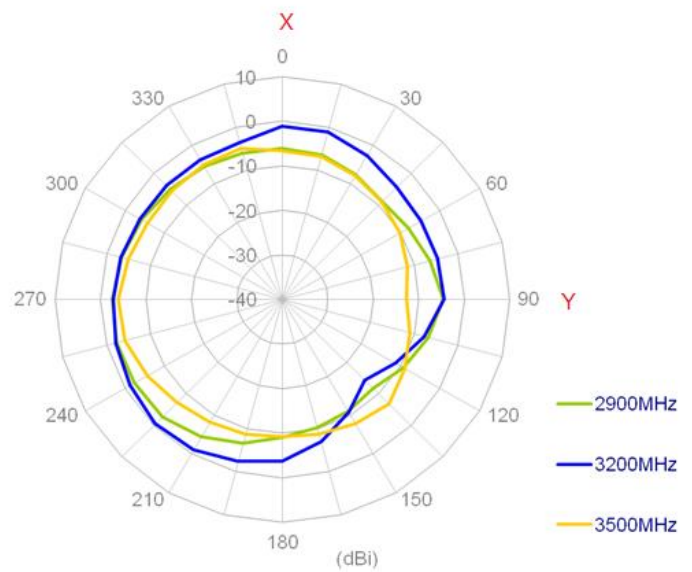
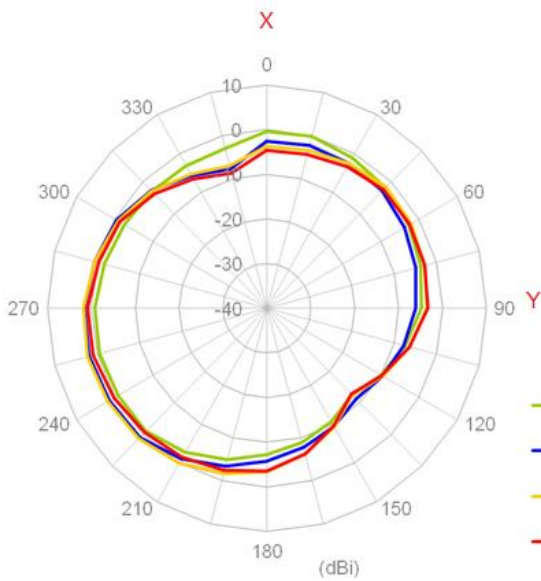
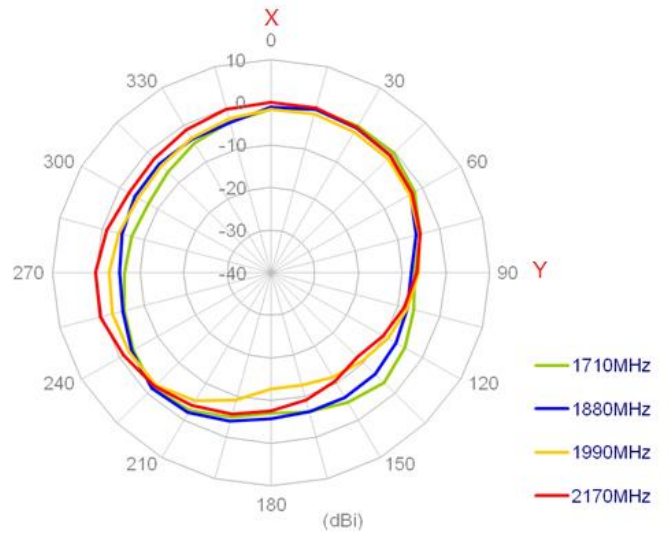
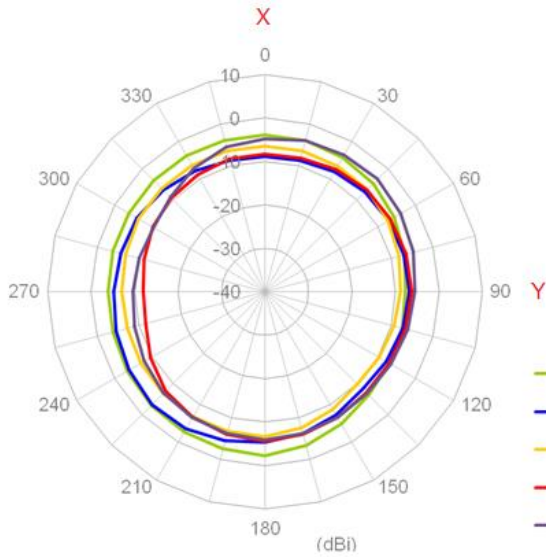

XZ Plane

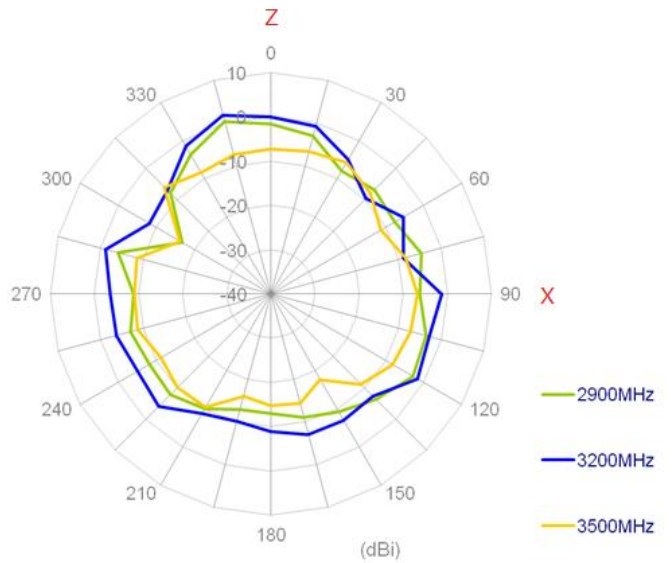
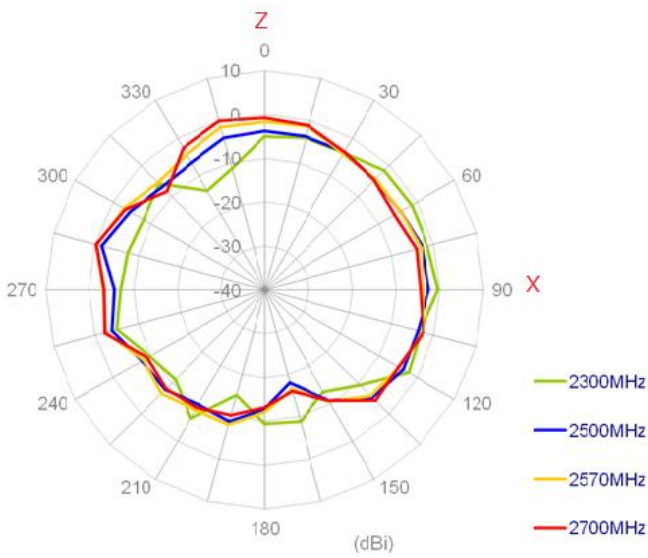
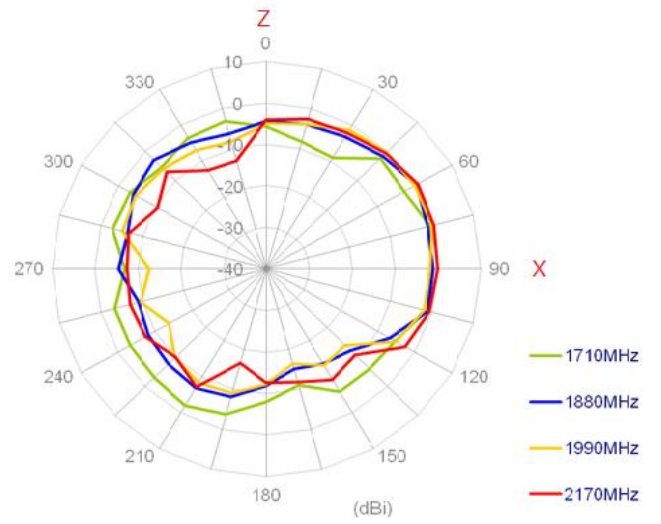
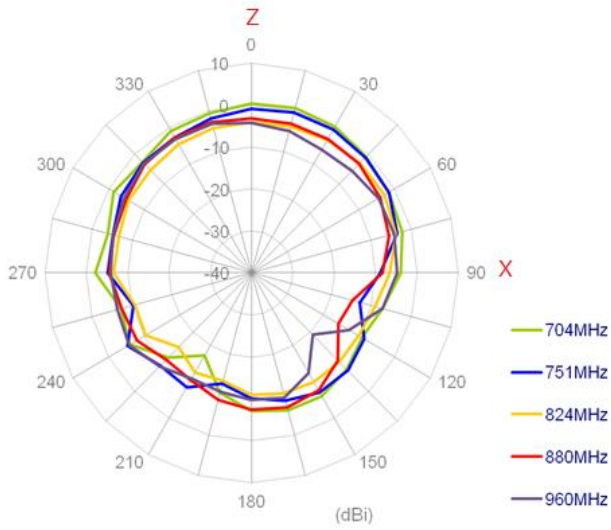

4. Wi-Fi 2.4/ 5GHz

4.1. Return Loss

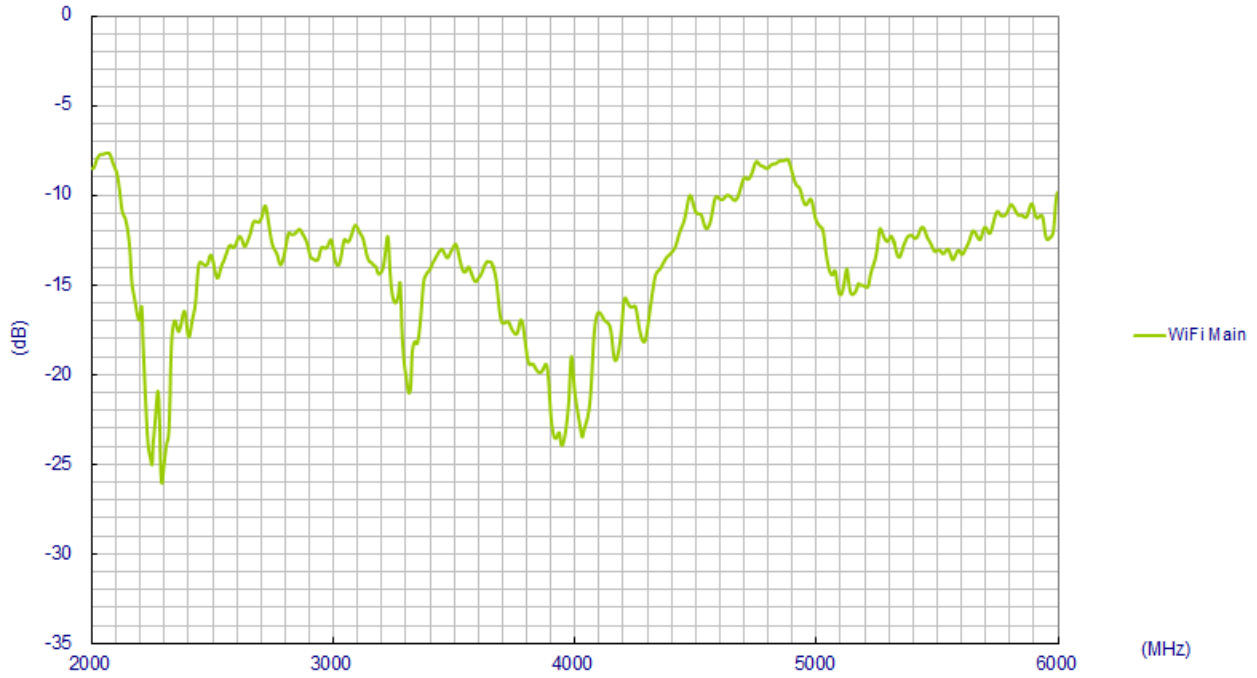

4.2. Maximum Gain

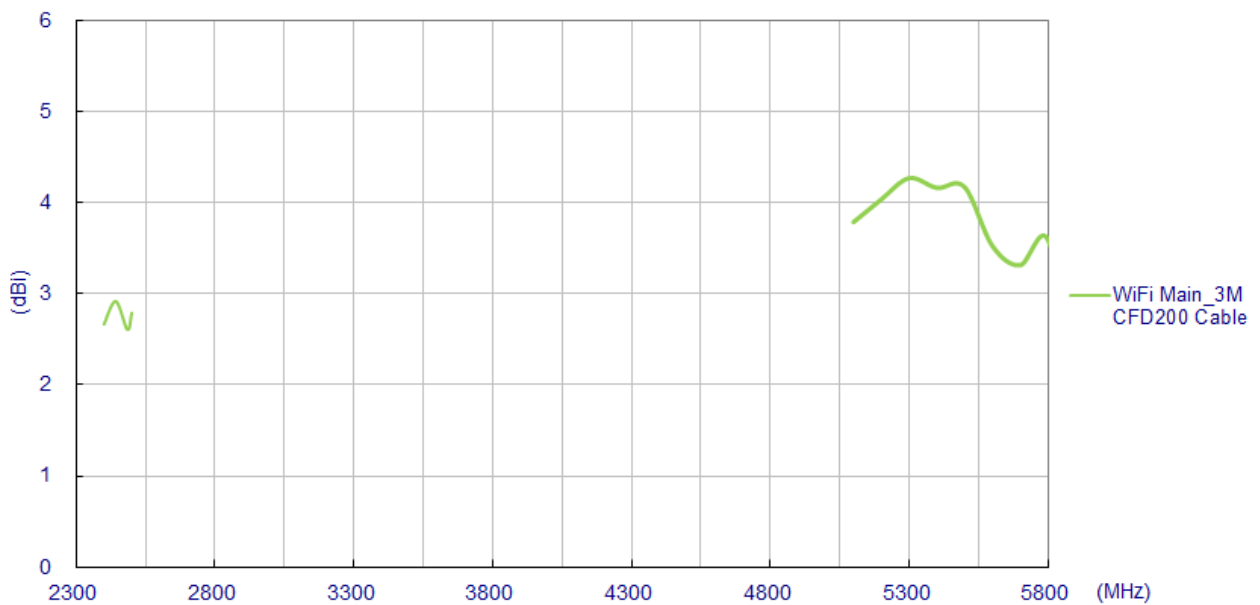

4.3. Average Gain

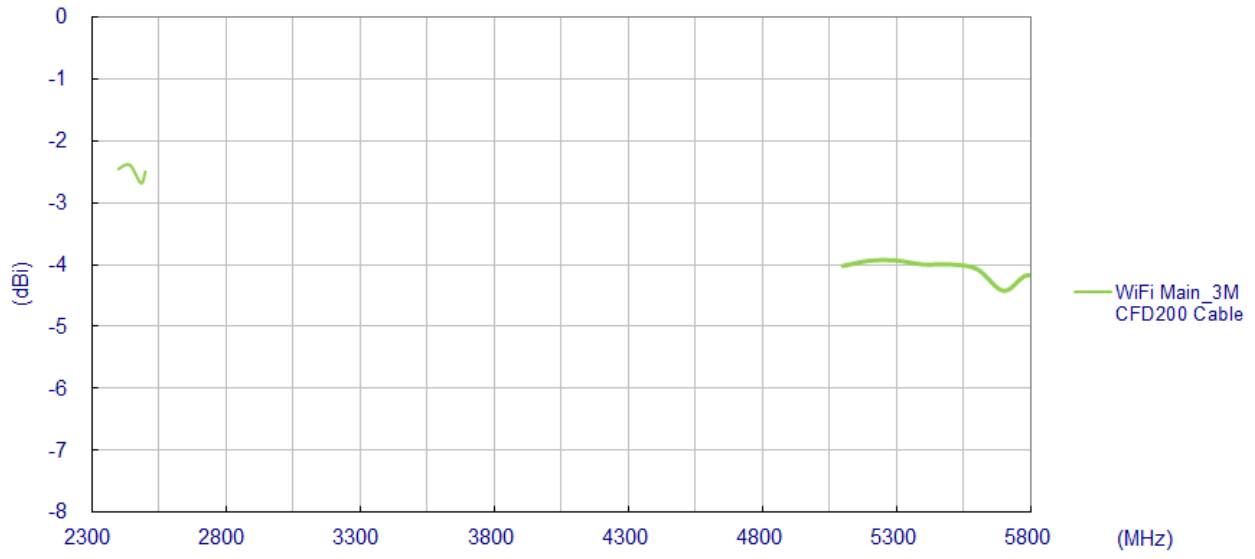

4.4. Efficiency

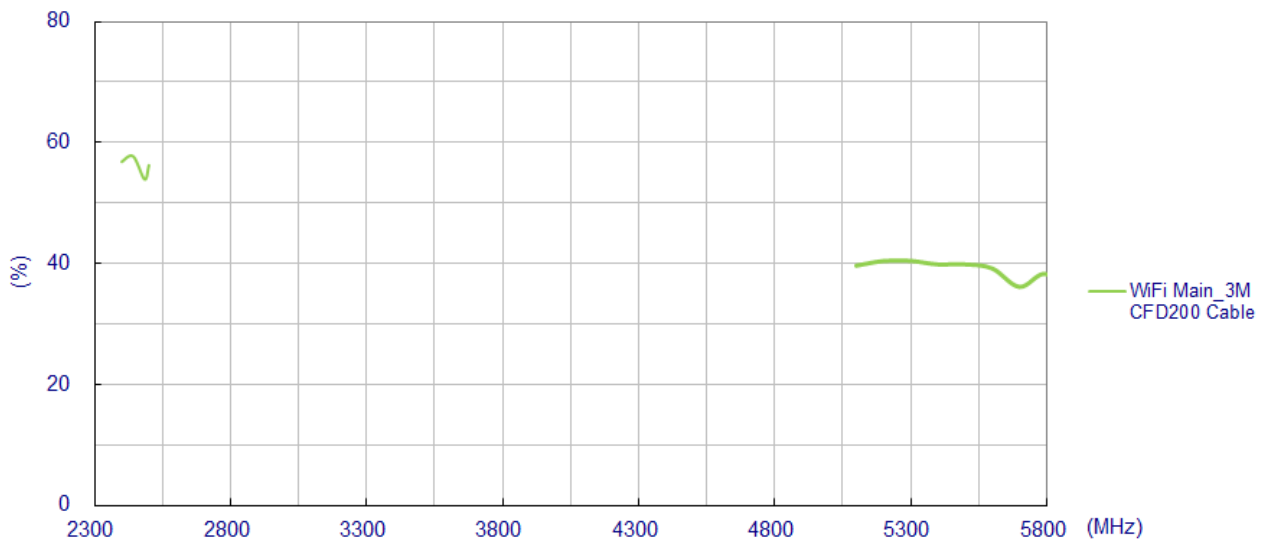

4.5. Radiation Patterns



XY plane

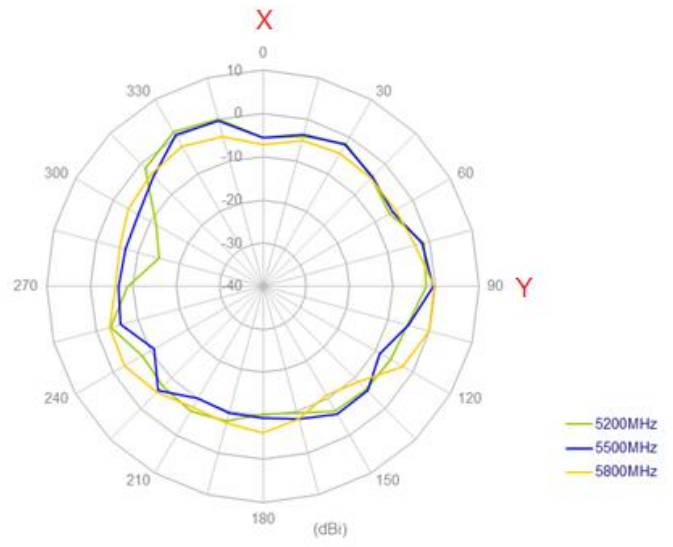
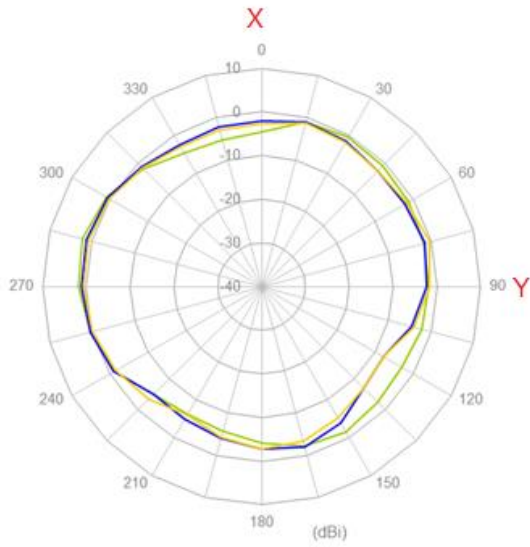

XZ plane

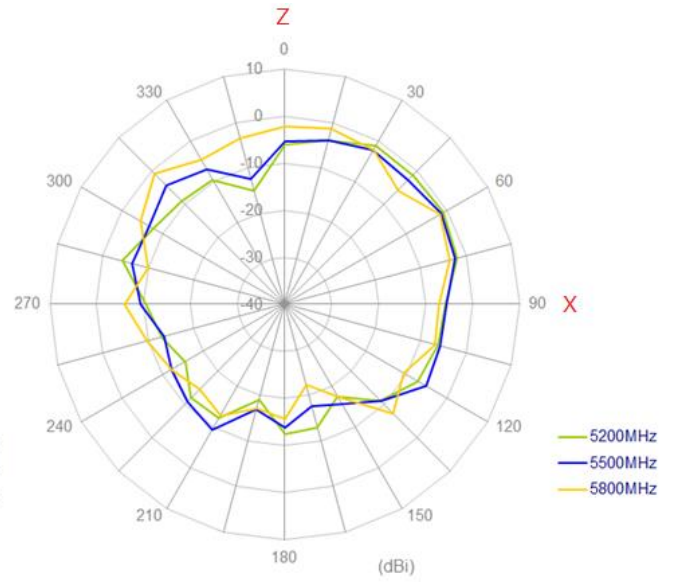
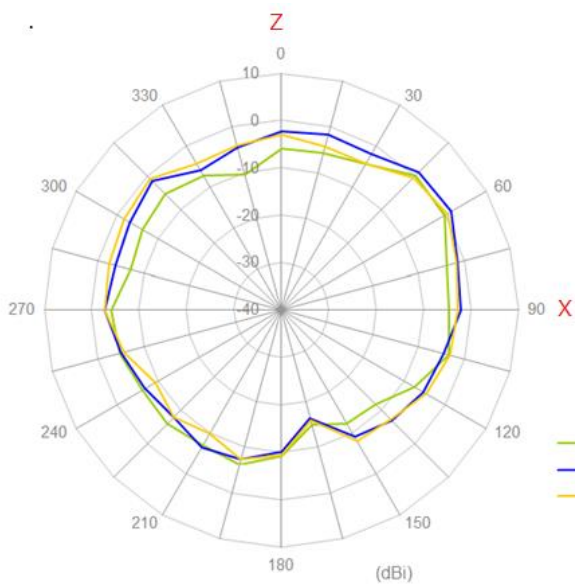

5. GPS/GLONASS/GALILEO

5.1. Block diagram

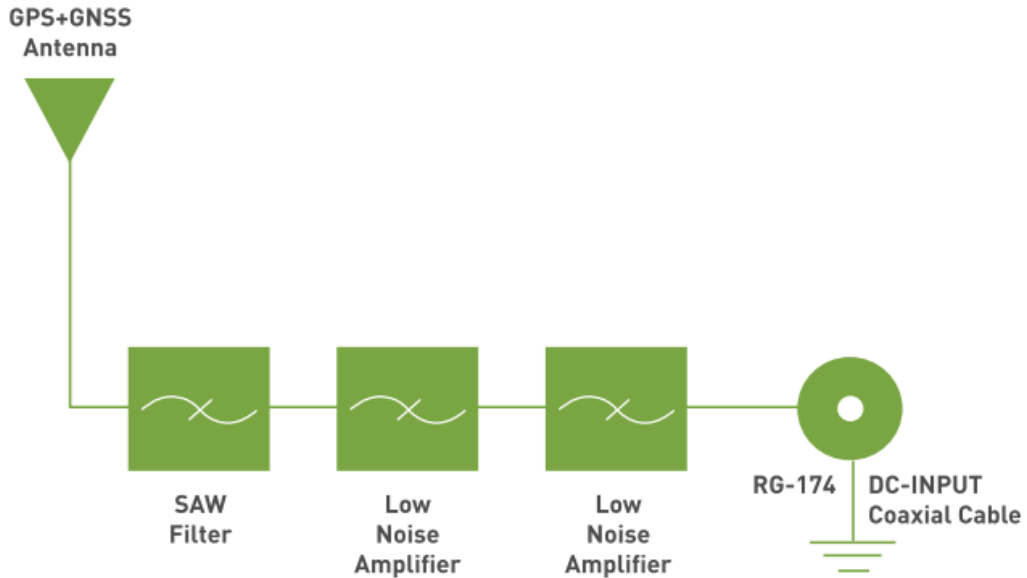

5.2. Return Loss

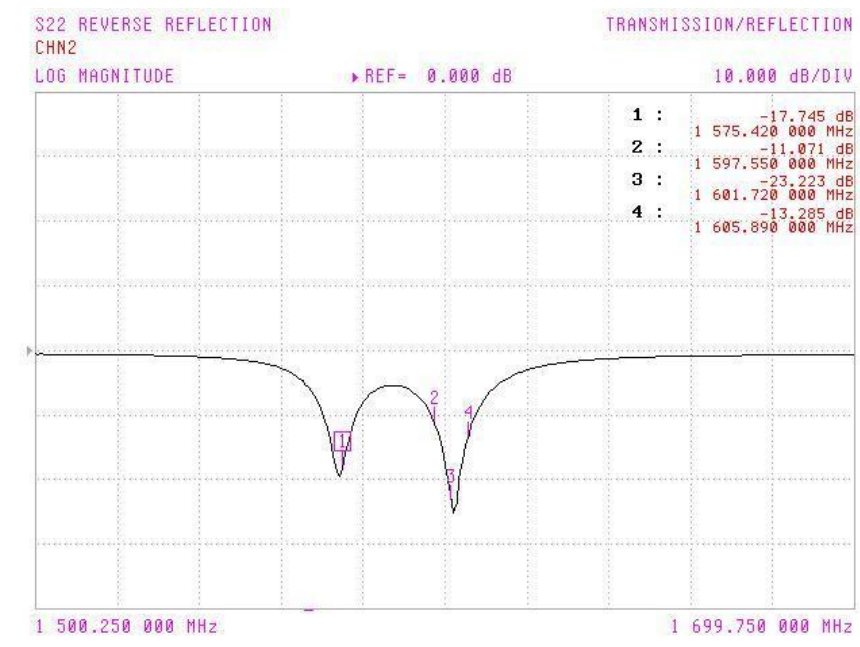

5.3. Radiation pattern

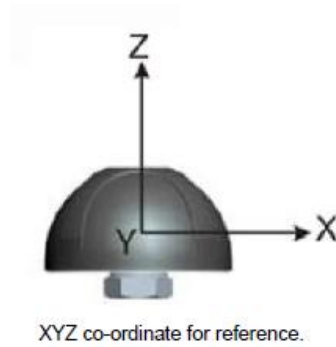

XYZ co-ordinate for reference.

5.3.1. XZ Plane Free space @1575.42MHz

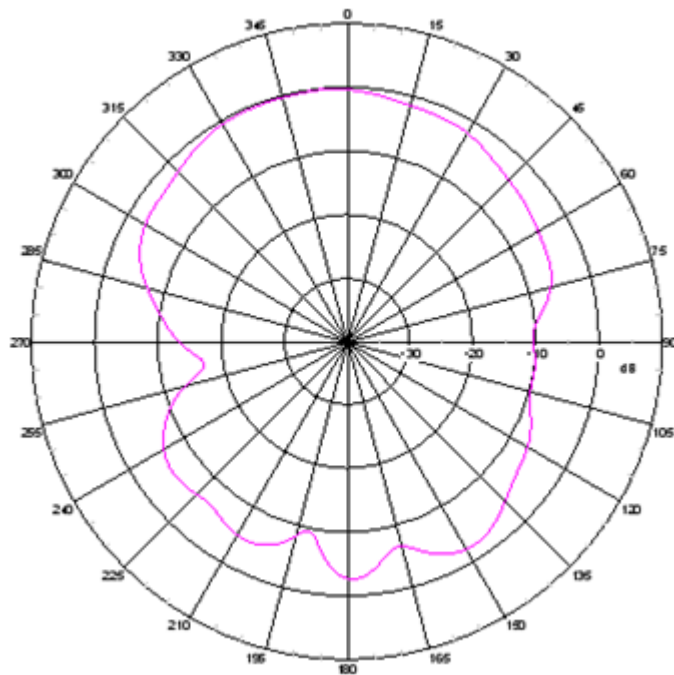

5.3.2. YZ Plane Free Space @1575.42MHz

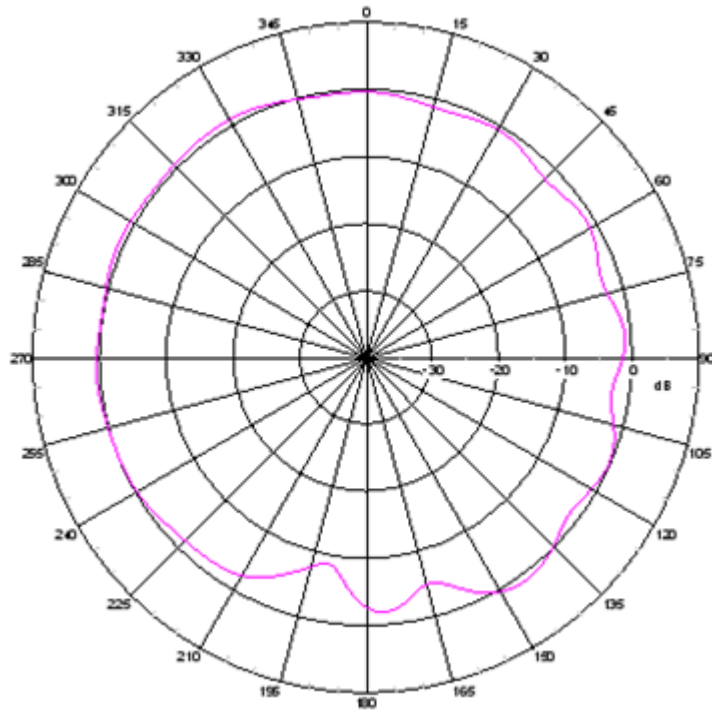

5.3.3. XZ Plane Free space @1602MHz

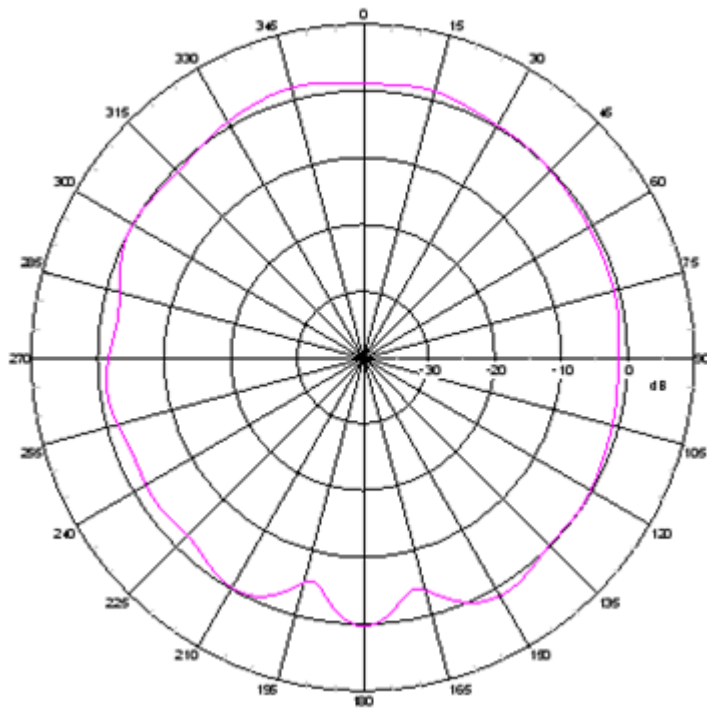

5.3.4. YZ Plane free space @1602MHz

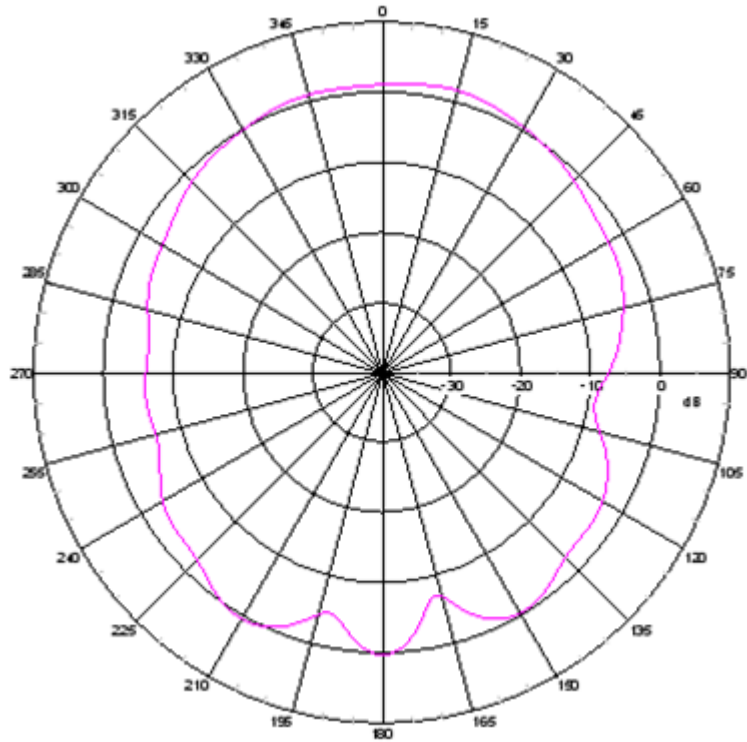

5.4. GPS/GLONASS/GALILEO LNA

S21 Forward Transmission

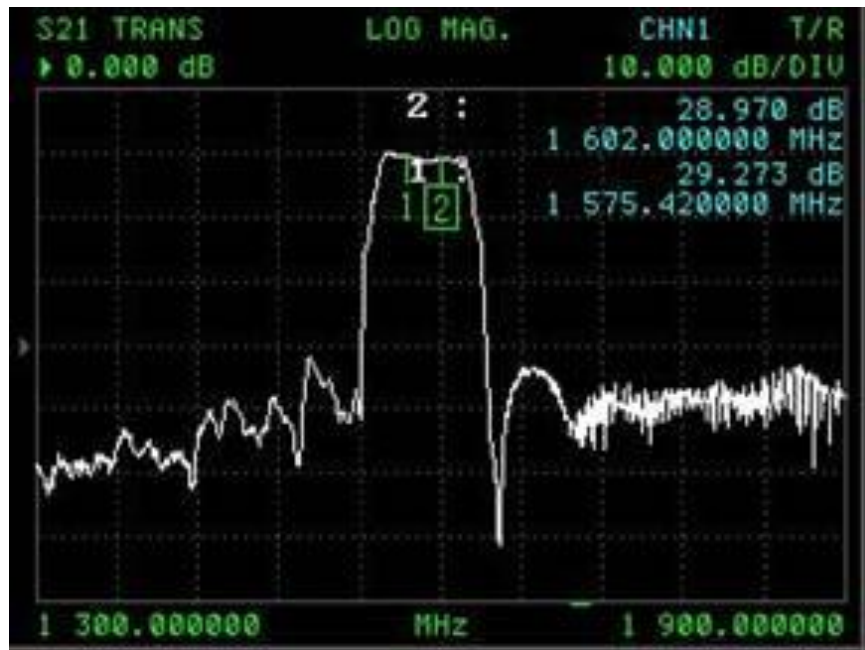

S22 Reverse Reflection

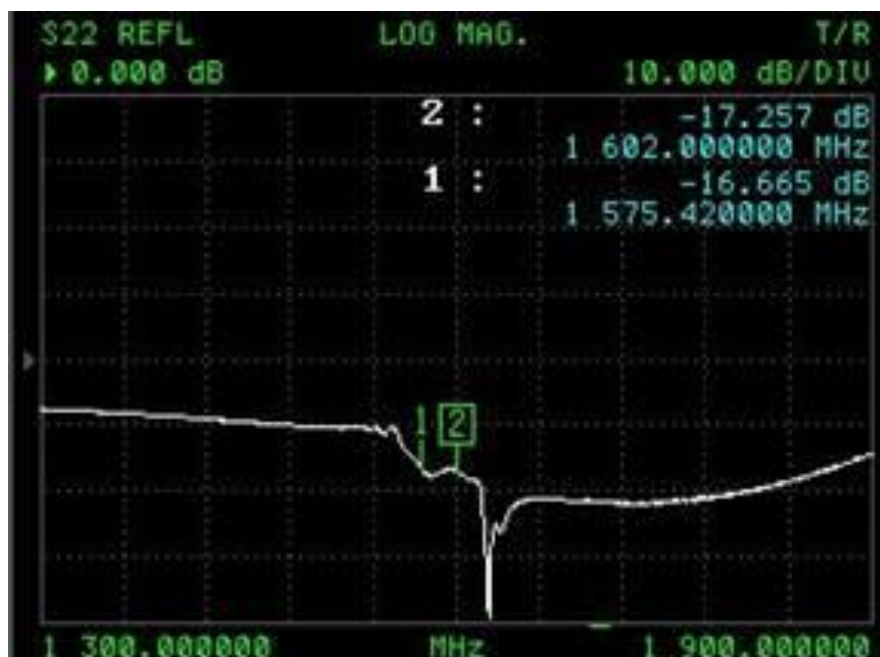

6. Drawing (Unit: mm)

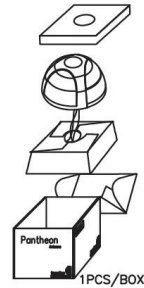
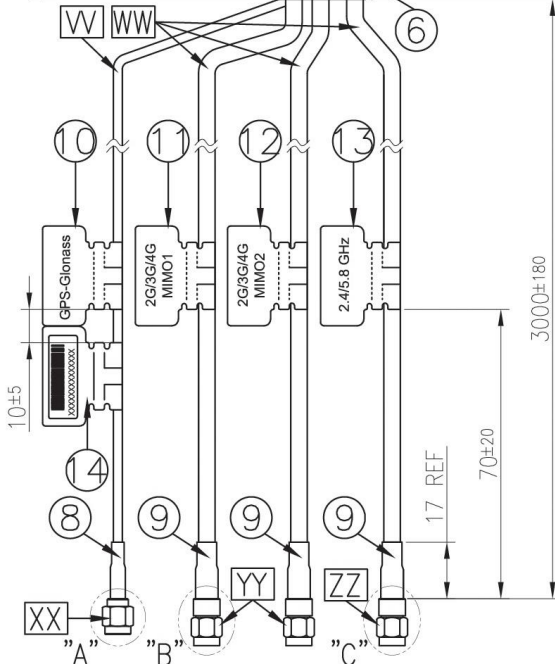
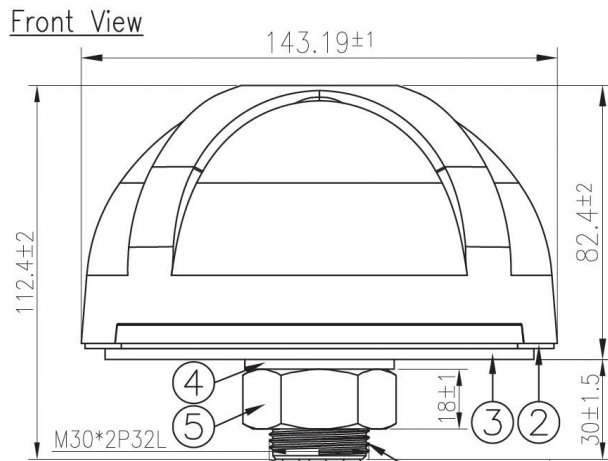
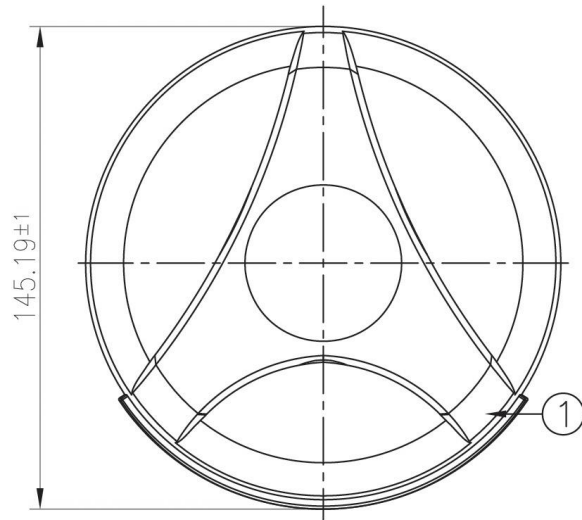

Bottom Thread View

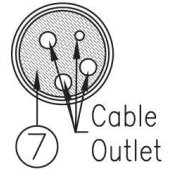

SMA(M)ST

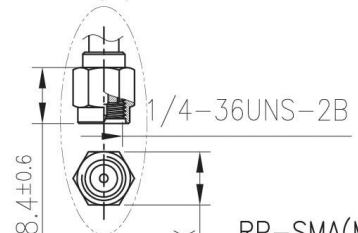

SMA(M)ST

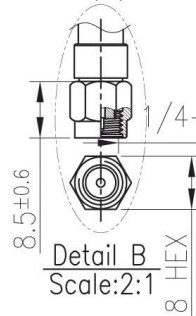

RP-SMA(M)ST

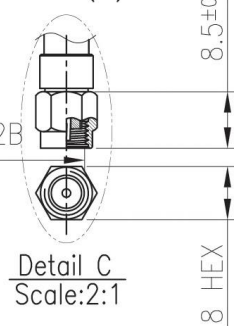

Note:

1. Part Number:MA760.A.A301111.B305111.I305111.C305151

Name	Material	Finish	QTY
1 Housing	PC540	Black	1
2 Waterproof Rubber	Silicone Rubber	Black	1
3 Double Sided Adhesive(Black Foam	3M 9448HK+CR4305	White Liner	1
4 Washer M30	Steel AISI 1006	Ni Plated	1
5 M30 Nut	Steel AISI 1006	Ni Plated	1
6 M30x2P Thread 32L	Zinc Alloy	Ni Plated	1
7 Rubber Stopper	Silicone Rubber	Black	1
8 Heat Shrink Tube	PE	Black	1
9 Heat Shrink Tube	PE	Black	3
10 GPS-Glonass Label	PEPA	Orange	1
11 2G/3G/4G MIMO1	PEPA	Gray	1
12 2G/3G/4G MIMO2	PEPA	White	1
13 2.4/5.8 GHz Label (48x30)	PEPA	Teal Green	1
14 Barcode Label (48*30)	PEPA	White	1

Name	Spec	Finish	QTY
XX Connector Type	SMA(M)ST	Au Plated	1
YY Connector Type	SMA(M)ST	Au Plated	2
ZZ Connector Type	RP-SMA(M)ST	Au Plated	1
W Cable Type	RG-174	Black	1
WW Cable Type	CFD-200	Black	3

7. Packaging

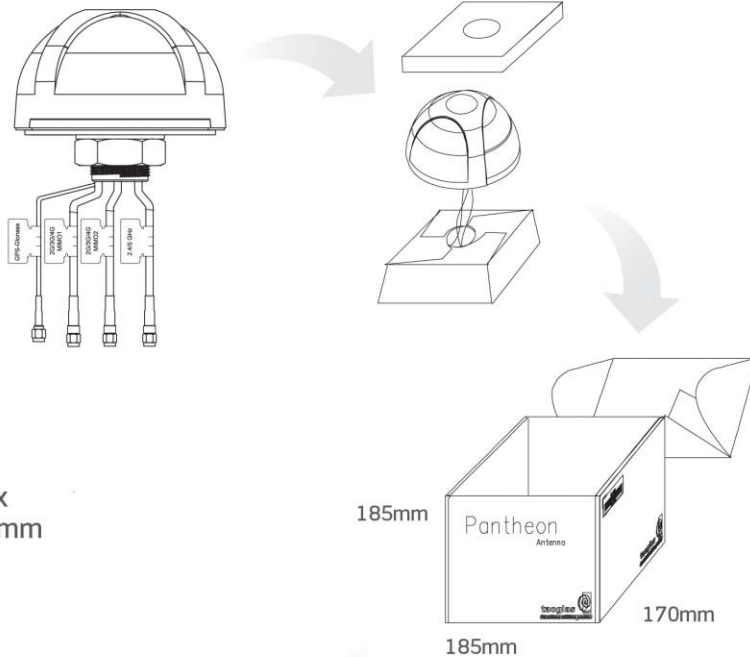

1 pcs MA760.B.ABIC.003 per box
 Box Dimensions - 185*170*185 mm
 Weight - 1460g

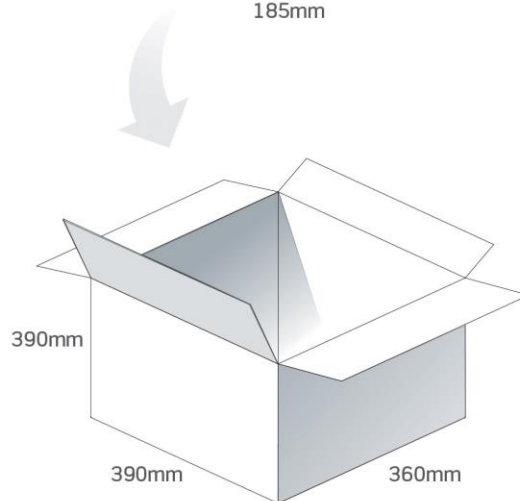

8 pcs MA760.B.ABIC.003 per carton
 Carton - 390 x 360 x 390mm
 Weight - 12.73Kg

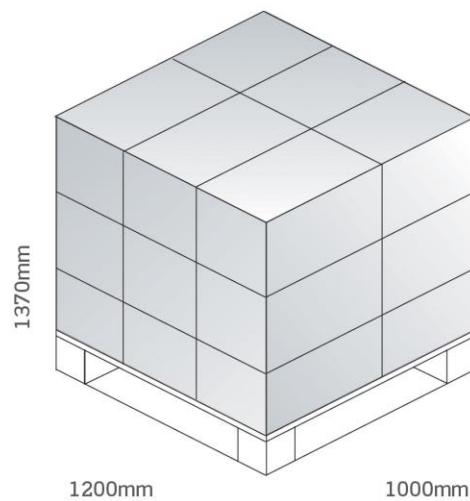

Pallet Dimensions 1200 x 1000 x 1370mm
 18 Cartons per Pallet
 6 Cartons per layer
 3 Layers

Taoglas makes no warranties based on the accuracy or completeness of the contents of this document and reserves the right to make changes to specifications and product descriptions at any time without notice.

Taoglas reserves the rights to this document and the information contained herein. Reproduction, use or disclosure to third parties without express permission is strictly prohibited.

Copyright © Taoglas Ltd.