

## L0603CR82KSMST

Aliases (L0603CR82KSMST)

Obsolete

KEMET, L-SMS, Commercial Grade, 0.82 uH, 10%

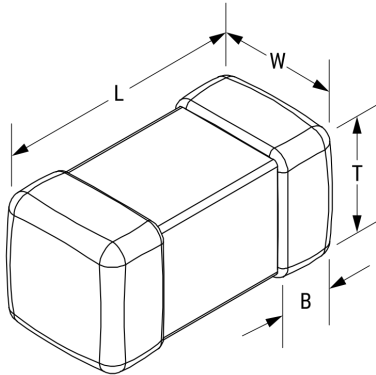

Click [here](#) for the 3D model.

### Dimensions

Chip Size	0603
L	1.6mm +/-0.15mm
W	0.8mm +/-0.15mm
T	0.8mm +/-0.15mm
LL	0.3mm +/-0.2mm
B	0.3mm +/-0.2mm

### Packaging Specifications

Packaging	T&R
Packaging Quantity	4000

### General Information

Series	L-SMS
Style	SMD Chip
Description	Shielded, Surface Mount Inductor
Features	Standard Type
RoHS	Yes
Core	Ceramic
Winding Type	Multilayer
Notes	Suggested Replacement - <a href="https://www.chilisin.com/en-global/Inductor/Product/BSCL_160808/BSCL00160808R82K00">https://www.chilisin.com/en-global/Inductor/Product/BSCL_160808/BSCL00160808R82K00</a> .

### Specifications

Inductance	0.82 uH
Inductance Tolerance	10%
Temperature Range	-40/+85°C
Current	35 mAmps (MAX)
DC Resistance	2.1 Ohms
Quality Factor	15 at 25 MHz
Self-Resonant Frequency	75 MHz