

## Description

The DIODES AS348/AS2348 are single/dual channels RRIO amplifiers (rail-to-rail input and output), which provide not only maximum output-voltage swing capability but also an extended 300mV common-mode voltage beyond the supply rail. The devices are fully specified to operate from 1.6V to 5.5V single-supply, or  $\pm 0.8V$  and  $\pm 2.5V$  dual-supply applications.

The devices feature a good speed/power consumption ratio, offering 1MHz gain bandwidth while consuming 70 $\mu A$  per channel (typ). They are unity-gain stable for capacitive loads up to 100pF. The low noise density 27nV/ $\sqrt{Hz}$ , low input offset voltage 0.5mV and low input offset drift 2 $\mu V/^{\circ}C$  make them ideal for applications that require precision. With the input bias current is 1pA at room temperature, it is well suitable for low-voltage, low-noise, and low-power applications.

The AS348/AS2348 offer industry-standard packages. The AS348 is available in the SOT25 package, and the AS2348 is offered in the MSOP-8 and SO-8 packages. Temperature is specified for operation: from  $-40^{\circ}C$  to  $+125^{\circ}C$  among all supply voltages. The wide temperature ranges and high ESD tolerance facilitate their use in harsh applications.

## Features

- Single-Supply Voltage Range: 1.6V to 5.5V
- Dual-Supply Voltage Range:  $\pm 0.8V$  to  $\pm 2.5V$
- Ultra-Low Input Bias Current: 1pA (typ)
- Offset Voltage: 0.5mV (typ), 2.5mV (max)
- Low Input Offset Drift: 2 $\mu V/^{\circ}C$  (typ)
- Rail-to-Rail Input  
 $V_{CM}$ : 300mV Beyond Supply Rail @  $V_{CC} = 3V$  or 5V  
 Rail-to-Rail Output Swing:  
 10k $\Omega$  Load: 4mV from Rail  
 1k $\Omega$  Load: 25mV from Rail
- Supply Current: 70 $\mu A$ /Channel (typ)
- Unity-Gain Stable up to 100pF Capacitive Load  
 Gain Bandwidth: 1.0MHz
- Slew Rate: 0.45V/ $\mu s$  @  $V_{CC} = 5.0V$
- Operation Ambient Temperature Range:  $-40^{\circ}C$  to  $+125^{\circ}C$
- ESD Protection JESD 22, 4000V HBM (A114)
- **Totally Lead-Free & Fully RoHS Compliant (Notes 1 & 2)**
- **Halogen and Antimony Free. "Green" Device (Note 3)**
- **For automotive applications requiring specific change control (i.e. parts qualified to AEC-Q100/101/104/200, PPAP capable, and manufactured in IATF 16949 certified facilities), please [contact us](mailto:contact@diodes.com) or your local Diodes representative. <https://www.diodes.com/quality/product-definitions/>**

Notes: 1. No purposely added lead. Fully EU Directive 2002/95/EC (RoHS), 2011/65/EU (RoHS 2) & 2015/863/EU (RoHS 3) compliant.  
 2. See <https://www.diodes.com/quality/lead-free/> for more information about Diodes Incorporated's definitions of Halogen- and Antimony-free, "Green" and Lead-free.  
 3. Halogen- and Antimony-free "Green" products are defined as those which contain <900ppm bromine, <900ppm chlorine (<1500ppm total Br + Cl) and <1000ppm antimony compounds.

## Pin Assignments

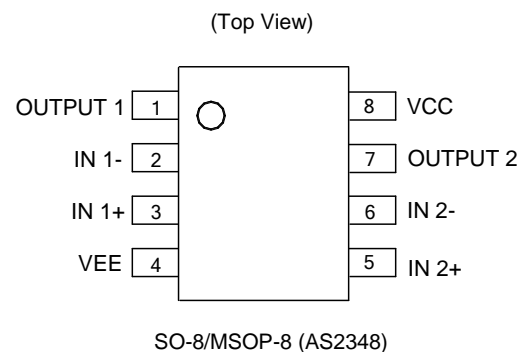
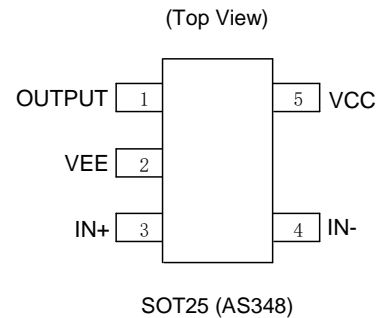

## Applications

- Active filters
- Sensors interfaces
- Photodiode amplification
- Smoke alarms, CO detectors
- Battery-powered applications
- Portable equipment
- Medical instrumentation
- Pulse blood oximeters, glucose meters

**Functional Block Diagram**

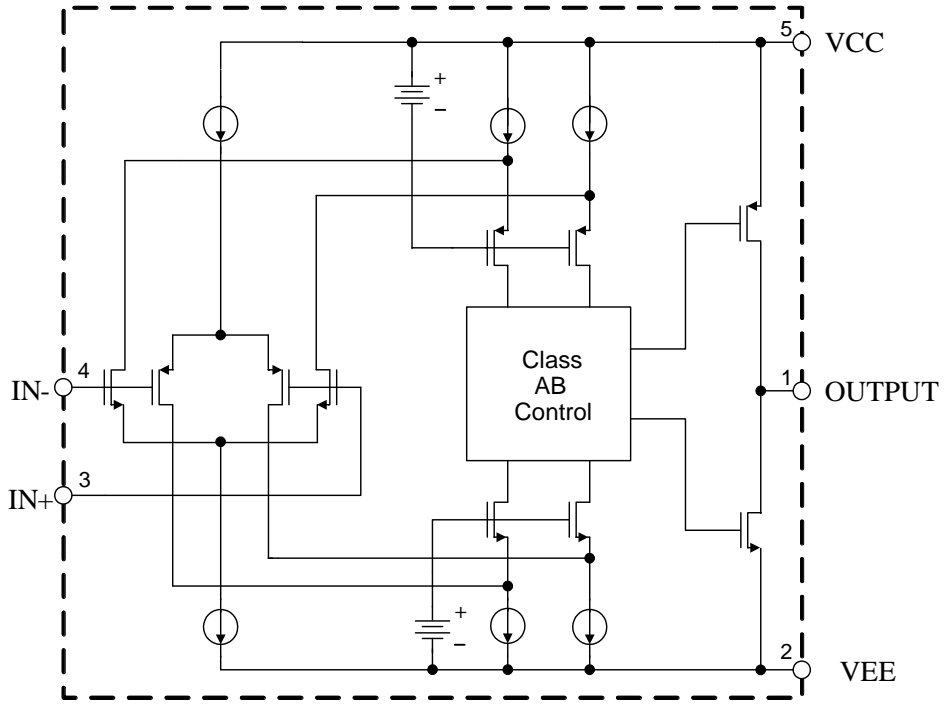

Block Diagram of AS348

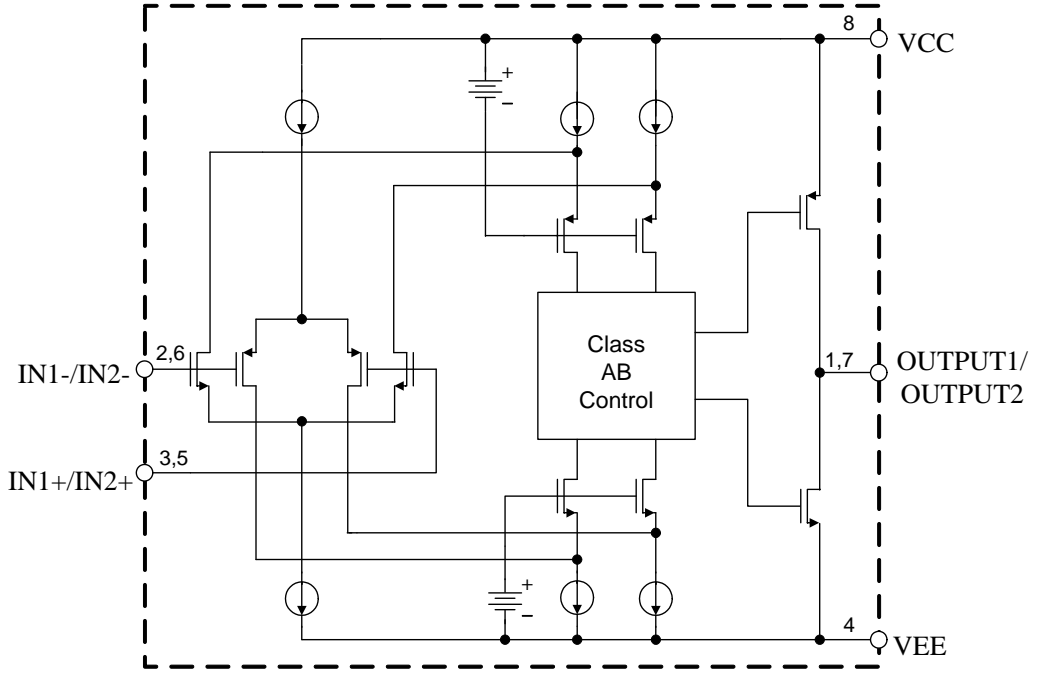

Block Diagram of AS2348

## Absolute Maximum Ratings (Note 4)

Symbol	Parameter	Rating	Unit	
V <sub>CC</sub>	Power-Supply Voltage	6.0	V	
V <sub>ID</sub>	Differential Input Voltage	6.0	V	
V <sub>IN</sub>	Input Voltage	-0.3 to V <sub>CC</sub> +0.5	V	
T <sub>J</sub>	Operating Junction Temperature	+150	°C	
θ <sub>JA</sub>	Thermal Resistance (Junction to Ambient)	SOT25	220	°C/W
		SO-8	150	
		MSOP-8	200	
T <sub>STG</sub>	Storage Temperature Range	-65 to +150	°C	
T <sub>LEAD</sub>	Lead Temperature (Soldering, 10 Seconds)	+260	°C	
—	ESD (Human Body Model)	±4000	V	
—	ESD (Machine Model)	±300	V	

Note 4: Stresses greater than those listed under “Absolute Maximum Ratings” can cause permanent damage to the device. These are stress ratings only, and functional operation of the device at these or any other conditions beyond those indicated under “Recommended Operating Conditions” is not implied. Exposure to “Absolute Maximum Ratings” for extended periods can affect device reliability.

## Recommended Operating Conditions

Symbol	Parameter	Min	Max	Unit
V <sub>CC</sub>	Supply Voltage	1.6	5.5	V
T <sub>A</sub>	Operating Ambient Temperature Range	-40	+125	°C

## Electrical Characteristics

**1.6V DC Electrical Characteristics** ( $V_{CC} = 1.6V$ ,  $V_{EE} = 0$ ,  $V_{OUT} = V_{CC}/2$ ,  $V_{CM} = V_{CC}/2$ ,  $T_A = +25^{\circ}C$ , unless otherwise specified.)

Symbol	Parameter	Conditions	Min	Typ	Max	Unit
$V_{OS}$	Input Offset Voltage	—	—	0.5	2.5	mV
$I_B$	Input Bias Current	—	—	1.0	—	pA
$I_{OS}$	Input Offset Current	—	—	1.0	—	pA
$V_{CM}$	Input Common-Mode Voltage Range	—	-0.2	—	1.8	V
CMRR	Common-Mode Rejection Ratio	$V_{CM} = -0.2V$ to $1.8V$	55	75	—	dB
$G_V$	Large Signal Voltage Gain	$R_L = 10k\Omega$ to $V_{CC}/2$ , $V_{OUT} = 0.2V$ to $1.4V$	90	110	—	dB
$\Delta V_{OS}/\Delta T$	Input Offset Voltage Drift	—	—	2.0	—	$\mu V/^{\circ}C$
$V_{OL}/V_{OH}$	Output-Voltage Swing from Rail	$R_L = 1k\Omega$ to $V_{CC}/2$	—	30	50	mV
		$R_L = 10k\Omega$ to $V_{CC}/2$	—	3	15	
$I_{SINK}$	Output Current	Sink	$V_{OUT} = V_{CC}$	8	10	mA
$I_{SOURCE}$		Source	$V_{OUT} = 0V$	5	8.5	
$Z_{OUT}$	Closed-Loop Output Impedance	$f = 10kHz$ , $A_V = 1$	—	9	—	$\Omega$
PSRR	Power-Supply Rejection Ratio	$V_{CC} = 1.6V$ to $5.0V$	66	80	—	dB
$I_{CC}$	Supply Current (Per Amplifier)	$V_{OUT} = V_{CC}/2$ , $I_{OUT} = 0$	—	70	90	$\mu A$

**1.6V AC Electrical Characteristics** ( $V_{CC} = 1.6V$ ,  $V_{EE} = 0$ ,  $V_{OUT} = V_{CC}/2$ ,  $V_{CM} = V_{CC}/2$ ,  $T_A = +25^{\circ}C$ , unless otherwise specified.)

Symbol	Parameter	Conditions	Min	Typ	Max	Unit
GBP	Gain Bandwidth Product	$C_L = 100pF$	—	1.0	—	MHz
SR	Slew Rate (Note 5)	1V Step, $C_L = 100pF$ , $R_L = 10k\Omega$	—	0.32	—	$V/\mu s$
$\phi_M$	Phase Margin	$R_L = 100k\Omega$	—	67	—	Degrees
THD+N	Total Harmonic Distortion+Noise	$f = 1kHz$ , $A_V = 1$ , $V_{IN} = 1V_{PP}$ , $R_L = 10k\Omega$ , $C_L = 100pF$	—	-70	—	dB
$e_n$	Voltage Noise Density	$f = 1kHz$	—	27	—	$nV/\sqrt{Hz}$

Note 5: Number specified is the positive slew rate.

**Electrical Characteristics** (continued)

**1.8V DC Electrical Characteristics** ( $V_{CC} = 1.8V$ ,  $V_{EE} = 0$ ,  $V_{OUT} = V_{CC}/2$ ,  $V_{CM} = V_{CC}/2$ ,  $T_A = +25^{\circ}C$ , unless otherwise specified.)

Symbol	Parameter		Conditions	Min	Typ	Max	Unit
$V_{OS}$	Input Offset Voltage		—	—	0.5	2.5	mV
$I_B$	Input Bias Current		—	—	1.0	—	pA
$I_{OS}$	Input Offset Current		—	—	1.0	—	pA
$V_{CM}$	Input Common-Mode Voltage Range		—	-0.2	—	2.0	V
CMRR	Common-Mode Rejection Ratio		$V_{CM} = -0.2V$ to $2.0V$	55	75	—	dB
$G_V$	Large Signal Voltage Gain		$R_L = 10k\Omega$ to $V_{CC}/2$ , $V_{OUT} = 0.2V$ to $1.6V$	90	112	—	dB
$\Delta V_{OS}/\Delta T$	Input Offset Voltage Drift		—	—	2.0	—	$\mu V/^{\circ}C$
$V_{OL}/V_{OH}$	Output-Voltage Swing from Rail		$R_L = 1k\Omega$ to $V_{CC}/2$	—	25	50	mV
			$R_L = 10k\Omega$ to $V_{CC}/2$	—	3	15	
$I_{SINK}$	Output Current	Sink	$V_{OUT} = V_{CC}$	12	16	—	mA
$I_{SOURCE}$		Source	$V_{OUT} = 0V$	10	14	—	
$Z_{OUT}$	Closed-Loop Output Impedance		$f = 10kHz$	—	9	—	$\Omega$
PSRR	Power-Supply Rejection Ratio		$V_{CC} = 1.6V$ to $5.0V$	66	80	—	dB
$I_{CC}$	Supply Current (Per Amplifier)		$V_{OUT} = V_{CC}/2$ , $I_{OUT} = 0$	—	70	90	$\mu A$

**1.8V AC Electrical Characteristics** ( $V_{CC} = 1.8V$ ,  $V_{EE} = 0$ ,  $V_{OUT} = V_{CC}/2$ ,  $V_{CM} = V_{CC}/2$ ,  $T_A = +25^{\circ}C$ , unless otherwise specified.)

Symbol	Parameter		Conditions	Min	Typ	Max	Unit
GBP	Gain Bandwidth Product		$C_L = 100pF$	—	1.0	—	MHz
SR	Slew Rate (Note 5)		1V Step, $C_L = 100pF$ , $R_L = 10k\Omega$	—	0.34	—	V/ $\mu s$
$\phi_M$	Phase Margin		$R_L = 100k\Omega$	—	67	—	Degrees
THD+N	Total Harmonic Distortion+Noise		$f = 1kHz$ , $A_V = 1$ , $V_{IN} = 1V_{PP}$ , $R_L = 10k\Omega$ , $C_L = 100pF$	—	-70	—	dB
$e_n$	Voltage Noise Density		$f = 1kHz$	—	27	—	$nV/\sqrt{Hz}$

Note 5: Number specified is the positive slew rate.

**Electrical Characteristics** (continued)

**3.0V DC Electrical Characteristics** ( $V_{CC} = 3.0V$ ,  $V_{EE} = 0$ ,  $V_{OUT} = V_{CC}/2$ ,  $V_{CM} = V_{CC}/2$ ,  $T_A = +25^\circ C$ , unless otherwise specified.)

Symbol	Parameter		Conditions	Min	Typ	Max	Unit
$V_{OS}$	Input Offset Voltage		—	—	0.5	2.5	mV
$I_B$	Input Bias Current		—	—	1.0	—	pA
$I_{OS}$	Input Offset Current		—	—	1.0	—	pA
$V_{CM}$	Input Common-Mode Voltage Range		—	-0.3	—	3.3	V
CMRR	Common-Mode Rejection Ratio		$V_{CM} = -0.3V$ to $1.8V$	62	80	—	dB
			$V_{CM} = -0.3V$ to $3.3V$	58	75	—	
$G_V$	Large Signal Voltage Gain		$R_L = 1k\Omega$ to $V_{CC}/2$ , $V_{OUT} = 0.2V$ to $2.8V$	90	110	—	dB
			$R_L = 10k\Omega$ to $V_{CC}/2$ , $V_{OUT} = 0.1V$ to $2.9V$	95	115	—	
$\Delta V_{OS}/\Delta T$	Input Offset Voltage Drift		—	—	2.0	—	$\mu V/^\circ C$
$V_{OL}/V_{OH}$	Output-Voltage Swing from Rail		$R_L = 1k\Omega$ to $V_{CC}/2$	—	20	50	mV
			$R_L = 10k\Omega$ to $V_{CC}/2$	—	3	15	
$I_{SINK}$	Output Current	Sink	$V_{OUT} = V_{CC}$	50	60	—	mA
$I_{SOURCE}$		Source	$V_{OUT} = 0V$	50	65	—	
$Z_{OUT}$	Closed-Loop Output Impedance		$f = 10kHz$	—	9	—	$\Omega$
PSRR	Power-Supply Rejection Ratio		$V_{CC} = 1.6V$ to $5.0V$	66	80	—	dB
$I_{CC}$	Supply Current (Per Amplifier)		$V_{OUT} = V_{CC}/2$ , $I_{OUT} = 0$	—	70	90	$\mu A$

**3.0V AC Electrical Characteristics** ( $V_{CC} = 3.0V$ ,  $V_{EE} = 0$ ,  $V_{OUT} = V_{CC}/2$ ,  $V_{CM} = V_{CC}/2$ ,  $T_A = +25^\circ C$ , unless otherwise specified.)

Symbol	Parameter		Conditions	Min	Typ	Max	Unit
GBP	Gain Bandwidth Product		$C_L = 100pF$	—	1.0	—	MHz
SR	Slew Rate (Note 5)		$G = 1$ , $2V$ Step, $C_L = 100pF$ , $R_L = 10k\Omega$	—	0.40	—	$V/\mu s$
$\phi_M$	Phase Margin		$R_L = 100k\Omega$	—	67	—	Degrees
THD+N	Total Harmonic Distortion+Noise		$f = 1kHz$ , $G = 1$ , $V_{IN} = 1V_{PP}$ , $R_L = 10k\Omega$ , $C_L = 100pF$	—	-70	—	dB
$e_n$	Voltage Noise Density		$f = 1kHz$	—	27	—	$nV/\sqrt{Hz}$

Note 5: Number specified is the positive slew rate.

**Electrical Characteristics** (continued)

**5.0V DC Electrical Characteristics** ( $V_{CC} = 5.0V$ ,  $V_{EE} = 0$ ,  $V_{OUT} = V_{CC}/2$ ,  $V_{CM} = V_{CC}/2$ ,  $T_A = +25^\circ C$ , unless otherwise specified.)

Symbol	Parameter		Conditions	Min	Typ	Max	Unit
$V_{OS}$	Input Offset Voltage		—	—	0.5	2.5	mV
$I_B$	Input Bias Current		—	—	1.0	—	pA
$I_{OS}$	Input Offset Current		—	—	1.0	—	pA
$V_{CM}$	Input Common-Mode Voltage Range		—	-0.3	—	5.3	V
CMRR	Common-Mode Rejection Ratio		$V_{CM} = -0.3V$ to $3.8V$	70	85	—	dB
			$V_{CM} = -0.3V$ to $5.3V$	65	90	—	
$G_V$	Large Signal Voltage Gain		$R_L = 1k\Omega$ to $V_{CC}/2$ , $V_{OUT} = 0.2V$ to $4.8V$	80	92	—	dB
			$R_L = 10k\Omega$ to $V_{CC}/2$ , $V_{OUT} = 0.05V$ to $4.95V$	85	98	—	
$\Delta V_{OS}/\Delta T$	Input Offset Voltage Drift		—	—	2.0	—	$\mu V/^\circ C$
$V_{OL}/V_{OH}$	Output-Voltage Swing from Rail		$R_L = 1k\Omega$ to $V_{CC}/2$	—	25	50	mV
			$R_L = 10k\Omega$ to $V_{CC}/2$	—	4	15	
$I_{SINK}$	Output Current	Sink	$V_{OUT} = V_{CC}$	100	150	—	mA
$I_{SOURCE}$		Source	$V_{OUT} = 0V$	110	185	—	
—	Closed-Loop Output Impedance		$f = 1kHz$ , $A_V = 1$	—	9	—	$\Omega$
PSRR	Power-Supply Rejection Ratio		$V_{CC} = 1.6V$ to $5.0V$	66	80	—	dB
$I_{CC}$	Supply Current (Per Amplifier)		$V_{OUT} = V_{CC}/2$ , $I_{OUT} = 0$	—	70	90	$\mu A$

**5.0V AC Electrical Characteristics** ( $V_{CC} = 5.0V$ ,  $V_{EE} = 0$ ,  $V_{OUT} = V_{CC}/2$ ,  $V_{CM} = V_{CC}/2$ ,  $T_A = +25^\circ C$ , unless otherwise specified.)

Symbol	Parameter	Conditions	Min	Typ	Max	Unit
GBP	Gain Bandwidth Product	$C_L = 100pF$	—	1.0	—	MHz
SR	Slew Rate (Note 5)	2V Step, $C_L = 100pF$ , $R_L = 10k\Omega$	—	0.45	—	$V/\mu s$
$\phi_M$	Phase Margin	$R_L = 100k\Omega$	—	67	—	Degrees
THD+N	THD+N	$f = 1kHz$ , $A_V = 1$ , $V_{IN} = 1V_{PP}$ , $R_L = 10k\Omega$ , $C_L = 100pF$	—	-70	—	dB
$e_n$	Voltage Noise Density	$f = 1kHz$	—	27	—	$nV/\sqrt{Hz}$

Note 5: Number specified is the positive slew rate.

**Performance Characteristics**

**Supply Current vs. Temperature**

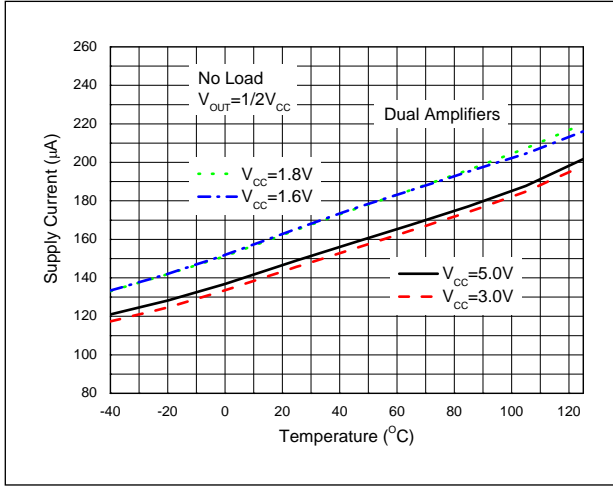

**Supply Current vs. Supply Voltage**

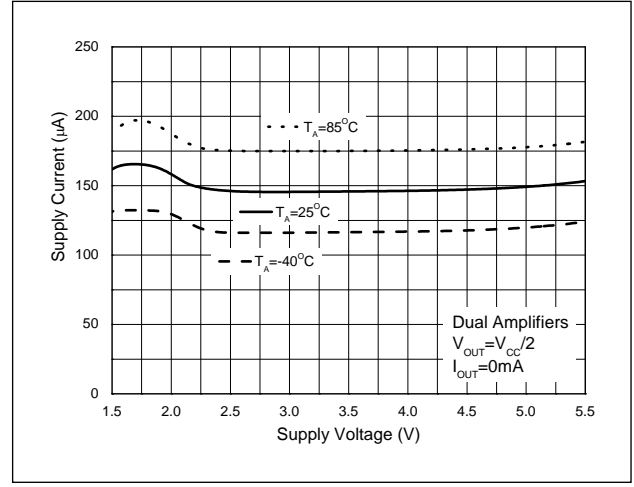

**Input Offset Voltage vs. Input Common Mode Voltage**

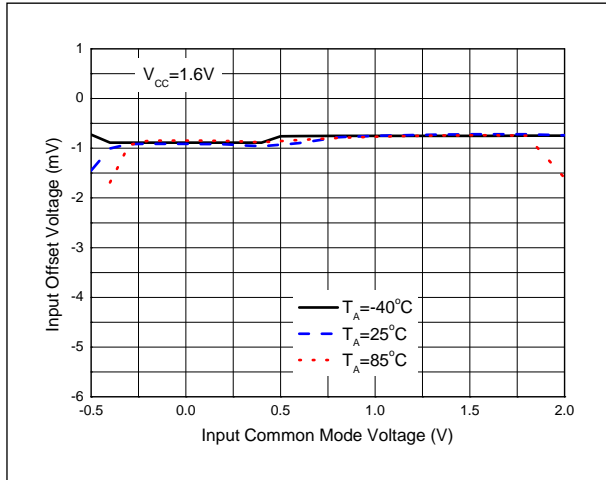

**Input Offset Voltage vs. Input Common Mode Voltage**

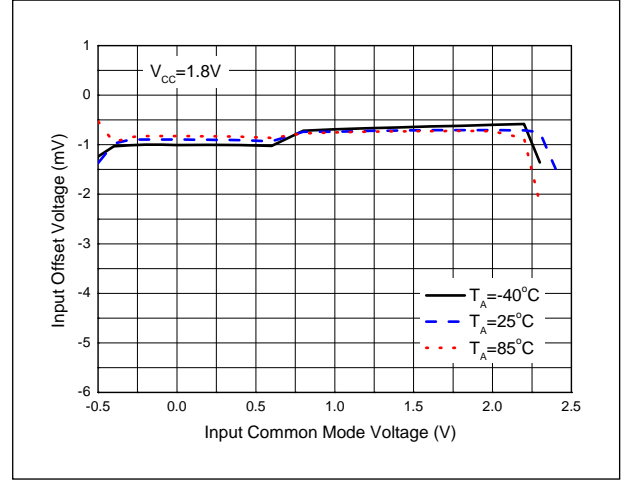

**Input Offset Voltage vs. Input Common Mode Voltage**

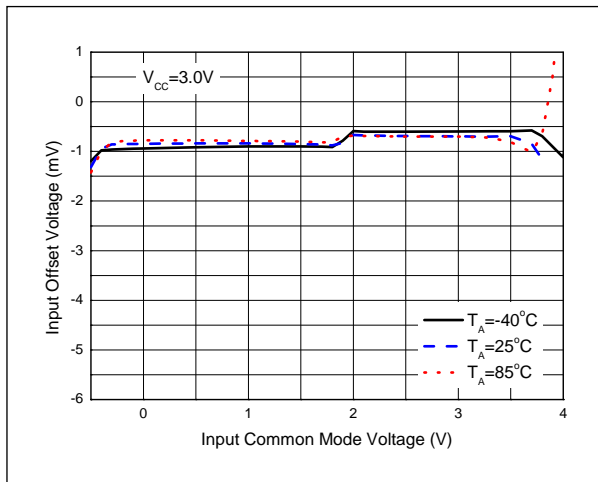

**Input Offset Voltage vs. Input Common Mode Voltage**

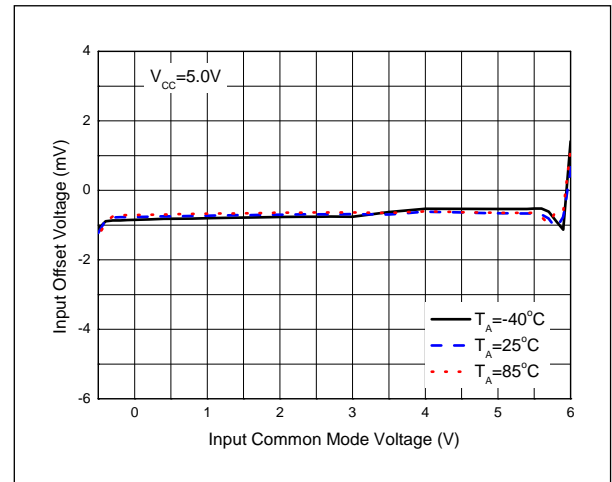



**Performance Characteristics** (continued)

**Output Voltage vs. Output Current**

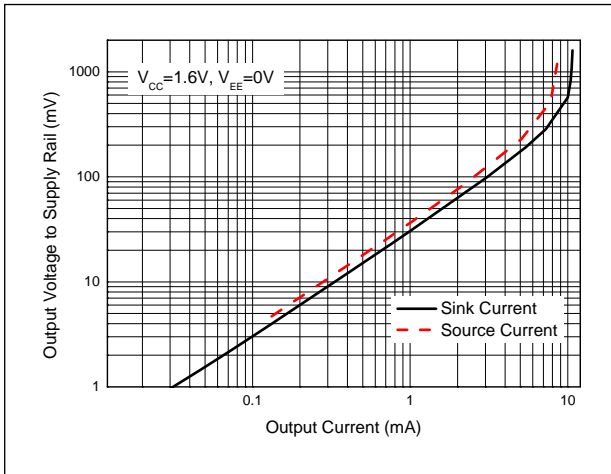

**Output Voltage vs. Output Current**

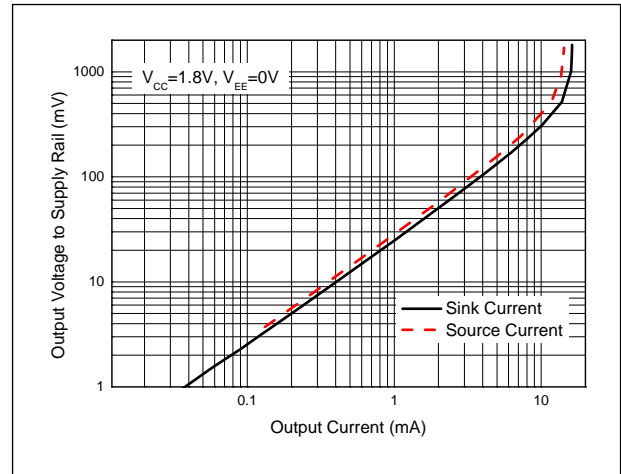

**Output Voltage vs. Output Current**

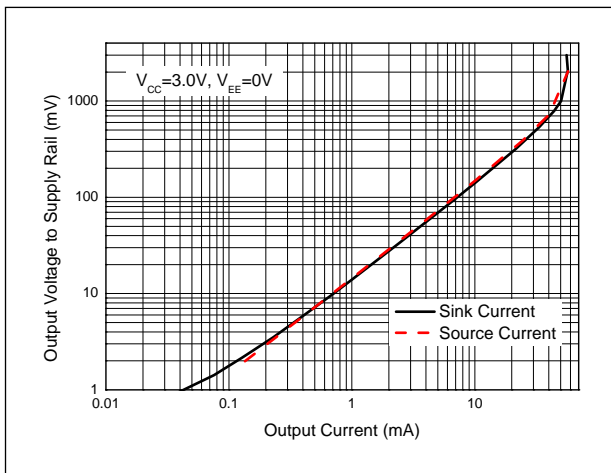

**Output Voltage vs. Output Current**

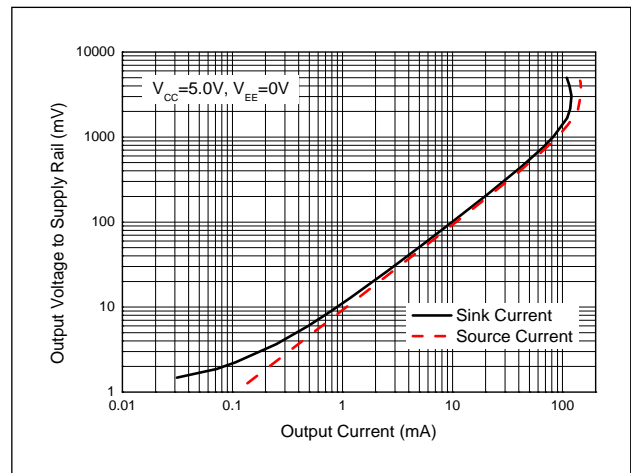

**Output Short Circuit Current vs. Temperature**

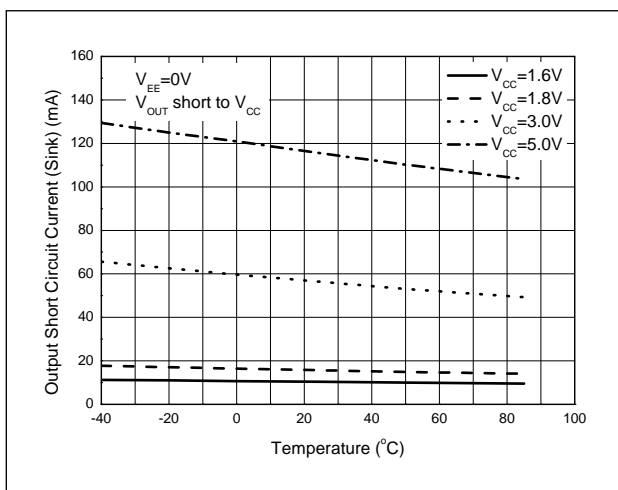

**Output Short Circuit Current vs. Temperature**

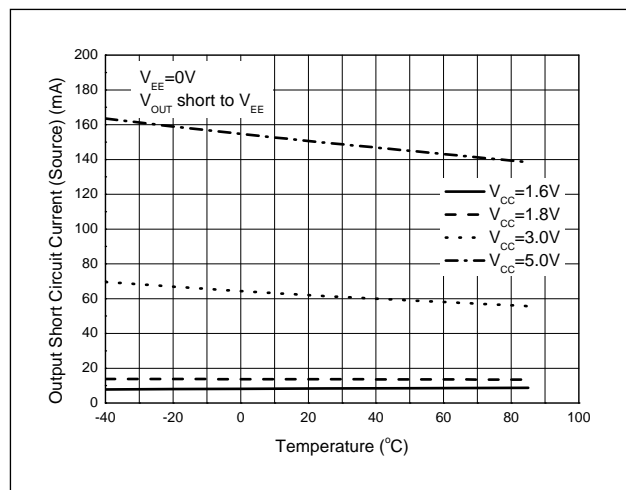

**Performance Characteristics** (continued)

**Output Short Circuit Current vs. Supply Voltage**

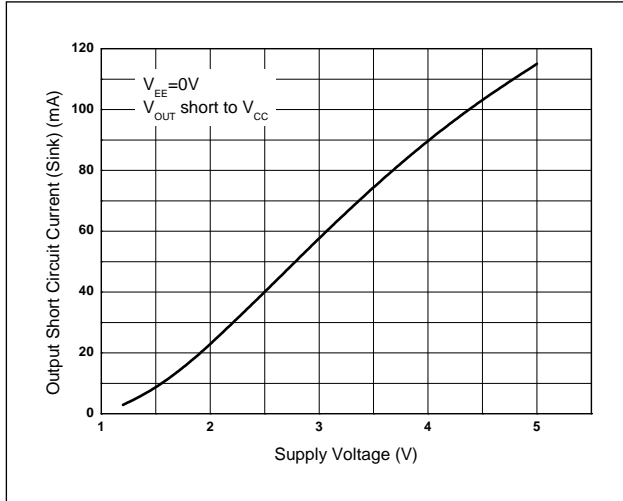

**Output Short Circuit Current vs. Supply Voltage**

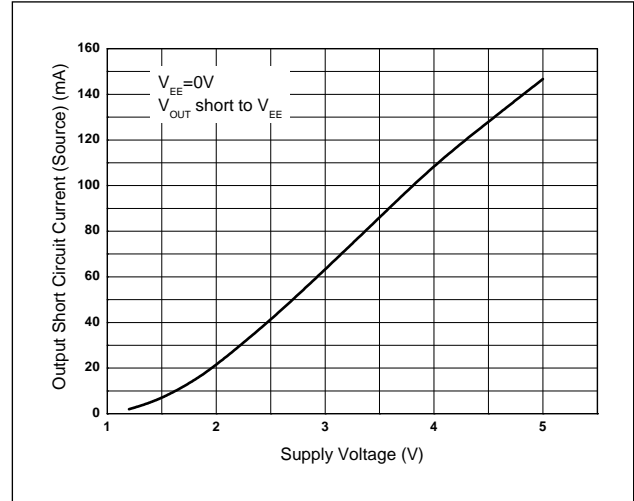

**Output Voltage Swing vs. Supply Voltage**

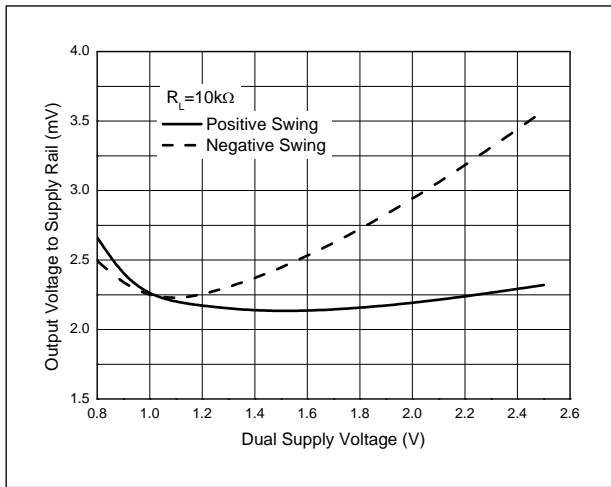

**Output Voltage Swing vs. Supply Voltage**

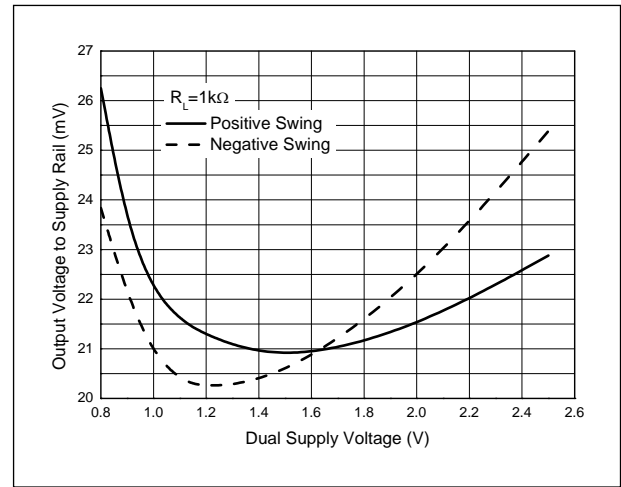

**Output Voltage Swing vs. Temperature**

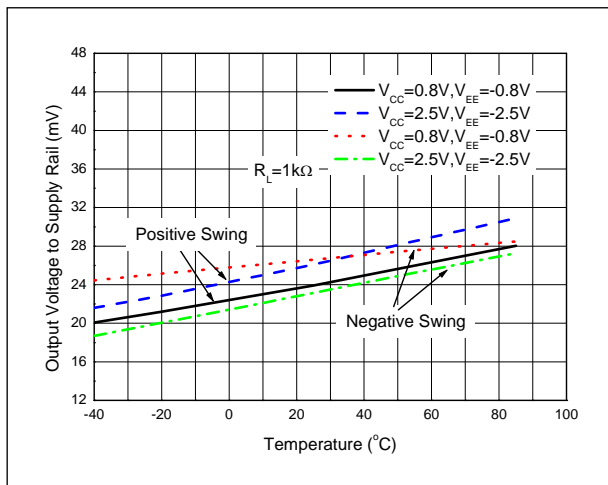

**Output Voltage Swing vs. Temperature**

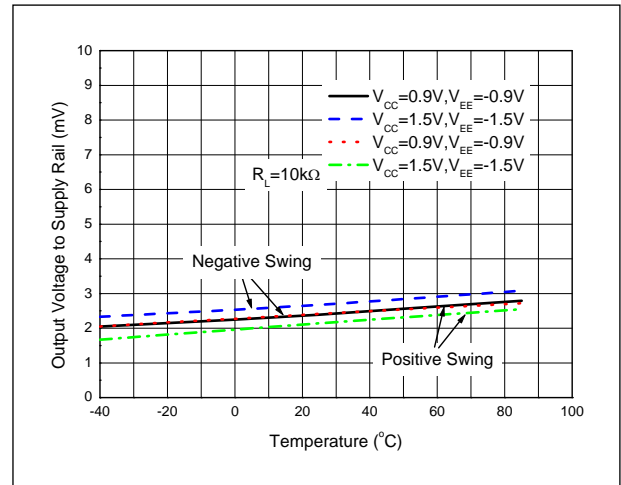

**Performance Characteristics** (continued)

**Gain and Phase vs. Frequency  
with Resistive Load**

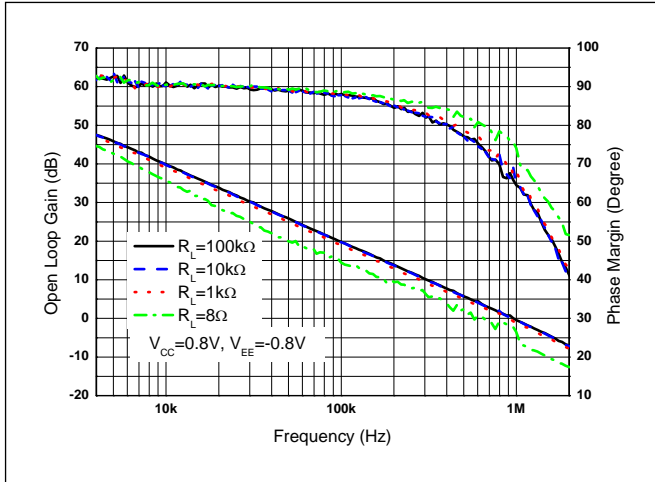

**Gain and Phase vs. Frequency  
with Capacitive Load**

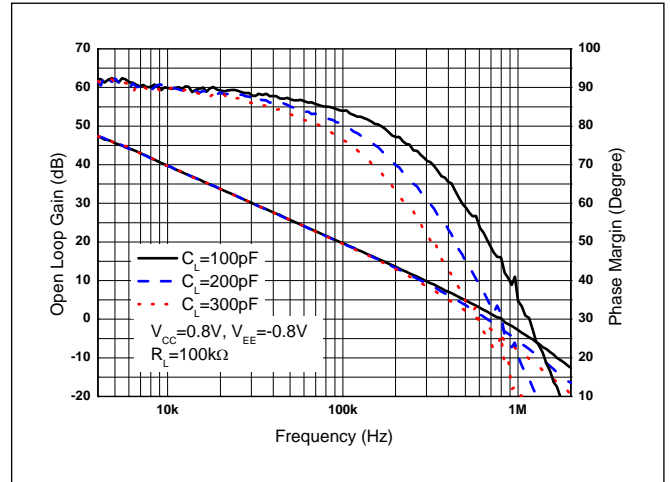

**Gain and Phase vs. Frequency  
with Capacitive Load**

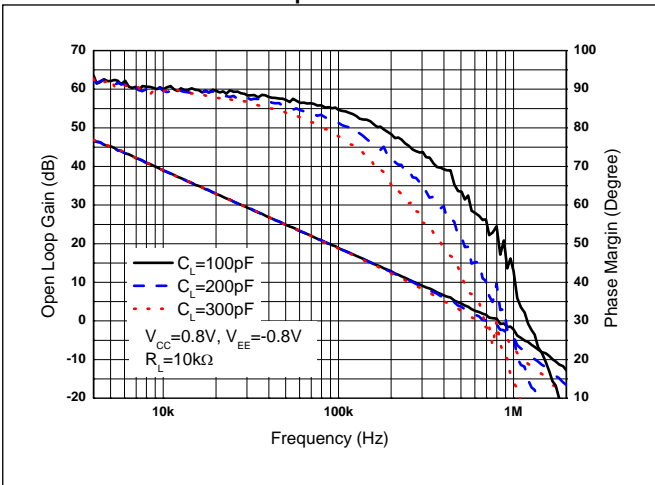

**Gain and Phase vs. Frequency  
with Resistive Load**

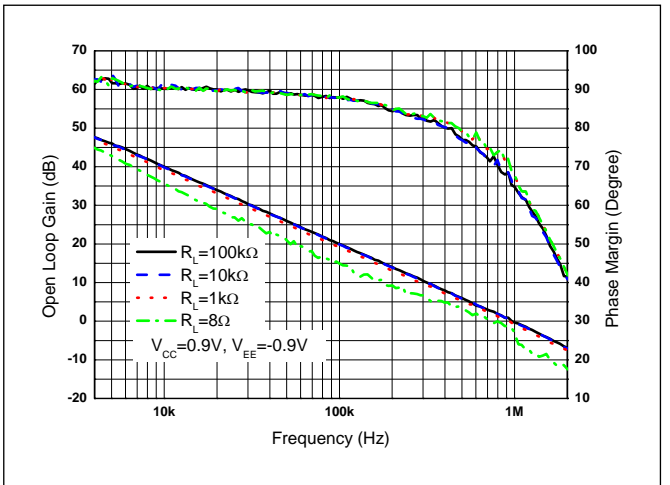

**Gain and Phase vs. Frequency  
with Capacitive Load**

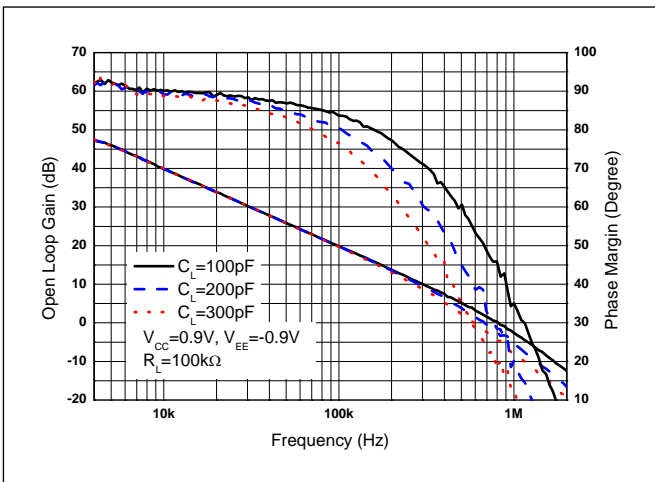

**Gain and Phase vs. Frequency  
with Capacitive Load**

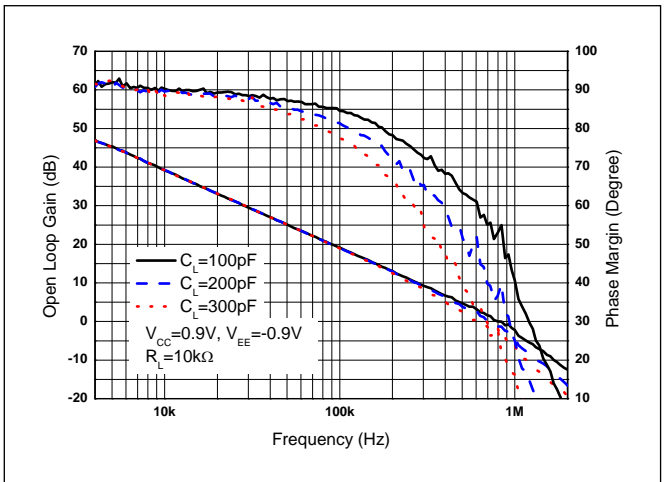

**Performance Characteristics** (continued)

**Gain and Phase vs. Frequency  
with Resistive Load**

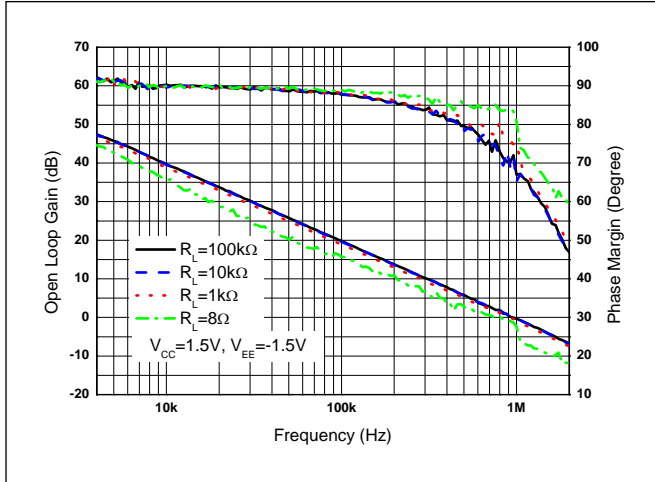

**Gain and Phase vs. Frequency  
with Capacitive Load**

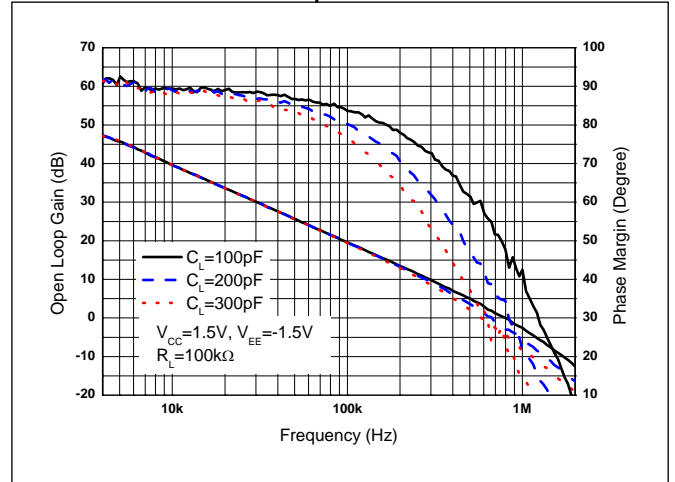

**Gain and Phase vs. Frequency  
with Capacitive Load**

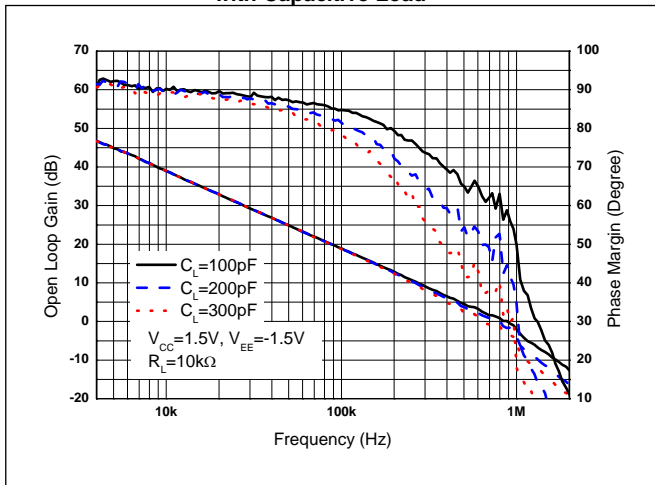

**Gain and Phase vs. Frequency  
with Resistive Load**

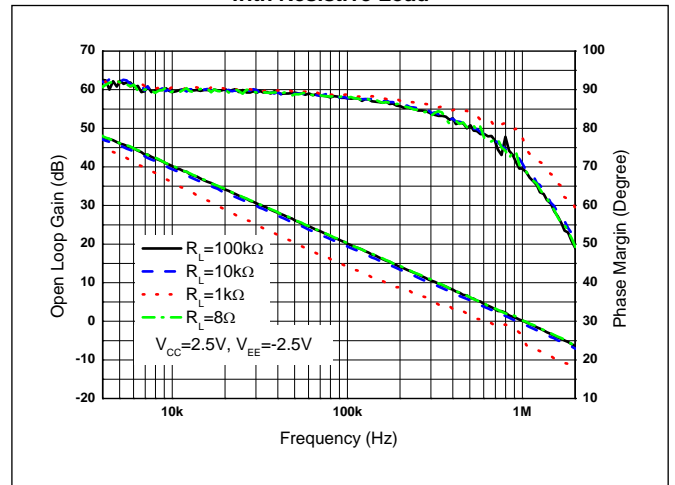

**Gain and Phase vs. Frequency  
with Capacitive Load**

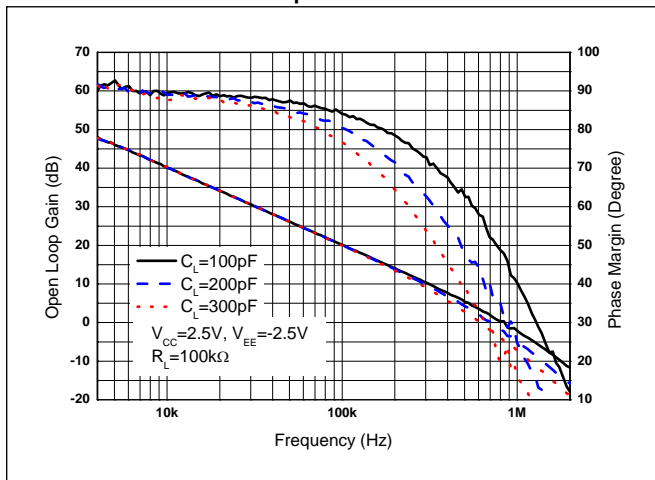

**Gain and Phase vs. Frequency  
with Capacitive Load**

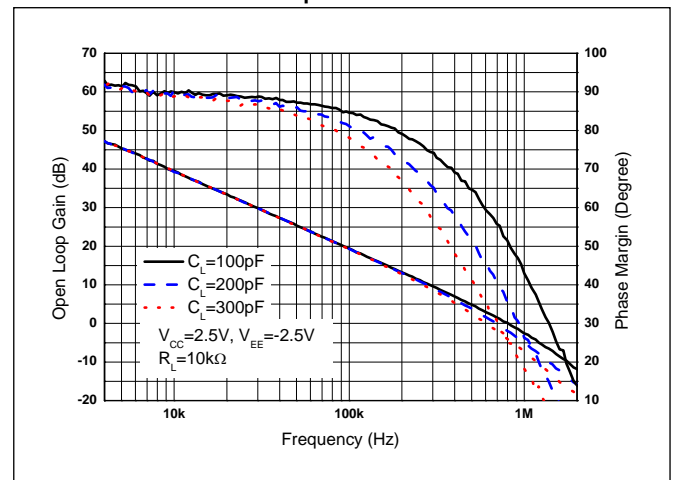

**Performance Characteristics** (continued)

**Output Impedance vs. Frequency**

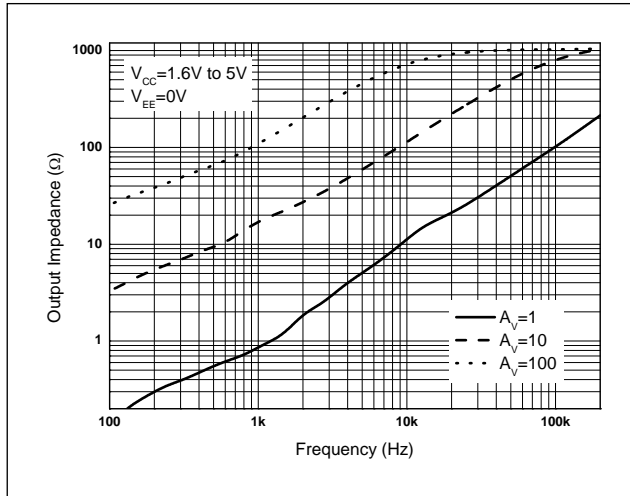

**THD+N vs. Output Voltage**

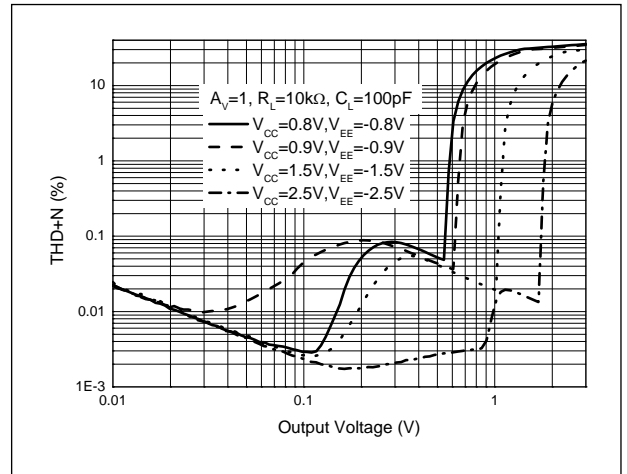

**THD+N vs. Frequency**

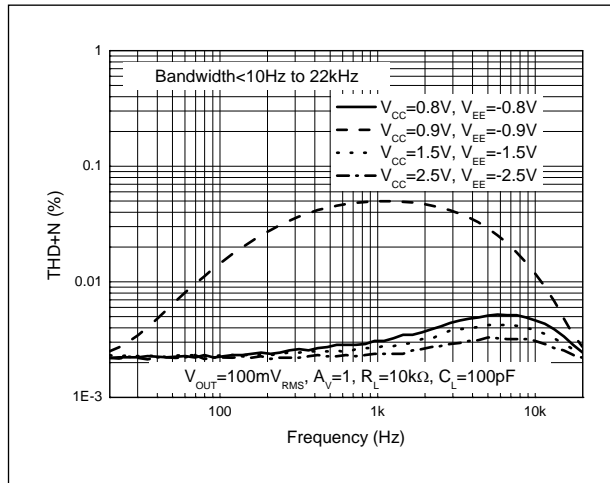

**Input Voltage Noise Density**

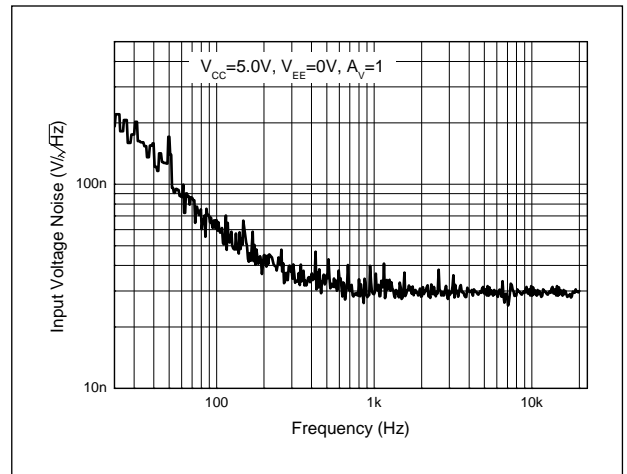

**Small Signal Pulse Response**

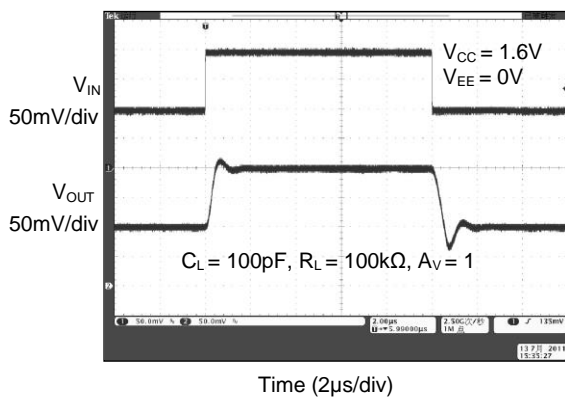

**Small Signal Pulse Response**

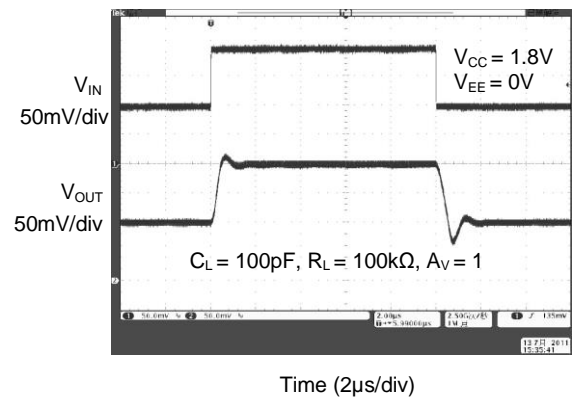

**Performance Characteristics** (continued)

**Small Signal Pulse Response**

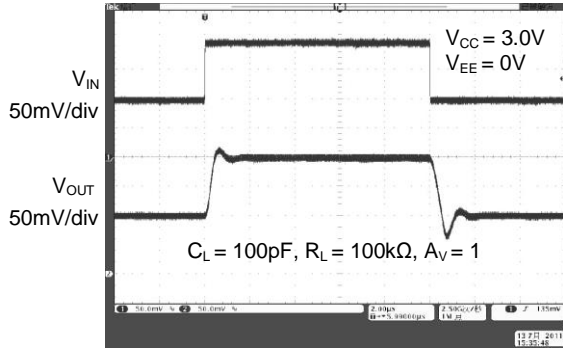

**Small Signal Pulse Response**

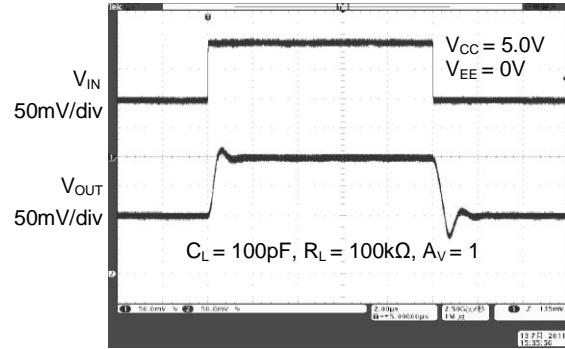

**Large Signal Pulse Response**

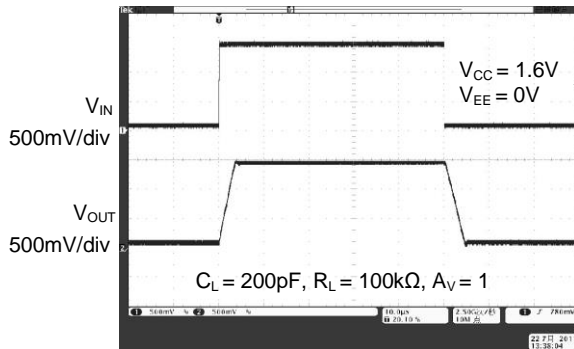

**Large Signal Pulse Response**

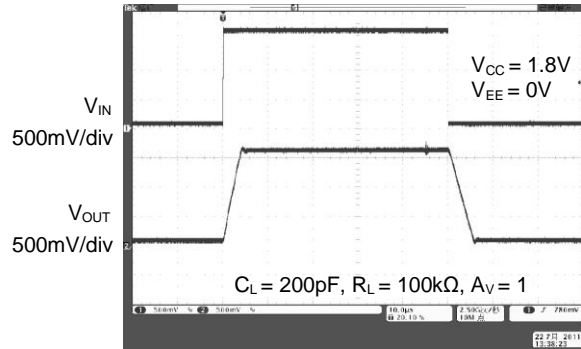

**Large Signal Pulse Response**

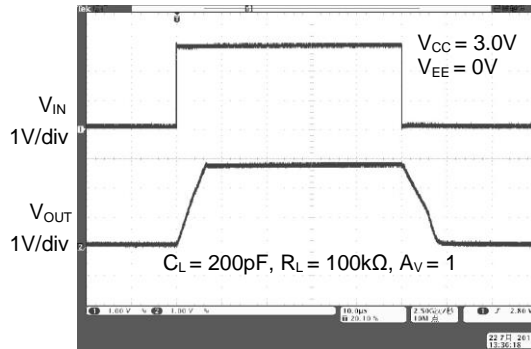

**Large Signal Pulse Response**

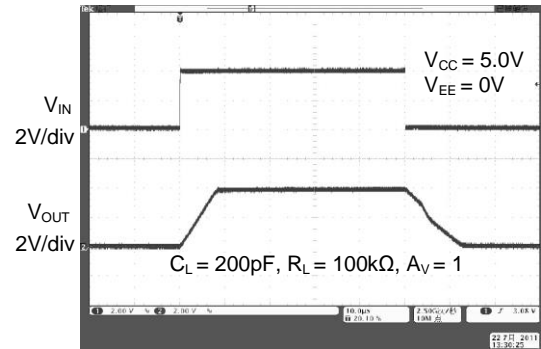

**Performance Characteristics** (continued)

**Large Signal Pulse Response**

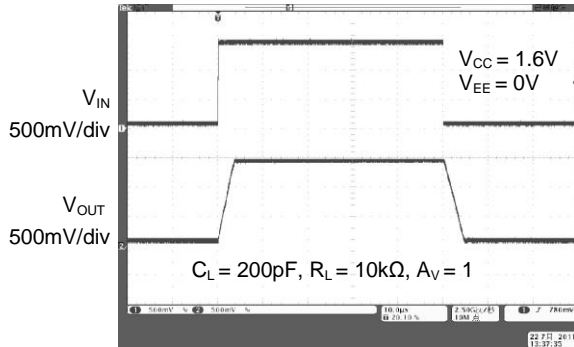

**Large Signal Pulse Response**

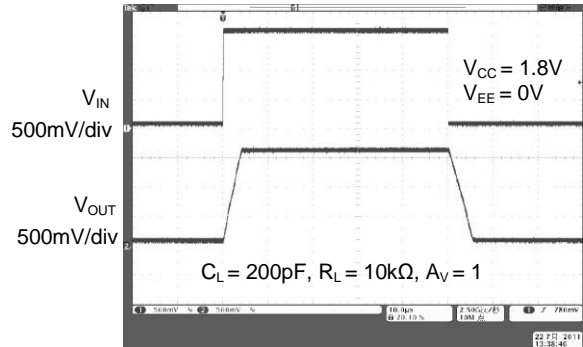

**Large Signal Pulse Response**

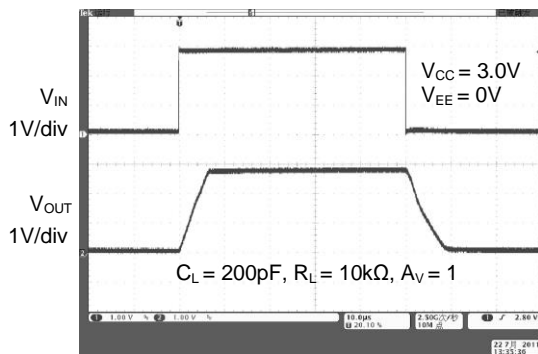

**Large Signal Pulse Response**

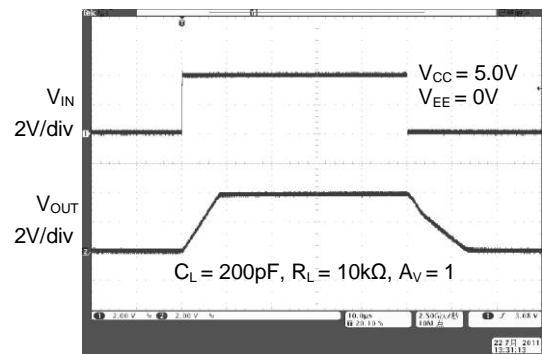

**No Phase Reversal**

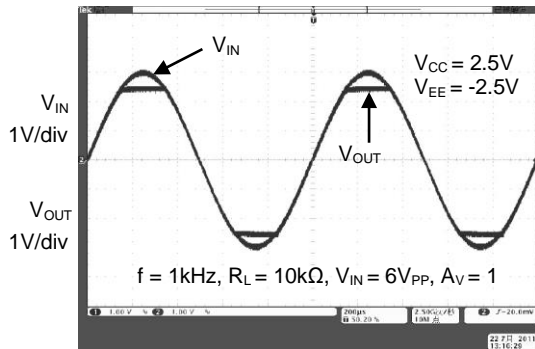

**Overload Recovery Time**

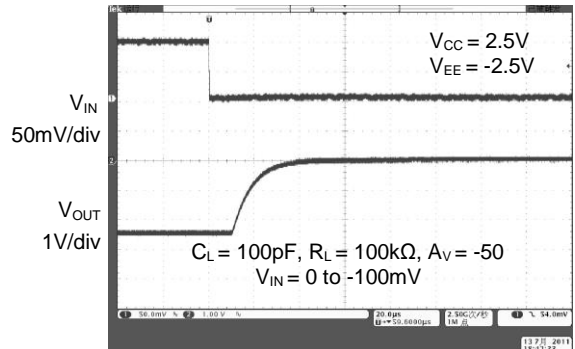

**Performance Characteristics** (continued)

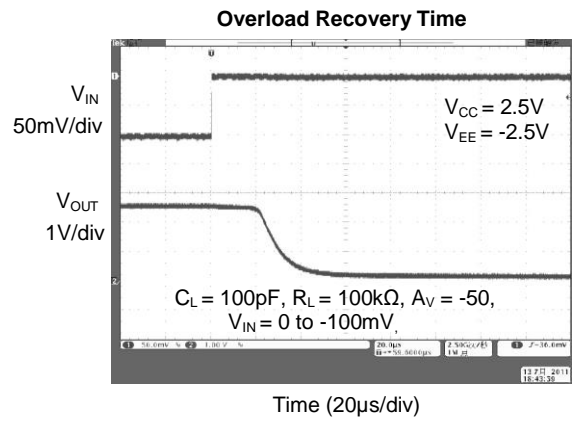



## Ordering Information

AS348/AS2348 X - X

Package

W5: SOT25  
S: SO-8  
M8:MSOP-8

Packing

7: 7" Tape & Reel  
13: 13" Tape & Reel

Part Number	Package Code	Package	Packing	
			Qty.	Carrier
AS348W5-7	W5	SOT25	3,000	7" Tape and Reel
AS2348S-13	S	SO-8	4,000	13" Tape and Reel
AS2348M8-13	M8	MSOP-8	3,000	13" Tape and Reel

## Marking Information

(1) SOT25

(Top View)

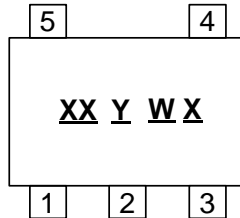

XX : Identification Code  
Y : Year 0 to 9  
W : Week : A to Z : 1 to 26 week;  
a to z : 27 to 52 week; z represents  
52 and 53 week  
X : Internal Code

Part Number	Package	Identification Code
AS348W5-7	SOT25	PH

(2) SO-8

(Top View)

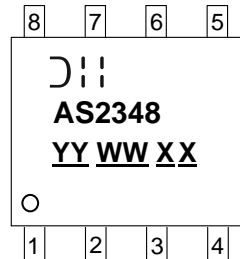

YY : Year : 23, 24, 25~  
WW : Week : 01~52; 52  
represents 52 and 53 week  
XX : Internal Code

Part Number	Package	Identification Code
AS2348S-13	SO-8	AS2348

(3) MSOP-8

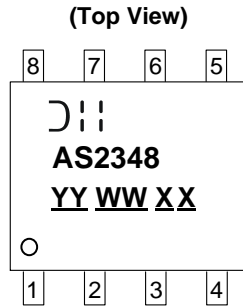

YY : Year : 23, 24, 25~  
WW : Week : 01~52; 52 represents 52 and 53 week  
XX : Internal Code

Part Number	Package	Identification Code
AS2348M8-13	MSOP-8	AS2348

**Package Outline Dimensions** (All dimensions in mm(inch).)

Please see <http://www.diodes.com/package-outlines.html> for the latest version.

(1) Package Type: SOT25

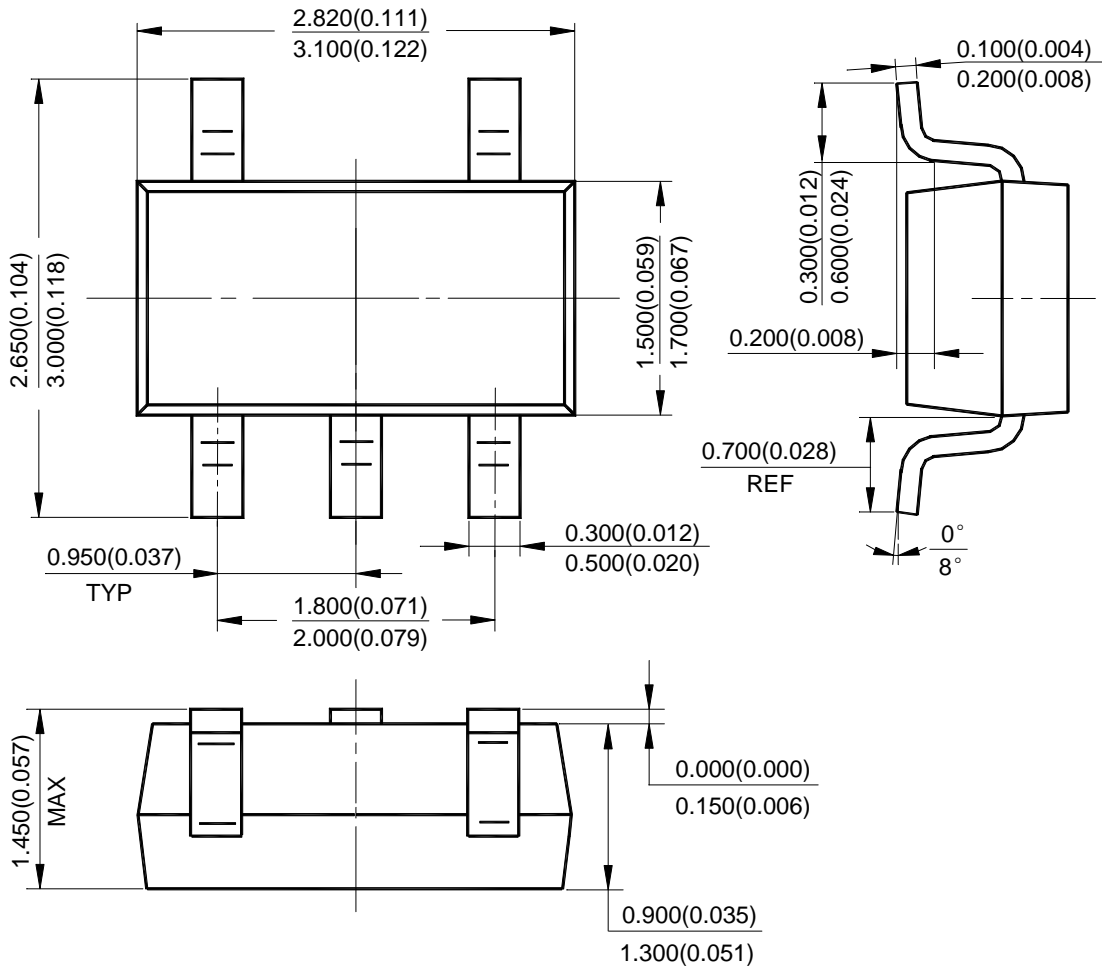

**Package Outline Dimensions** (All dimensions in mm(inch).) (continued)

Please see <http://www.diodes.com/package-outlines.html> for the latest version.

(2) Package Type: SO-8

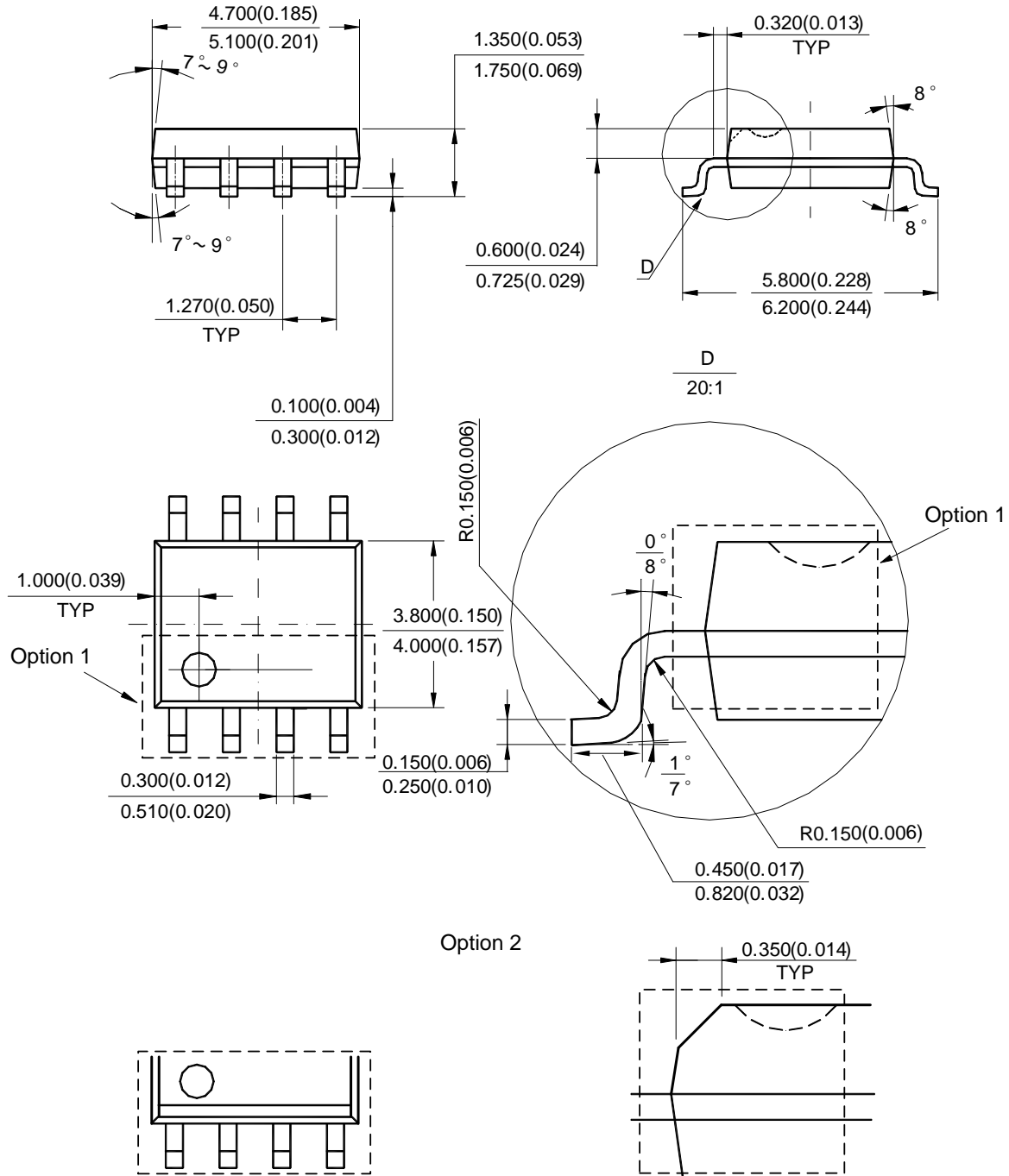

Note: Eject hole, oriented hole and mold mark is optional.

**Package Outline Dimensions** (All dimensions in mm(inch).) (continued)

Please see <http://www.diodes.com/package-outlines.html> for the latest version.

**(3) Package Type: MSOP-8**

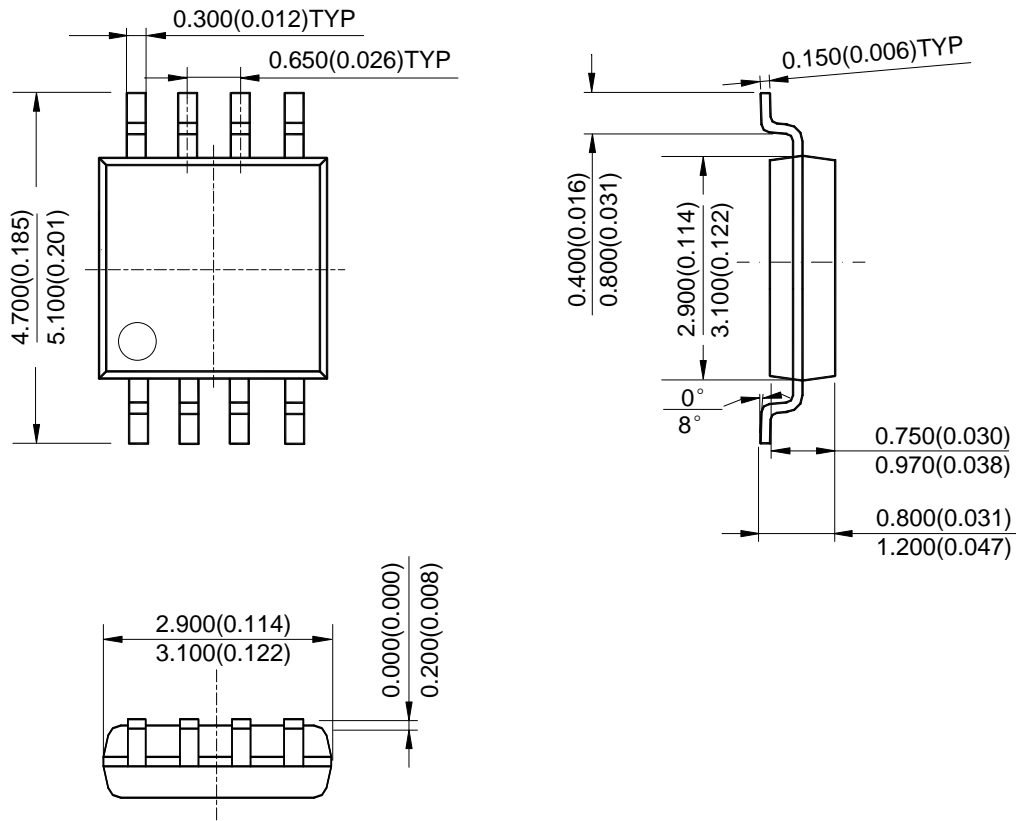

Note: Eject hole, oriented hole and mold mark is optional.

**Suggested Pad Layout**

Please see <http://www.diodes.com/package-outlines.html> for the latest version.

(1) Package Type: SOT25

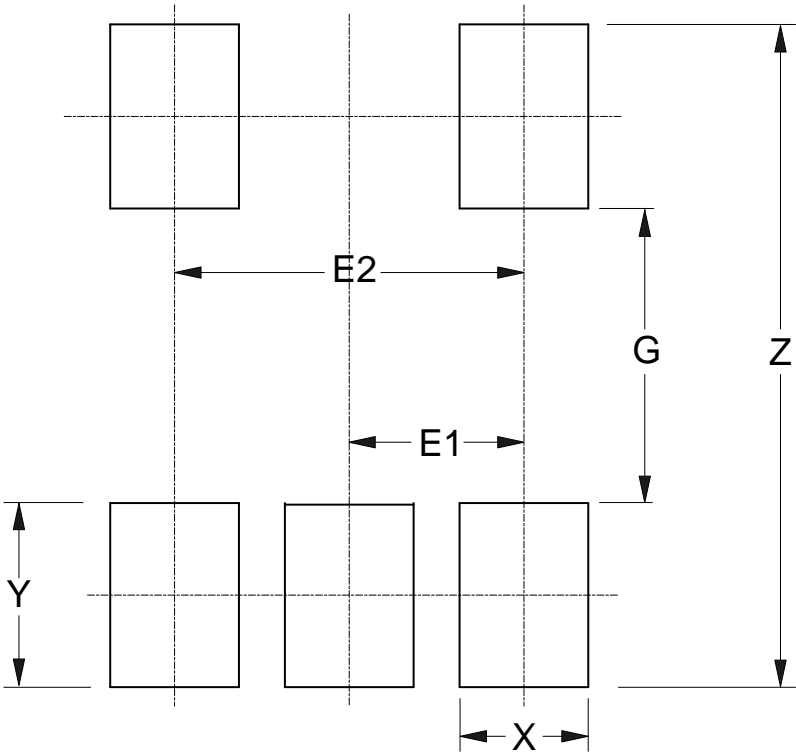

Dimensions	Z (mm)/(inch)	G (mm)/(inch)	X (mm)/(inch)	Y (mm)/(inch)	E1 (mm)/(inch)	E2 (mm)/(inch)
Value	3.600/0.142	1.600/0.063	0.700/0.028	1.000/0.039	0.950/0.037	1.900/0.075

**Suggested Pad Layout** (continued)

Please see <http://www.diodes.com/package-outlines.html> for the latest version.

(2) Package Type: SO-8

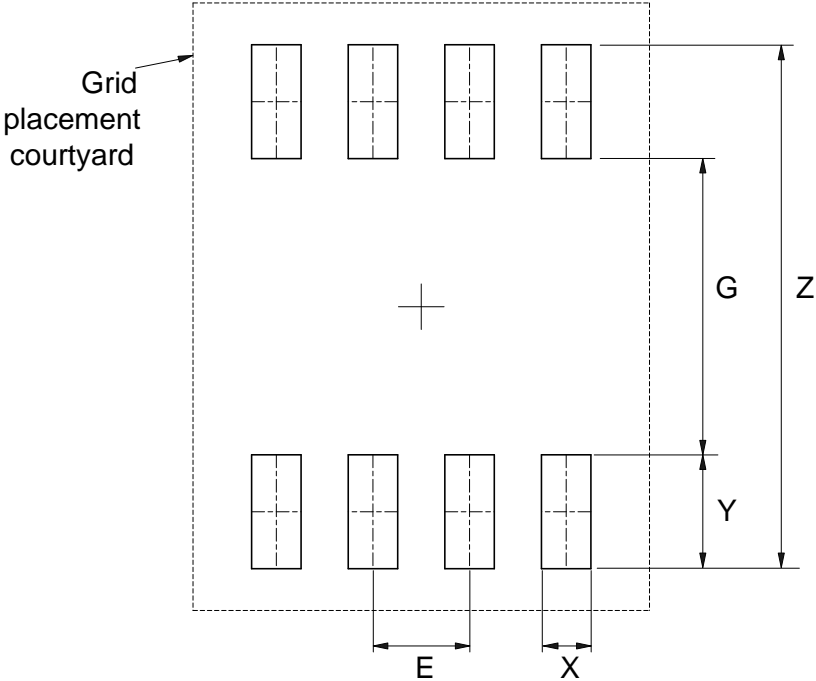

Dimensions	Z (mm)/(inch)	G (mm)/(inch)	X (mm)/(inch)	Y (mm)/(inch)	E (mm)/(inch)
Value	6.900/0.272	3.900/0.154	0.650/0.026	1.500/0.059	1.270/0.050

## Suggested Pad Layout (continued)

Please see <http://www.diodes.com/package-outlines.html> for the latest version.

### (3) Package Type: MSOP-8

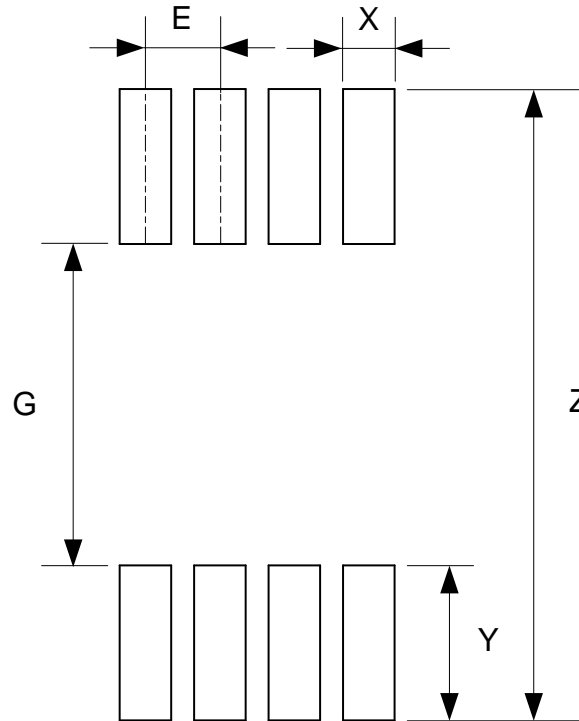

Dimensions	Z (mm)/(inch)	G (mm)/(inch)	X (mm)/(inch)	Y (mm)/(inch)	E (mm)/(inch)
Value	5.500/0.217	2.800/0.110	0.450/0.018	1.350/0.053	0.650/0.026

## Mechanical Data

### SOT25

- Moisture Sensitivity: Level 1 per J-STD-020
- Terminals: Finish – Matte Tin Plated Leads, Solderable per MIL-STD-202, Method 208
- Weight: 0.015 grams (Approximate)

### SO-8

- Moisture Sensitivity: Level 1 per J-STD-020
- Terminals: Finish – Matte Tin Plated Leads, Solderable per MIL-STD-202, Method 208
- Weight: 0.074 grams (Approximate)

### MSOP-8

- Moisture Sensitivity: Level 1 per J-STD-020
- Terminals: Finish – Matte Tin Plated Leads, Solderable per MIL-STD-202, Method 208
- Weight: 0.0246 grams (Approximate)

**IMPORTANT NOTICE**

1. DIODES INCORPORATED (Diodes) AND ITS SUBSIDIARIES MAKE NO WARRANTY OF ANY KIND, EXPRESS OR IMPLIED, WITH REGARDS TO ANY INFORMATION CONTAINED IN THIS DOCUMENT, INCLUDING, BUT NOT LIMITED TO, THE IMPLIED WARRANTIES OF MERCHANTABILITY, FITNESS FOR A PARTICULAR PURPOSE OR NON-INFRINGEMENT OF THIRD PARTY INTELLECTUAL PROPERTY RIGHTS (AND THEIR EQUIVALENTS UNDER THE LAWS OF ANY JURISDICTION).
2. The Information contained herein is for informational purpose only and is provided only to illustrate the operation of Diodes' products described herein and application examples. Diodes does not assume any liability arising out of the application or use of this document or any product described herein. This document is intended for skilled and technically trained engineering customers and users who design with Diodes' products. Diodes' products may be used to facilitate safety-related applications; however, in all instances customers and users are responsible for (a) selecting the appropriate Diodes products for their applications, (b) evaluating the suitability of Diodes' products for their intended applications, (c) ensuring their applications, which incorporate Diodes' products, comply the applicable legal and regulatory requirements as well as safety and functional-safety related standards, and (d) ensuring they design with appropriate safeguards (including testing, validation, quality control techniques, redundancy, malfunction prevention, and appropriate treatment for aging degradation) to minimize the risks associated with their applications.
3. Diodes assumes no liability for any application-related information, support, assistance or feedback that may be provided by Diodes from time to time. Any customer or user of this document or products described herein will assume all risks and liabilities associated with such use, and will hold Diodes and all companies whose products are represented herein or on Diodes' websites, harmless against all damages and liabilities.
4. Products described herein may be covered by one or more United States, international or foreign patents and pending patent applications. Product names and markings noted herein may also be covered by one or more United States, international or foreign trademarks and trademark applications. Diodes does not convey any license under any of its intellectual property rights or the rights of any third parties (including third parties whose products and services may be described in this document or on Diodes' website) under this document.
5. Diodes' products are provided subject to Diodes' Standard Terms and Conditions of Sale (<https://www.diodes.com/about/company/terms-and-conditions/terms-and-conditions-of-sales/>) or other applicable terms. This document does not alter or expand the applicable warranties provided by Diodes. Diodes does not warrant or accept any liability whatsoever in respect of any products purchased through unauthorized sales channel.
6. Diodes' products and technology may not be used for or incorporated into any products or systems whose manufacture, use or sale is prohibited under any applicable laws and regulations. Should customers or users use Diodes' products in contravention of any applicable laws or regulations, or for any unintended or unauthorized application, customers and users will (a) be solely responsible for any damages, losses or penalties arising in connection therewith or as a result thereof, and (b) indemnify and hold Diodes and its representatives and agents harmless against any and all claims, damages, expenses, and attorney fees arising out of, directly or indirectly, any claim relating to any noncompliance with the applicable laws and regulations, as well as any unintended or unauthorized application.
7. While efforts have been made to ensure the information contained in this document is accurate, complete and current, it may contain technical inaccuracies, omissions and typographical errors. Diodes does not warrant that information contained in this document is error-free and Diodes is under no obligation to update or otherwise correct this information. Notwithstanding the foregoing, Diodes reserves the right to make modifications, enhancements, improvements, corrections or other changes without further notice to this document and any product described herein. This document is written in English but may be translated into multiple languages for reference. Only the English version of this document is the final and determinative format released by Diodes.
8. Any unauthorized copying, modification, distribution, transmission, display or other use of this document (or any portion hereof) is prohibited. Diodes assumes no responsibility for any losses incurred by the customers or users or any third parties arising from any such unauthorized use.
9. This Notice may be periodically updated with the most recent version available at <https://www.diodes.com/about/company/terms-and-conditions/important-notice>

The Diodes logo is a registered trademark of Diodes Incorporated in the United States and other countries.  
All other trademarks are the property of their respective owners.  
© 2023 Diodes Incorporated. All Rights Reserved.

[www.diodes.com](http://www.diodes.com)