

## Hardware Version V1.5

## TMC5130-EVAL EVALUATION BOARD MANUAL

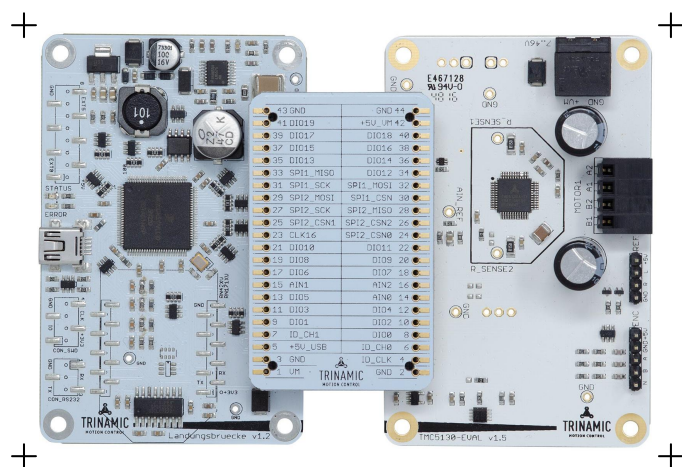

## DESCRIPTION

The TMC5130-EVAL is designed for evaluating all features of the TMC5130A-TA. The evaluation board is part of TRINAMIC's new user-friendly plug-in system for chip evaluation. Just connect the TMC5130-EVAL with LANDUNGSBRUECKE, the associated base board. Therefore, use the dedicated connector board, called ESELSBRÜCKE. ESELSBRÜCKE offers test points for every connector pin.

## TMC5130-EVAL EVALUATION BOARD

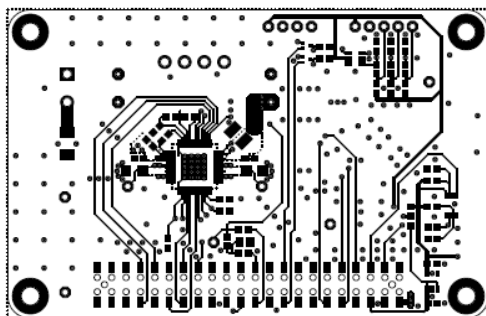

## TMC5130-EVAL FEATURES

- Single wire interface to CPU
- SPI interface to CPU
- Step/Dir interface with microstep interpolation MicroPlyer™
- Power connector
- Motor connector
- Retrofit option for encoder and reference switch connectors
- Multi-pin connector to base board
- Multiple test points

## TMCL-IDE 3.0 SOFTWARE

- TMCL-IDE 3.0 software allowing access to all registers
- Graphical view of position counter and motor velocity
- Additional tools for special features

## TMC5130 MAIN CHARACTERISTICS

- 2-phase bipolar stepper motors
- Drive capability up to 2A coil current
- Motion controller / SixPoint™ ramp
- Voltage range 4.75... 46V DC
- SPI & single wire UART
- Dual ABN encoder interface
- 2x reference switch input
- 256 microsteps per full step
- Full protection & diagnostics
- DcStep™ load dependent speed control
- StallGuard2™ high precision sensorless motor load detection
- CoolStep™ load dependent current control for energy savings up to 75%
- StealthChop™ for extremely quiet operation and smooth motion
- SpreadCycle™ high-precision chopper for best current sine wave form and zero crossing with additional chopSync2™
- Integrated current sense option
- Passive braking and freewheeling mode
- Small Size 9x9mm<sup>2</sup> TQFP48 package

### TRINAMICS UNIQUE FEATURES

**StallGuard2™** StallGuard2 is a high-precision sensorless load measurement using the back EMF on the coils. It can be used for stall detection as well as other uses at loads below those which stall the motor. The StallGuard2 measurement value changes linearly over a wide range of load, velocity, and current settings.

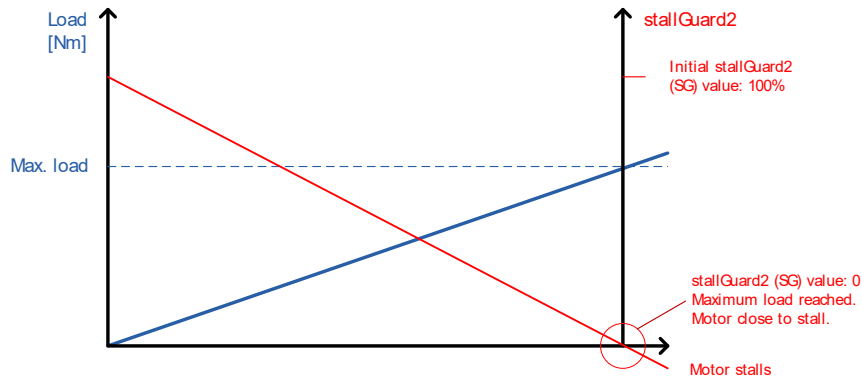

**CoolStep™** CoolStep is an automatic current scaling based on the load measurement via StallGuard2 adapting the required current to the load. Energy consumption can be reduced by as much as 75%. CoolStep allows substantial energy savings, especially for motors which see varying loads or operate at a high duty cycle. Even a constant-load application allows significant energy savings because CoolStep automatically enables torque reserve when required.

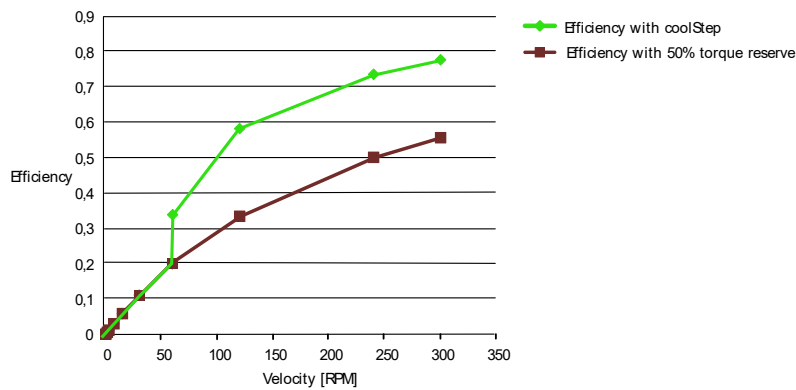

**DcStep™** DcStep is an automatic commutation mode for the stepper motor. It allows the stepper to run with its nominal velocity taken from the ramp generator as long as it can cope with the load. In case the motor becomes overloaded, it slows down to a velocity, where the motor can still drive the load. This way, the stepper motor never stalls and can drive heavy loads as fast as possible.

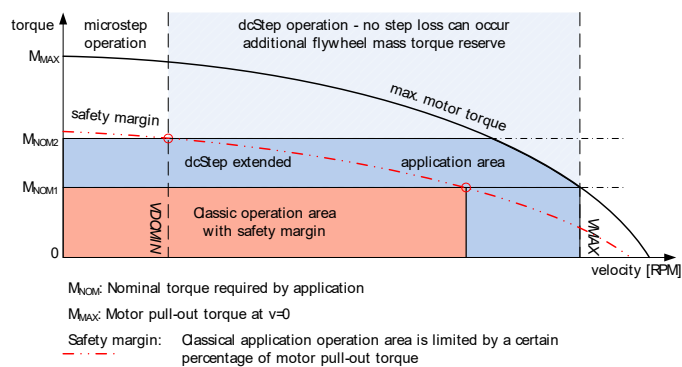

## Order Codes

The TMC5130-EVAL is a controller/driver board. It is part of the TRINAMICs evaluation board system. To have a complete operational system, the evaluation board needs to be connected to a baseboard with included microcontroller called LANDUNGSBRUECKE. Therefore, use ESELSBRÜCKE, a special connector board with test points.

Order codes	Description	Size of unit [cm]
TMC5130-EVAL-KIT	Evaluation board for TMC5130A-TA two phase motor controller/driver including LANDUNGSBRUECKE and ESELSBRÜCKE	12.6 x 8.5

**Table 1.1 Order Codes**

*Note*  
LANDUNGSBRUECKE and ESELSBRÜCKE are baseboard and connector board designed for universal use within TRINAMICs plug-in evaluation system. Both can be used in combination with other EVAL boards (designed to suit to the system).

## Table of Contents

1	Set-up and Features .....	5
2	TMC5130-EVAL-KIT Dimensions.....	7
2.1	Dimensions.....	7
2.1.1	Dimensions of TMC5130-EVAL and LANDUNGSBRUECKE .....	7
2.1.2	Dimensions of ESELSBRÜCKE .....	7
3	Evaluation Kit Connectors .....	8
3.1	TMC5130-EVAL Connectors and Test Points.....	8
3.1.1	Power Connector .....	8
3.1.2	Motor Connector .....	9
3.1.3	Encoder Connector .....	9
3.1.4	Reference Switch Connector .....	9
3.1.5	Test Points (in addition to ESELSBRÜCKE) .....	9
3.2	ESELSBRÜCKE: SPI Interface, I/Os, and Test Points .....	10
3.3	LANDUNGSBRUECKE: Connectors on the Base Board.....	11
3.3.1	USB Connector.....	11
3.3.2	RS232 Connector (not soldered) .....	12
4	System Status LEDs .....	12
5	Operational Ratings of the TMC5130-EVAL-KIT .....	13
6	Getting Started.....	14
6.1	Starting up.....	15
6.1.1	Checking the Status of LANDUNGSBRUECKE and TMC5130-EVAL .....	16
6.2	Velocity Mode .....	17
6.3	Positioning Mode .....	18
6.4	Direct Mode Dialogue .....	19
6.5	CoolStep and StallGuard2 .....	20
6.6	TMCL Creator .....	20
7	Life Support Policy.....	21
8	Revision History.....	22
8.1	Firmware Revision .....	22
8.2	Document Revision .....	22
9	References .....	22

# 1 Set-up and Features

The TMC5130-EVAL is part of an evaluation board system. Offering a very convenient handling for chip evaluation, TRINAMIC developed a plug-in system which consists of three parts: LANDUNGSBRUECKE, ESELSBRÜCKE, and TMC5130-EVAL.

## LANDUNGSBRUECKE

LANDUNGSBRUECKE is a baseboard. It is equipped with an ARM Cortex-M4 microcontroller (and EEPROM) and controls the TMC5130. The FLASH memory of the microcontroller holds a program for configuration of the TMC5130. Further, LANDUNGSBRUECKE controls the communication with the PC via USB or RS232 interface. For connecting LANDUNGSBRUECKE to the PC, use the mini-USB interface connector on the board. Additionally, it is possible to communicate via the RS232 interface. Therefore, a connector can be soldered with little effort.

## ESELSBRUECKE

This small board forwards signals from LANDUNGSBRUECKE to TMC5130-EVAL. ESELSBRÜCKE provides test points for several measurements.

## TMC5130-EVAL

This evaluation board is designed for testing all features of the TMC5130. The TMC5130 motion controller and driver IC is an intelligent power component interfacing between the CPU and a stepper motor. Several motion commands can be easily executed. The TMC5130 offers a number of unique enhancements which are enabled by the system-on-chip integration of driver and controller. The SixPoint ramp generator of the TMC5130 uses DcStep, CoolStep, and StallGuard2 automatically in order to optimize every motor movement.

Using the TMCL-IDE V3.0 software tool, all features of the TMC5130A-TA can be tried out.

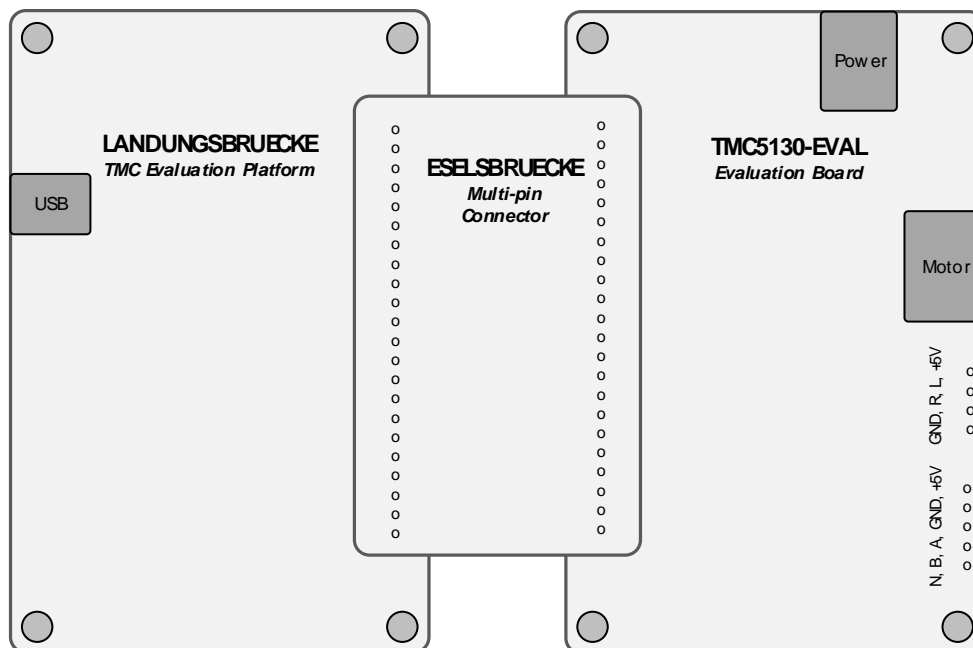

Figure 1.1 TMC5130-EVAL plug-in system set-up

## **TMC5130-EVAL FEATURES**

### ***Integrated Motion Controller***

- Linear six-point ramp generator.
- Motion profile calculation in real-time.
- On the fly alteration of motor parameters (e.g. position, velocity, acceleration).

### ***Integrated Motor Driver***

- Up to 256 microsteps per full step.
- High-efficient operation, low power dissipation.
- Dynamic current control.
- StallGuard2 feature for stall detection.
- CoolStep feature for reduced power consumption and heat dissipation.
- DcStep feature for high velocity drive (related to the motor load).
- stealthChop chopper for noiseless operation and smooth motion.
- Integrated current sense option.
- Passive braking and freewheeling mode.
- spreadCycle chopper or classic chopper.

### ***Electrical Data***

- Motor current: up to 2x 1.1 A RMS nominal motor current.
- Supply voltage: +4.5V... +20V DC operating voltage.

### ***Interfaces***

- USB (type B)
- RS232 (connector can be retrofitted)
- Native SPI™ of the TMC5130
- Encoder interface
- Reference switch inputs
- Access to all signals of the TMC5130

### ***Motor Type***

- Two phase bipolar stepper motor

### ***Safety Features***

- Overcurrent
- Short to GND
- Undervoltage protection
- Integrated diagnostics

### ***Software***

- PC software allowing access to all registers.
- Graphical view of position counter and motor velocity.
- Special tools for unique features.

## 2 TMC5130-EVAL-KIT Dimensions

### 2.1 Dimensions

#### 2.1.1 Dimensions of TMC5130-EVAL and LANDUNGSBRUECKE

Board dimensions of both modules are 85mm x 55mm. There are four mounting holes suitable for M3 screws.

TMC5130-EVAL maximum component height (above PCB level) without mating connectors: 12mm.

LANDUNGSBRUECKE maximum component height (above PCB level) without mating connectors: 11mm.

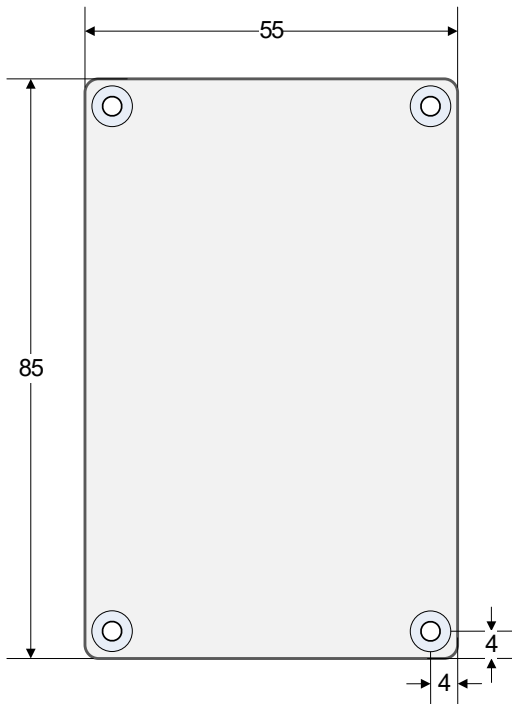

Figure 2.1 Dimensions: TMC5130-EVAL and LANDUNGSBRUECKE

#### 2.1.2 Dimensions of ESELSBRÜCKE

Board dimensions are 61mm x 38mm. Maximum component height (above PCB level) without mating connectors is 9.4mm.

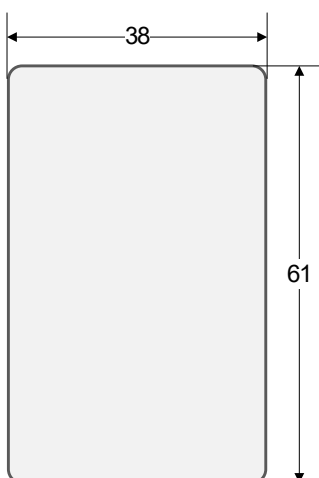

Figure 2.2 Dimensions of ESELSBRÜCKE

## 3 Evaluation Kit Connectors

### 3.1 TMC5130-EVAL Connectors and Test Points

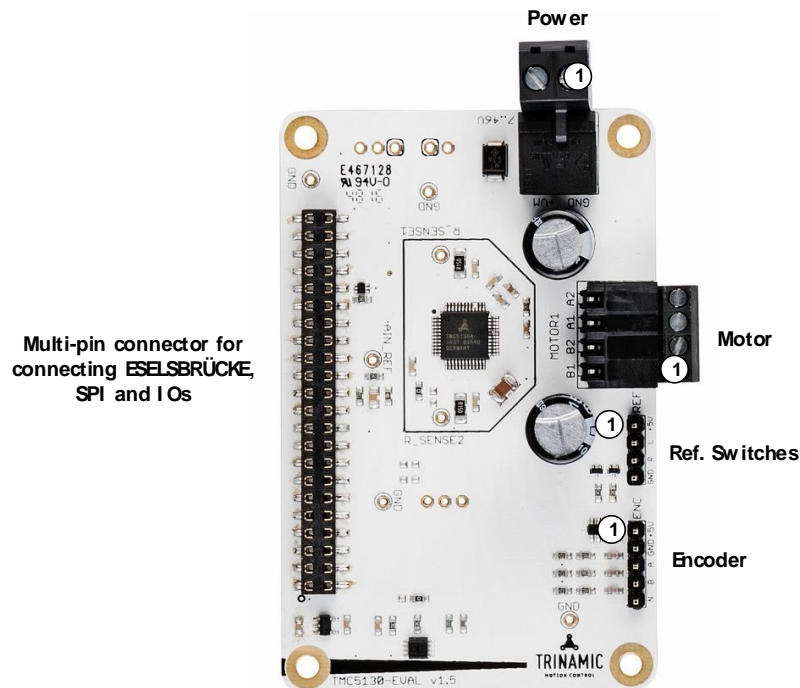

Figure 3.1 Connectors of TMC5130-EVAL

CONNECTORS OF TMC5130-EVAL		
Label (Key)	Connector type	Mating connector type
Power	RIA 330-02, 2 pol., 5mm pitch, shrouded header	RIA 349-2, screw type terminal block, pluggable, centerline 5 mm / 0.197 inches, wire entry parallel to plug direction
Motor	RIA 182-04, 4 pol., 3.5mm pitch, shrouded header	RIA 169-04, screw type terminal block, pluggable, centerline 3.5 mm / 0.138 inches, wire entry parallel to plug direction
SPI and IOs	2 x 22 pol., 2.54mm pitch, pluggable female connector	2 x 22 pol., 2.54mm pitch, pluggable male connector
Reference switches	Standard male 4 pin connector, one row, 2.54mm pitch	Standard female 4 pin connector, one row, 2.54mm pitch
Encoder	Standard male 5 pin connector, one row, 2.54mm pitch	Standard female 4 pin connector, one row, 2.54mm pitch

Table 3.1 Connectors

#### 3.1.1 Power Connector

Pin	Label	Description
1	GND	Power supply and signal ground
2	+VM	Operational voltage: +7... +46V DC

Table 3.2 Power connector 2



### 3.1.2 Motor Connector

Pin	Label	Description
1	O1B1	Motor coil B
2	O1B2	Motor coil B
3	O1A1	Motor coil A
4	O1A2	Motor coil A

Table 3.3 Motor connector

### 3.1.3 Encoder Connector

Pin	Label	Description
1	+5V	+5V power supply
2	GND	System and module ground
3	ENCA	Input A for incremental encoder
4	ENCB	Input B for incremental encoder
5	ENCN	Zero channel for incremental encoder

Table 3.4 Encoder connector

### 3.1.4 Reference Switch Connector

Pin	Label	Description
1	+5V	+5V power supply
2	REF_L	Left reference switch
3	REF_R	Right reference switch
4	GND	System and module ground

Table 3.1 Reference switch connector

### 3.1.5 Test Points (in addition to ESELSBRÜCKE)

Apart from ESELSBRÜCKE the evaluation system provides test points on the TMC5130-EVAL.

TEST POINTS ON TMC5130-EVAL	
Label	Description
R_SENSE1	Sense resistor motor coil A
R_SENSE2	Sense resistor motor coil B
GND	Signal and system ground
AIN_REF	Analog reference voltage of AIN_REF_SW (internal current sensing) or of AIN_REF_PWM (analog current scaling using microcontroller PWM).
REFL_STEP	Left reference input or STEP input (depends on settings of SD_MODE and SPI_MODE bits). Note that this test point is directly connected to the TMC5130.
REFR_DIR	Right reference input or DIR input (depends on settings of SD_MODE and SPI_MODE bits). Note that this test point is directly connected to the TMC5130.

Figure 3.2 Test points on TMC5130-EVAL

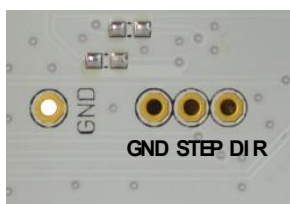
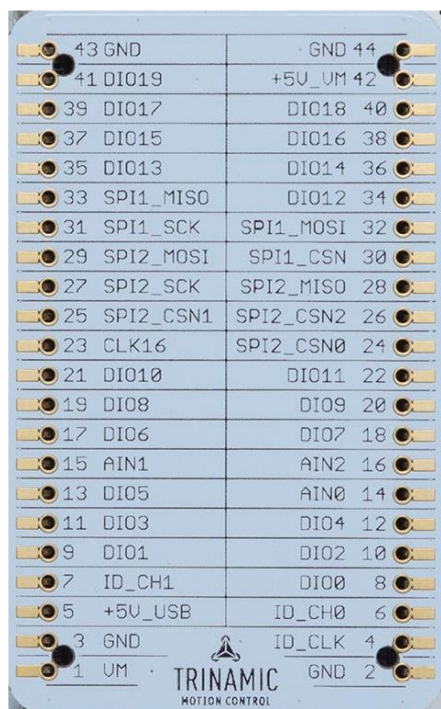

Figure 3.3 Test points for GND, REFL\_STEP, and REFR\_DIR

## 3.2 ESELSBRÜCKE: SPI Interface, I/Os, and Test Points

The multi-pin connector ESELSBRÜCKE is used to connect LANDUNGSBRUECKE and TMC5130-EVAL. Pin connections include the SPI interface, supply voltages, and IOs like driver enable (DRV\_ENN), position compare (PP), interrupts (INT), and status flags. ESELSBRÜCKE offers test points for several measurements.



**Avoid displacing ESELSBRÜCKE when operating! Otherwise LANDUNGSBRUECKE and/or the TMC5130-EVAL can be damaged!**

Figure 3.4 ESELSBRÜCKE: pin assignment

Pin	Label ESELSBRÜCKE	Label TMC5130-EVAL	Description
1	+VM	+VM	Operational voltage: +4.5... 20V DC. LANDUNGSBRUECKE: connected to $\mu$ C (VM_MEAS) for voltage measurement.
2	GND	GND	System and module ground.
3	GND	GND	System and module ground.
4	ID_CLK	ID_CLK	LANDUNGSBRUECKE: clock pulse test point. Timer mode 3 (general purpose) and timer mode 8 (advanced control) of the microcontroller are used. Both capture 4 channels.
5	+5V_USB	VCC_IO	Used to generate 3.3V (VCCIO).
6	ID_CH0	ID_CH0	ID channel 0. Used for automatic module detection.
7	ID_CH1	-	LANDUNGSBRUECKE: ID_CH1. <i>Not used with TMC5130-EVAL.</i>
8	DIO0	DRV_ENN	Enable (not) input for driver (tie to GND). Switches off all motor outputs (set high for disable).
9	DIO1	ENCN_DCO	Encoder N-channel or DcStep ready output when SD_MODE=1.
10	DIO2	ENCA_DCIN	Encoder A-channel or DcStep gating input for axis synchronization when SD_MODE=1.
11	DIO3	ENCB_DCEN	Encoder B-channel or DcStep enable input when SD_MODE=1.
12	DIO4	-	LANDUNGSBRUECKE: analogue inputs. <i>Not used with TMC5130-EVAL.</i>
13	DIO5	-	
14	AIN0	-	
15	AIN1	-	
16	AIN2	-	
17	DIO6	REF_L	Left reference switch signal
18	DIO7	REF_R	Right reference switch signal
19	DIO8	-	LANDUNGSBRUECKE: digital IOs. <i>Not used with TMC5130-EVAL.</i>

Pin	Label ESELSBRÜCKE	Label TMC5130-EVAL	Description
20	DIO9	-	
21	DIO10	AIN_IREF_SW	Optional current reference when using TMC5130 internal current sensing (sense resistors bridged).
22	DIO11	AIN_IREF_PWM	Analog scaling of motor current using microcontroller PWM.
23	CLK16	CLK	CLK input 16MHz.
24	SPI2_CSNO	-	LANDUNGSBRUECKE: SPI2 with three CS lines for driver module. Can be used as digital IOs. <i>Not used with TMC5130-EVAL.</i>
25	SPI2_CSN1	-	
26	SPI0_SCN2	-	
27	SPI2_SCK	-	
28	SPI2_SDO	-	
29	SPI2_SDI	-	
30	SPI1_CSN	CSN/IO0	Chip select input of SPI interface, programmable IO in UART mode
31	SPI1_SCK	SCK/IO1	Serial clock input of SPI interface, programmable IO in UART mode
32	SPI1_SDI	SDI/IO2	Data input of SPI interface, programmable IO in UART mode
33	SPI1_SDO	SDO/IO3	Data output of SPI interface (Tristate, enabled with CSN=0), programmable IO in UART mode
34	DIO12	-	LANDUNGSBRUECKE: reference switches and end switches. Can be used as digital IOs. <i>Not used with TMC5130-EVAL.</i>
35	DIO13	-	
36	DIO14	SWSEL	Single wire interface selection input. Tie high for use of single wire interface.
37	DIO15	SWP_DIAG1	Single wire IO (positive) when SWSEL=1, otherwise diagnostics output DIAG1. Interrupt.
38	DIO16	SWN_DIAG0	Single wire IO (negative) when SWSEL=1, otherwise diagnostics output DIAG0. Interrupt or STEP output in motion controller mode.
39	DIO17		LANDUNGSBRUECKE: reference switches and end switches. Can be used as digital IOs. <i>Not used with TMC5130-EVAL.</i>
40	DIO18		
41	DIO19		
42	+5V...VM	-	+5V supply. Only available when VM applied, 700mA.
43	GND	GND	System and module ground
44	GND	GND	System and module ground

Table 3.5 ESELSBRÜCKE pinning

### 3.3 LANDUNGSBRUECKE: Connectors on the Base Board

Please find information about the SPI interface and I/O connector ESELBRÜCKE in chapter 3.1.5. Here, only the interface connectors are mentioned.

Label (Key)	Connector type	Mating connector type
USB (X1)	Mini USB, type B, 5 pol., female	Mini USB, type B, 5 pol., male
SPI and IOs (Interface)	2 x 22 pol., 2.54mm pitch, pluggable female connector	2 x 22 pol., 2.54mm pitch, pluggable male connector
RS232 (Con_RS232)	not soldered	

Table 3.6 Connectors on the base board

#### 3.3.1 USB Connector

Pin	Label	Description
1	+5V	+5V supply from host
2	USB-	Differential USB bus
3	USB+	Differential USB bus
4	GND	System and module ground
5	GND	System and module ground

Table 3.7 USB connector

### 3.3.2 RS232 Connector (not soldered)

Pin	Label	Description
1	GND	RS232 signal and system ground
2	RXD	Received data line
3	TXD	Transmitted data line

Table 3.8 RS232 connector

## 4 System Status LEDs

LANDUNGSBRUECKE has two LEDs. The green STATUS LED flashes constantly per default and indicates normal operation of the board. The red ERROR LED only lights up if an error occurred.



Figure 4.1 LEDs

#### LEDs of TMC5130-EVAL

Label	Color	Description
Status LED	green	Heartbeat of the module. Flashes constantly per default.
Error LED	red	Lights up in case of dysfunction, e.g., if VM is not available.

Table 4.1 LEDs

## 5 Operational Ratings of the TMC5130-EVAL-KIT

The operational ratings shown below should be used as design values. The maximum power supply current depends on the used motors and the supply voltage.

Do not exceed the maximum values during operation! Otherwise the TMC5130 will be damaged!

Symbol	Parameter	Min	Typ	Max	Unit
VM	Power supply voltage for operation	7	24	46	V
VCCIO	Digital power supply (for external microcontroller)		3.3		V
+5V	Output of internal switch regulator		5	5.1	V
ISUPPLY	Power supply current		0.5... 1.5	2	A
T <sub>ENV</sub>	Environment temperature at rated current (no forced cooling required)		20°C		°C

**Table 5.1 General operational ratings of the module**

## 6 Getting Started

### YOU NEED

- TMC5130-EVAL
- LANDUNGSBRUECKE
  - Firmware v3.06 or higher
- ESELSBRÜCKE
- Stepper motor (e.g. QSH4218)
- USB interface
- Nominal supply voltage +24V DC (+7... +46V DC)
- Latest TMCL-IDE V3.0 and PC
- Cables for interface, motors, and power

### PRECAUTIONS

- Do not mix up connections or short-circuit pins.
- Avoid bounding I/O wires with motor wires.
- Do not exceed the maximum power supply of +46V DC!
- Do not connect or disconnect the motor while powered!
- START WITH POWER SUPPLY OFF!

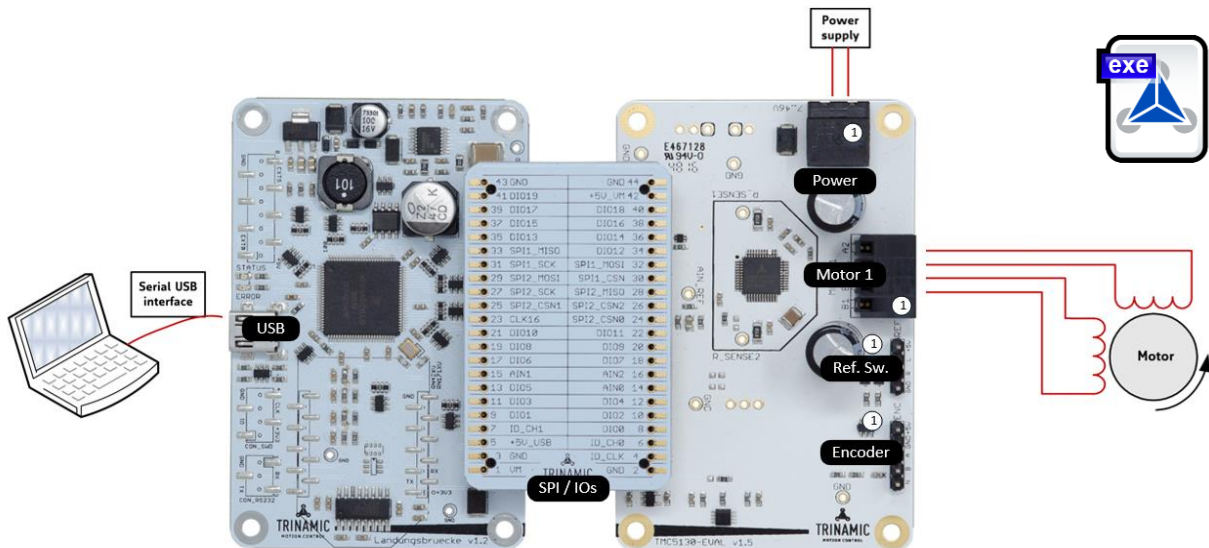

Figure 6.1 Getting started

### USB BUS POWERED MODE FOR CONFIGURATION

The TMC5130-EVAL-KIT supports both, USB self powered operation (when an external power is supplied via the power supply connector on the TMC5130-EVAL) and USB bus powered operation (only the USB interface is connected to the PC). On-board digital core logic will be powered via USB in case no other supply is connected. The digital core logic comprehends the microcontroller itself and also the EEPROM. The *USB bus powered operation mode* has been implemented to enable configuration, parameter settings, read-outs, etc. by just connecting an USB cable between module and host PC.

Motor movements are not possible in USB bus powered operation mode. Therefore, connect the power connector and change to *USB self powered operation mode*.

## 6.1 Starting up

1. Download the TMCL-IDE 3.0 from [www.trinamic.com](http://www.trinamic.com) and install it. Afterwards, the TMCL-IDE opens up automatically.
2. Connect the USB interface. Now, the software guides you through the installation of a virtual COM port for the USB interface.

*It is necessary to allow software access. Do not interrupt the process. Otherwise the automatic setup is not possible.*

If there are problems related to communication, connect the USB interface directly to your PC (without a USB-hub). In case the following error window appears on the screen, just unplug LANDUNGSBRUECKE and plug the USB connection again. Thereafter, everything should work.

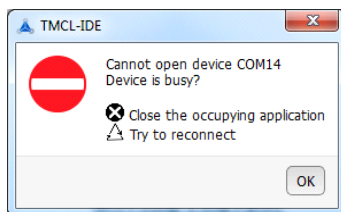

### Note:

*Usually, the virtual COM port becomes installed automatically. If the automatic device detection does not work for any reason, e.g., a problem with the windows software, install it manually.*

Figure 6.2 Error window

The TMCL-IDE includes a dialogue for diagnostic tasks. Further, the dialogue provides an overview of the connected motion controller and driver chips. Thus, a window pops up immediately after connecting the evaluation kit the first time. The window shows the actual status of the connections. The second tab of the dialogue offers the possibility to choose basic settings or to reset the module to factory defaults.

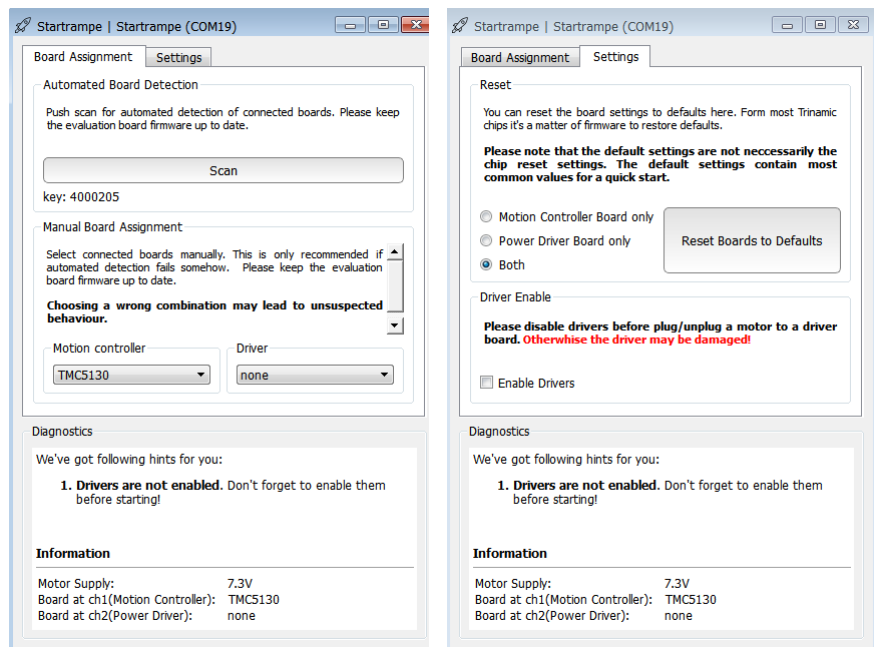
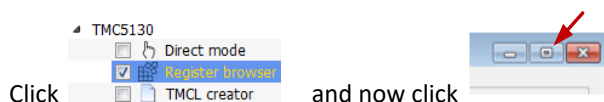

Figure 6.3 LANDUNGSBRUECKE dialogue

3. The TMCL-IDE 3.0 needs room to show all important information and to provide a good overview. Therefore, arrange the main window related to your needs. We recommend using full screen. For evaluation boards it is essential to have access to the registers. Therefore open up the *Register Browser* (left side). For a better view click top right on the normal icon to get a big register browser window.



Now, choose a maximum current setting for your motor (IRUN). For QSH4218, e.g., an absolute maximum setting of 22 is suitable. For a cooler QSH4218 motor choose 20. For setting the maximum current to a desired value, choose *IRUN* in the *All Registers* area and change the value on the right side of the window (refer to Figure 6.4). The default settings of the module are mean values which should be adjusted in relation to the connected motor.

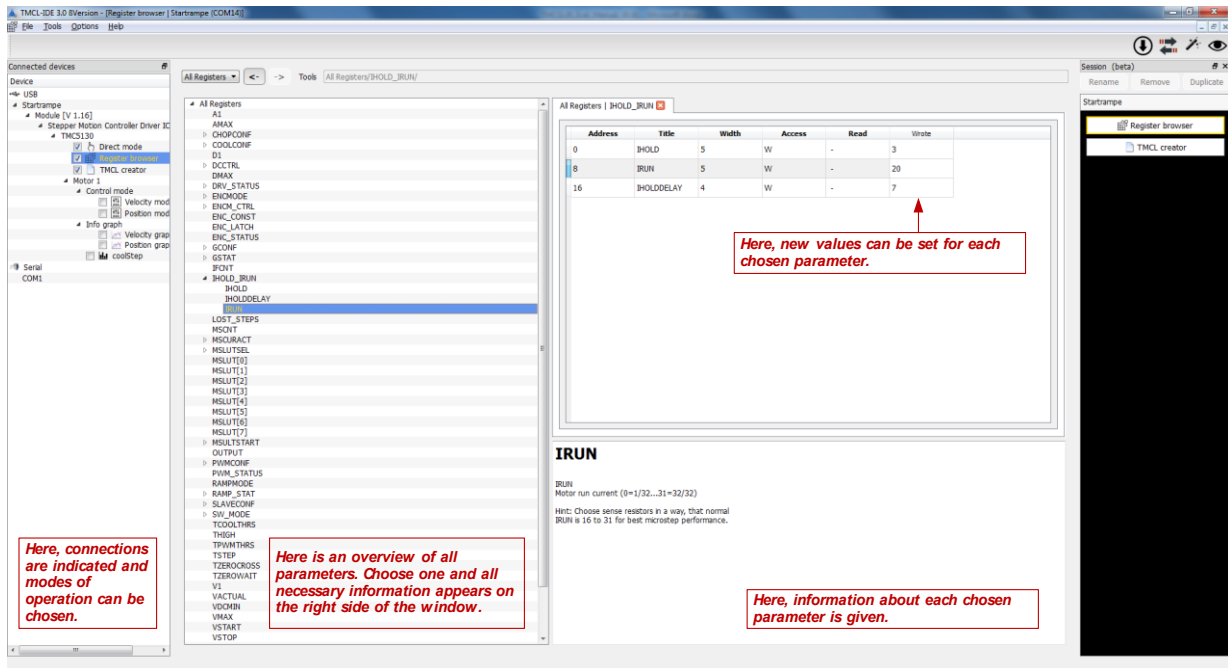
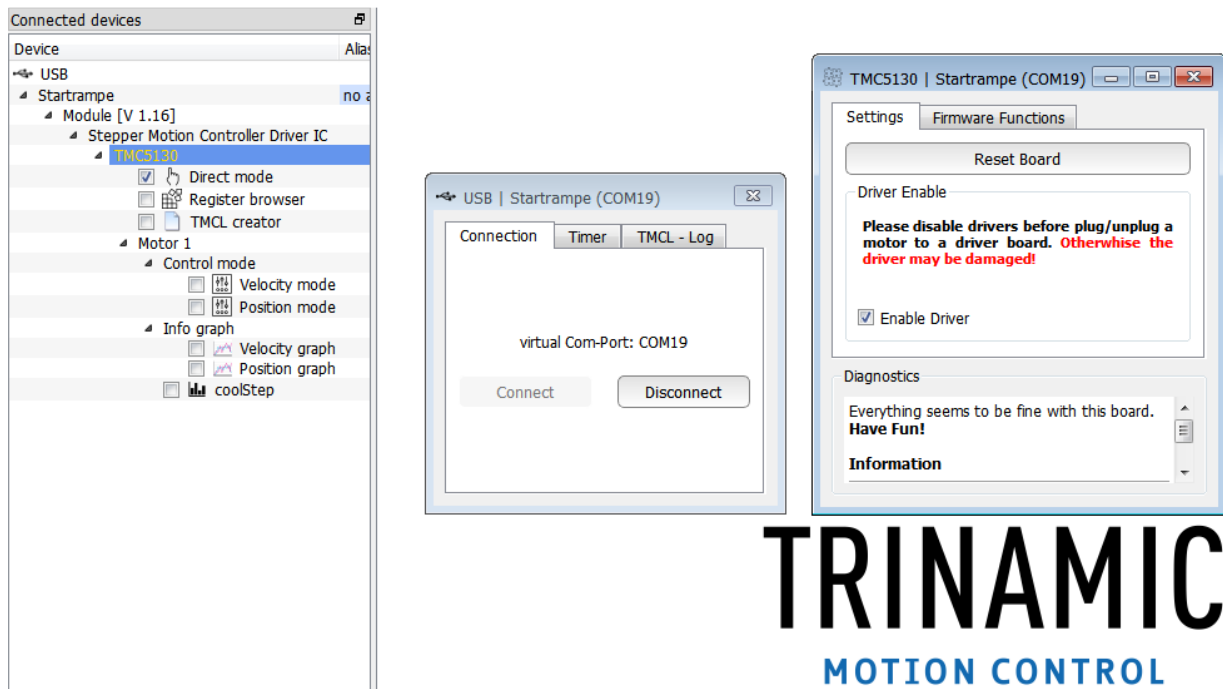

Figure 6.4 Main window with registers dialogue. The screenshot shows how to change IRUN.

- After selecting a value for IRUN, connect the motor and the power supply. For QSH4218 24V are recommended. Turn power ON. The green LED for the heartbeat (STATUS) flashes and the red LED for ERROR is off. The motor is powered but in standstill now. In case the ERROR LED glows, check your power supply again.

### 6.1.1 Checking the Status of LANDUNGSBRUECKE and TMC5130-EVAL

In case it is desired to check if the communication is established, the driver enabled, and the software correctly installed, click on *LANDUNGSBRUECKE* respectively *TMC5130* on the left side of the main window. Thereafter, the related small dialogues will pop up and provide information.





### Note

In order to achieve good settings it is necessary to work using the TMC5130 datasheet. The register browser of the TMCL-IDE offers helpful information about any parameter which is selected. But the list is alphabetically. Beyond that, the datasheet explains concepts and ideas which are basically for understanding how the registers are linked together and which setting will fit for which kind of application.

For getting more familiar with the evaluation kit in the beginning of your examinations, drive the motor using velocity mode and/or positioning mode first.

Beyond this, the direct mode function can be used. This way, TMCL commands can be sent to the evaluation board system. The direct mode dialogue is designed for TRINAMICs board level solutions and not mainly for evaluation board systems.

## 6.2 Velocity Mode

For moving the motor in velocity mode set two ticks on the left side of the main window to open the velocity mode dialogue and the velocity graph. Thereafter, choose a target velocity and an acceleration value and click on one arrow (increasing the position counter or decreasing it) for sending the command to the evaluation system.

*Please note that you get a better value report on the velocity graph if the register browser has been closed before.*

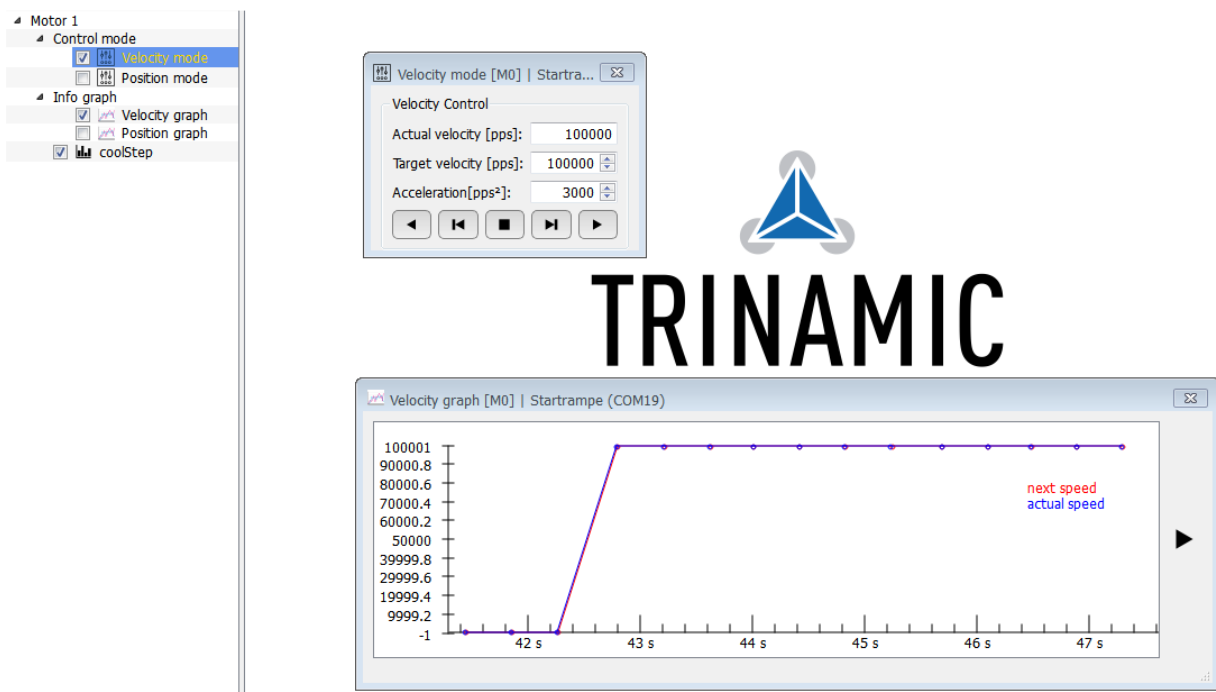

Figure 6.5 Driving the motor in velocity mode

## 6.3 Positioning Mode

For moving the motor in positioning mode, set two ticks on the left side of the main window in order to open the positioning mode dialogue and the position graph. Thereafter choose settings for

- maximum velocity,
- acceleration,
- deceleration,
- start velocity (can be 0),
- acceleration A1,
- velocity V1,
- deceleration D1, and
- stop velocity (not less than 1)

*Please note that the default deceleration D1 value has to be changed before moving because it is too high.*

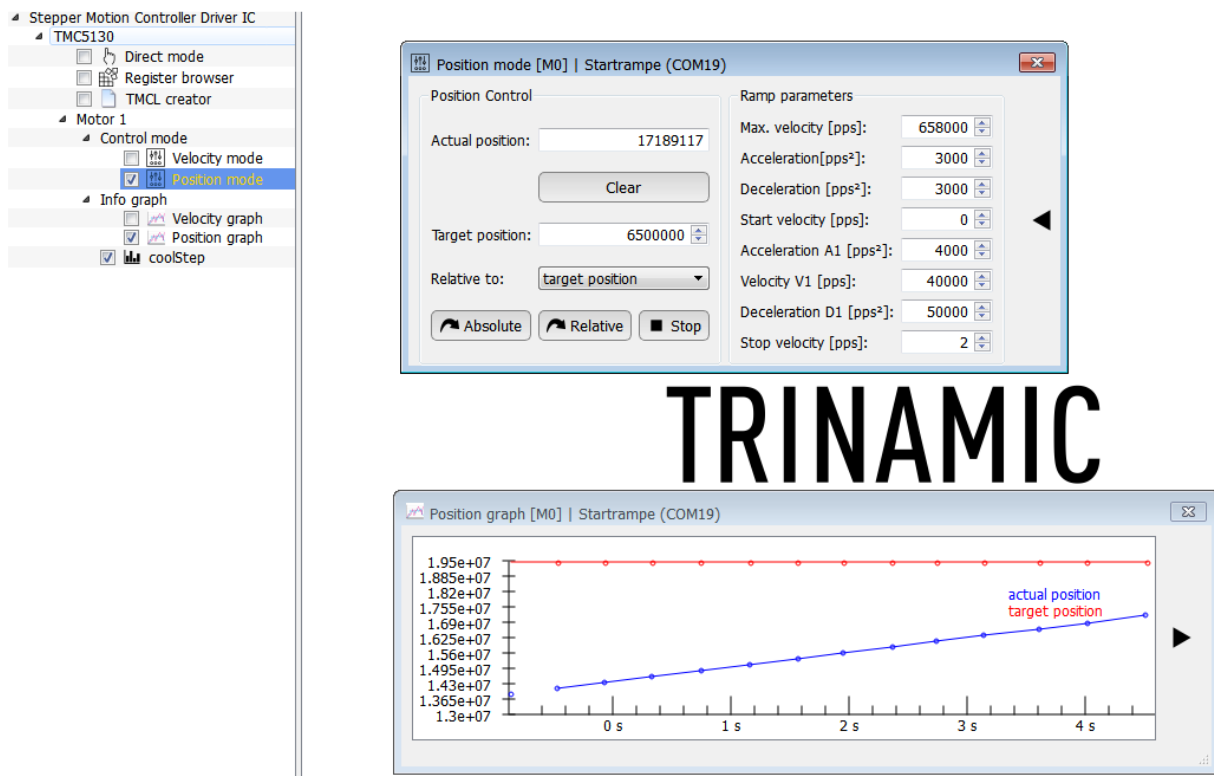

**Figure 6.6 Driving the motor in positioning mode**

The motor can be driven relatively or absolutely to the target position or to the actual position. If the desired position has been reached the motor stops using the deceleration parameters.

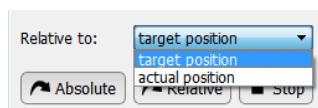

**Figure 6.7 Basis of movement**

## 6.4 Direct Mode Dialogue

For driving the motor in direct mode, set a tick on the left side of the main window. Now, the direct mode dialogue window pops up. The direct mode is used to issue commands and create complete programs. The handling of these TMCL-IDE commands is easy, but for evaluating the TMC5130 the other modes of operation and the direct register access via the register browser may be better, because the register access is not visible in direct mode.

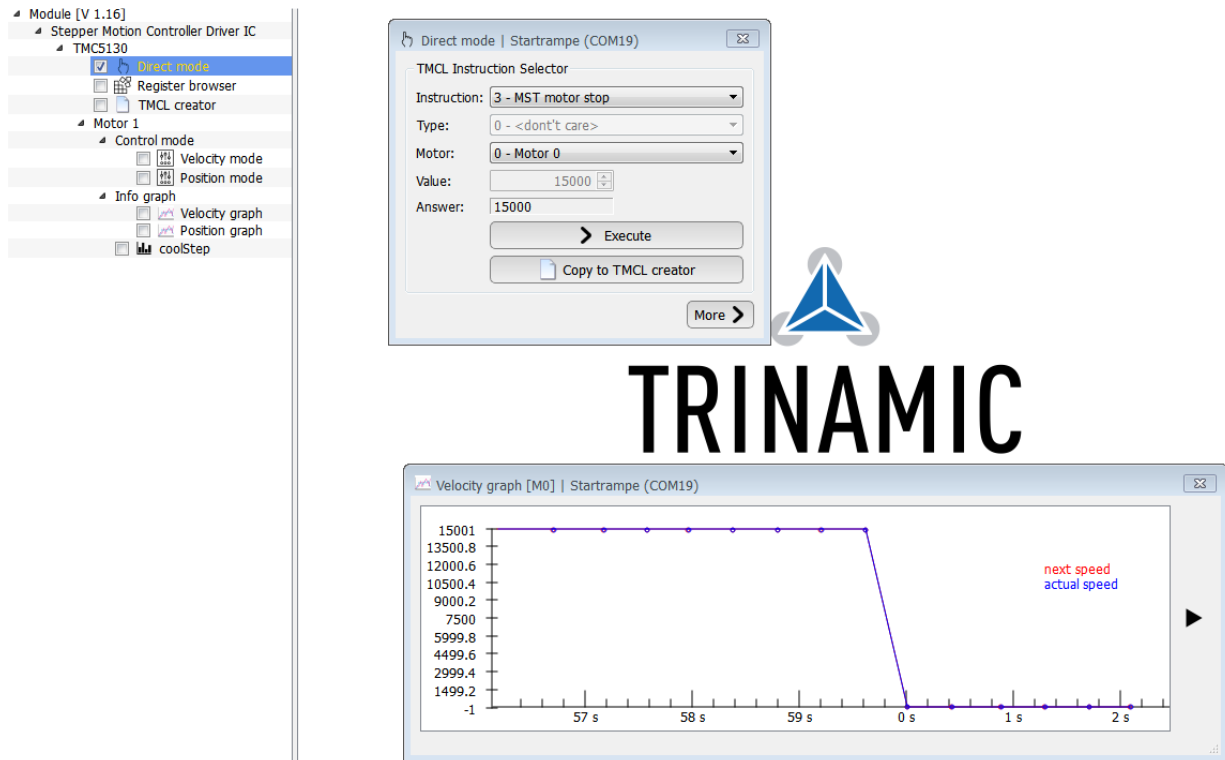

Figure 6.8 How to use direct mode.

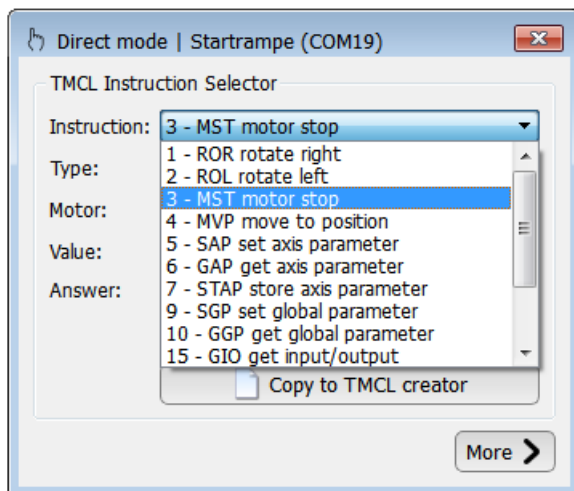

Figure 6.9 Selecting a command in direct mode

## 6.5 CoolStep and StallGuard2

This dialogue can be used to set StallGuard2 and CoolStep parameters and to read out actual motor current values as well as the StallGuard values. Choose a StallGuard threshold to use StallGuard2. With a tick at *filter enable* reading out the values gets more comfortable. The dialogue offers three tabs for StallGuard2, CoolStep and a display of TMCL commands which can be copied to the TMCL creator.

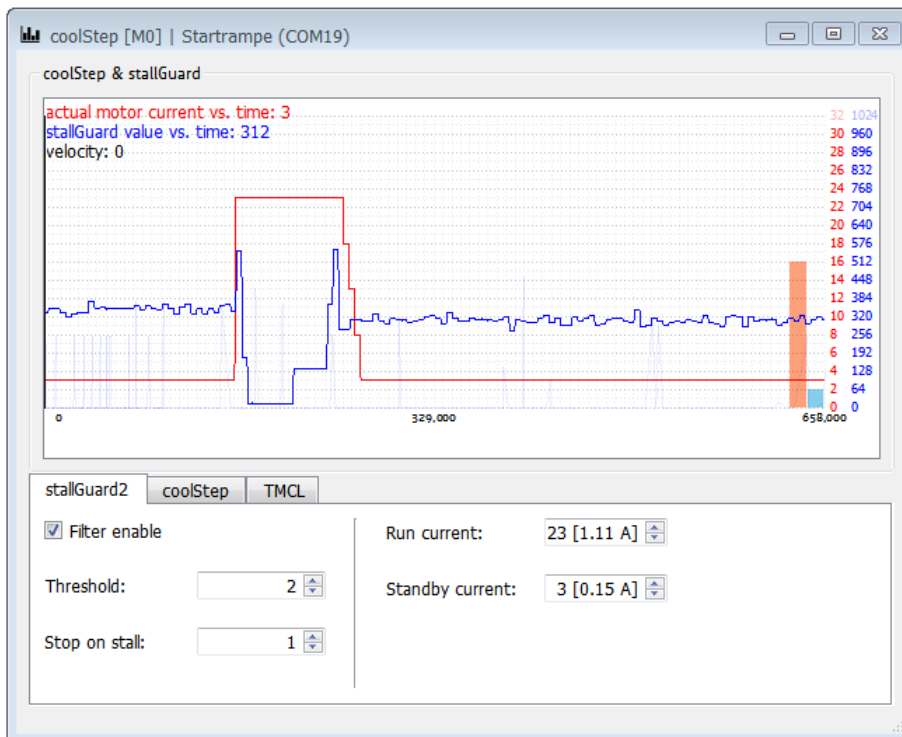

Figure 6.10 CoolStep and StallGuard2 dialogue

## 6.6 TMCL Creator

The TMCL creator is a tool for writing programs which can be loaded into the module in order to drive autonomously afterwards.

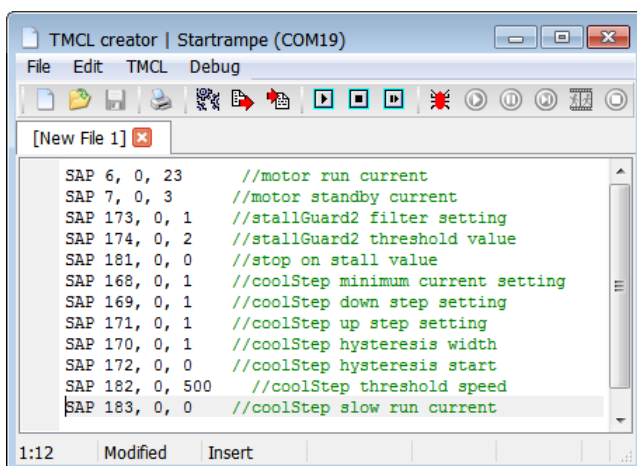

Figure 6.11 TMCL creator

## 7 Life Support Policy

TRINAMIC Motion Control GmbH & Co. KG does not authorize or warrant any of its products for use in life support systems, without the specific written consent of TRINAMIC Motion Control GmbH & Co. KG.

Life support systems are equipment intended to support or sustain life, and whose failure to perform, when properly used in accordance with instructions provided, can be reasonably expected to result in personal injury or death.

© TRINAMIC Motion Control GmbH & Co. KG 2019

Information given in this data sheet is believed to be accurate and reliable. However neither responsibility is assumed for the consequences of its use nor for any infringement of patents or other rights of third parties, which may result from its use.

Specifications are subject to change without notice.

All trademarks used are property of their respective owners.



## 8 Revision History

### 8.1 Firmware Revision

Version	Date	Author	Description
TMCL-IDE: 3.0 Firmware: 3.06	2019-APR-08	ED	Latest TMCL-IDE 3.0 Version Firmware Version 3.06 or higher

Table 8.1 Firmware revision

### 8.2 Document Revision

Version	Date	Author	Description
0.92	2014-DEC-04	SD <small>SD – Sonja Dwersteg</small>	Initial version
1.00	2019-APR-08	SK	Pictures updated to latest HW version. Minor bugs corrected
1.01	2021-JAN-12	LH	Updated Trinamic Logo. Minor fixes.

Table 8.2 Document revision

## 9 References

[TMC5130A-TA] TMC5130A-TA Datasheet (please refer to <http://www.trinamic.com>)