

SUMMARY

Wires

Low voltage 6



Image is for illustrative purpose only

Series 2P
Termination type Female solder
IP rating 66
AWG wire size 28.00 - 20.00
Cable Ø 3.20 - 9.20 mm
Status active

Download

[Request a quote](#)

[Catalog](#)

TECHNICAL DETAILS

Mechanics

Shell Style/Model CN*: Fixed receptacle, nut fixing, watertight (IP 66)
Keying 3 keys (alpha=0, gamma=60; Plug: male contacts; Receptacle: female contacts)
Housing Material PSU (Polysulfone), gray
Weight 5.48 g

Performance

Configuration 2P.M06 : 6 Low V.
Insulator L: PEEK for solder contacts
Rated Current 12 Amps

Specifications

Contact Type: Solder
Contact Dia.: 1.3 mm (0.051in)
Bucket Dia.: 1.1 mm (0.043in)
Test voltage (kV rms) Contact-contact: 1.35
Air clearance min.: 1.2 mm
Creepage distance min.: 1.2 mm

Others

LEMO products and services are provided "as is". LEMO makes no warranties or representations with regard to LEMO product & services or use of them, express, implied or statutory, including for accuracy, completeness, or security. The user is fully responsible for his products and applications using LEMO components.

Endurance (Shell): >1000 mating cycles
 F ret (min): 150 N
 F ret (max): 250 N
 Steam sterilization: 20 times

DRAWINGS

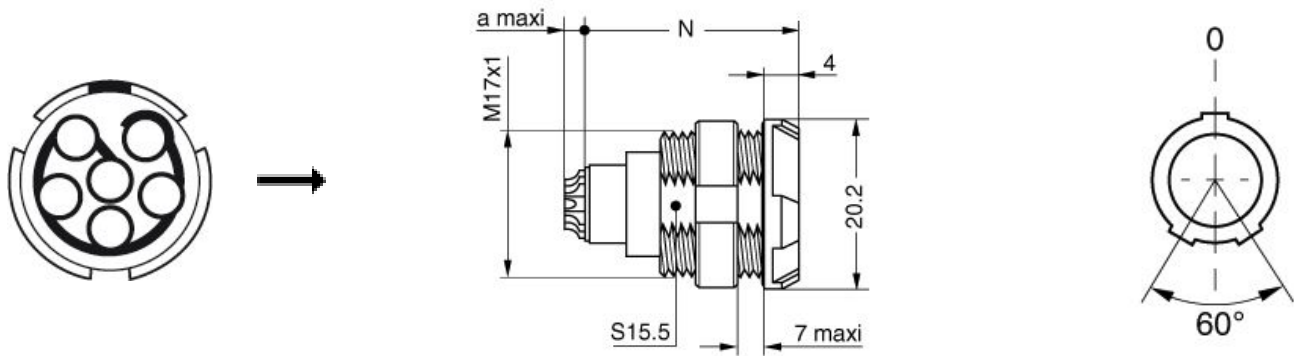

Dimensions

	A	L	N
mm.	20.2	28.7	23.8
in.	0,80	1,13	0,94













RECOMMENDED BY LEMO

Tools

Cables

CMN.06.T20.062PGZE		Grey	
CMN.06.T20.062PNZE			
CMN.06.T20.062QGZE	TPR (medical)	Grey	
CMN.06.T26.037QGZE	TPR (medical)	Grey	

LEMO products and services are provided "as is". LEMO makes no warranties or representations with regard to LEMO product & services or use of them, express, implied or statutory, including for accuracy, completeness, or security. The user is fully responsible for his products and applications using LEMO components.

CMN.06.T28.042QBCE	TPR (medical)		
CMN.06.T28.044PGZE		Grey	
CMN.06.T28.044PNZE			
106220	PVC	Black	
106240	PTFE	White	
12080	PVC	Grey	
160140	PVC	Grey	
160240	PVC	Black	
160260	PVC	Black	
260250	PVC	Grey	
360500	PVC	Grey	
360750	PVC	Grey	
60260	PTFE	White	
6280	PVC	Black	

LEMO products and services are provided "as is". LEMO makes no warranties or representations with regard to LEMO product & services or use of them, express, implied or statutory, including for accuracy, completeness, or security. The user is fully responsible for his products and applications using LEMO components.