

Housing - HC-EVO-B16-SHWS-2SSM25-PLRBK - 1421381

Please be informed that the data shown in this PDF Document is generated from our Online Catalog. Please find the complete data in the user's documentation. Our General Terms of Use for Downloads are valid (<http://phoenixcontact.com/download>)



Box mounting bases B16, with single locking latch, material: PA, cable outlets: 2, lateral, height: 84 mm, cable gland: none, support sleeve: no, 2x M25, Standard, including 2x reducing adapter

Your advantages

- ✓ Lower costs than metal version
- ✓ Low weight
- ✓ Lower risk of condensation
- ✓ Both contact insert PE sheets are connected by means of a metal frame integrated in the sleeve housing
- ✓ Metal inlays ensure leading PE contact with angled plugs
- ✓ Completely corrosion-resistant
- ✓ Halogen-free plastic
- ✓ Marking label can be attached



Key Commercial Data

Packing unit	1 pc
GTIN	 4 055626 264981
GTIN	4055626264981

Technical data

Dimensions

Height	84 mm
Width	57 mm
Length	117 mm

Ambient conditions

Degree of protection (IP)	IP66
Degree of protection (NEMA)	12 (UL 50e)
Ambient temperature (operation)	-40 °C ... 125 °C

General

Housing - HC-EVO-B16-SHWS-2SSM25-PLRBK - 1421381

Technical data

General

Note	For contact inserts HC-B16, BB32, D40, DD72, HS6, HV6, M, K, HV06-I-PR, HV 6-E...C
Size	B16
Housing type	Box mounting bases
Color	black
Locking type	with single locking latch
No. of cable outlets	2
Cable outlet	lateral
Screw connection	none
Type of the screw connection	2x M25
Housing material	PA
Seal material	NBR
Material lock	PA
Flammability rating according to UL 94	V0
Assembly instructions	Two plastic reductions M40 to M25 are provided
Connection	One of the two openings for the screw connections is sealed but can be broken open using a screwdriver.

Standards and Regulations

Flammability rating according to UL 94	V0
--	----

Environmental Product Compliance

China RoHS	Environmentally Friendly Use Period = 50
	For details about hazardous substances go to tab "Downloads", Category "Manufacturer's declaration"

Drawings

Housing - HC-EVO-B16-SHWS-2SSM25-PLRBK - 1421381

Dimensional drawing

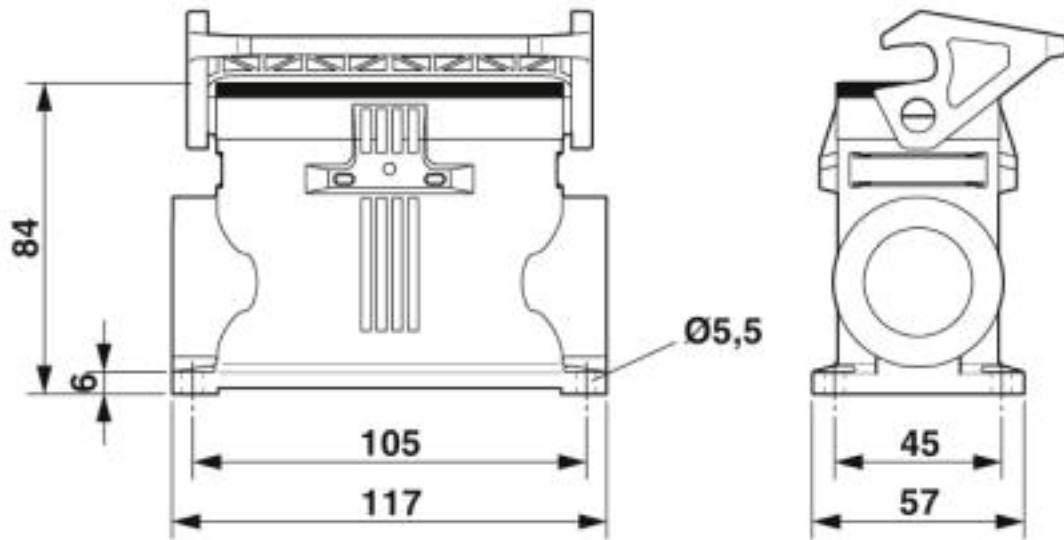

Dimensional drawing

Approvals

Approvals

Approvals

EAC / DNV GL

Ex Approvals

Approval details

EAC		RU C- DE.AI30.B.01102
-----	--	--------------------------

DNV GL		https://approvalfinder.dnvgl.com/	TAE000037S
--------	--	---	------------

Phoenix Contact 2019 © - all rights reserved
<http://www.phoenixcontact.com>

PHOENIX CONTACT GmbH & Co. KG
Flachsmarktstr. 8
32825 Blomberg
Germany
Tel. +49 5235 300
Fax +49 5235 3 41200
<http://www.phoenixcontact.com>