

Features

- Low Equivalent on Resistance
- Extremely Low Leakage (Typically 6 μ A @30V)
- High Current Capability ($I_F = 1.16A$)
- Low V_F , Fast Switching Schottky
- SOT23 Package
- ZLLS1000 Complements Low Temperature Equivalent ZHCS1000
- Package Thermally Rated to +150°C
- **Totally Lead-Free & Fully RoHS Compliant (Notes 1 & 2)**
- **Halogen and Antimony Free. "Green" Device (Note 3)**
- **Qualified to AEC-Q101 Standards for High Reliability**
- **An Automotive-Compliant Part is Available Under Separate Datasheet ([ZLLS1000QTA](#))**

Mechanical Data

- Case: SOT23
- UL Flammability Rating 94V-0
- Moisture Sensitivity: Level 1 per J-STD-020
- Terminals: Matte Tin Finish Annealed over Alloy 42 Leadframe. Solderable per MIL-STD-202, Method 208 **e3**
- Weight: 0.008 grams (Approximate)

Applications

- DC-DC Converters
- Strobes
- Mobile Phones
- Charging Circuits
- Motor Control

SOT23

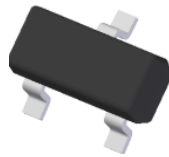

Top View

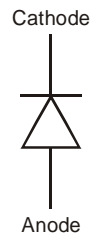

Device Symbol

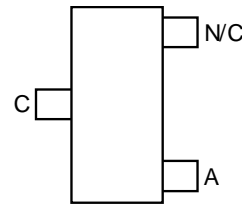

Pinout – Top View

Ordering Information (Note 4)

Part Number	Marking	Reel Size (inches)	Tape Width (mm)	Quantity Per Reel
ZLLS1000TA	L10	7	8	3,000 Units

- Notes:
1. No purposely added lead. Fully EU Directive 2002/95/EC (RoHS), 2011/65/EU (RoHS 2) & 2015/863/EU (RoHS 3) compliant.
 2. See <https://www.diodes.com/quality/lead-free/> for more information about Diodes Incorporated's definitions of Halogen- and Antimony-free, "Green" and Lead-free.
 3. Halogen- and Antimony-free "Green" products are defined as those which contain <900ppm bromine, <900ppm chlorine (<1500ppm total Br + Cl) and <1000ppm antimony compounds.
 4. For packaging details, go to our website at <https://www.diodes.com/design/support/packaging/diodes-packaging/>.

Marking Information

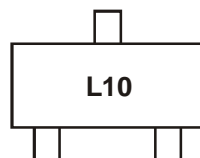

L10 = Product Type Marking Code

Maximum Ratings (@T_A = +25°C, unless otherwise specified.)

Characteristic	Symbol	Value	Unit
Continuous Reverse Voltage	V _R	40	V
Forward Current	I _F	1.16	A
Peak Repetitive Forward Current Rectangular Pulse Duty Cycle 50% 100µs Pulse Width	I _{FPK}	2.6	A
Non Repetitive Forward Current	I _{FSM}	22	A
		6.4	A

Thermal Characteristics

Characteristic	Symbol	Value	Unit
Power Dissipation @T _A = +25°C	P _D	0.8	W
Single Die Continuous		1.18	
Single Die Measured at t < 5s			
Thermal Resistance Junction to Ambient (Note 5)	R _{θJA}	155	°C/W
Thermal Resistance Junction to Ambient (Note 6)	R _{θJA}	106	°C/W
Thermal Resistance Junction to Lead (Solder Point)	R _{θJL}	80	°C/W
Storage Temperature Range	T _{STG}	-55 to +150	°C
Junction Temperature	T _J	+150	°C

Notes: 5. For a device surface mounted on 25mm x 25mm FR-4 PCB with high coverage of single sided 1oz copper, in still air conditions.
6. For a device mounted on FRB PCB measured at t < 5s.

Thermal Characteristics and Derating information

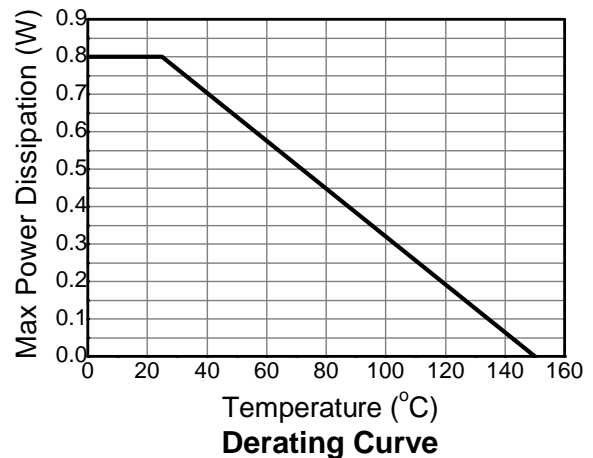
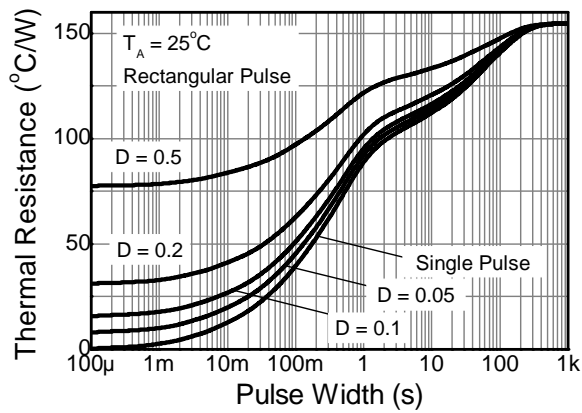

Electrical Characteristics (@ $T_A = +25^\circ\text{C}$, unless otherwise specified.)

Characteristic	Symbol	Min	Typ	Max	Unit	Test Condition
Reverse Breakdown Voltage	$V_{(BR)R}$	40	—	—	V	$I_R = 500\mu\text{A}$
Forward Voltage (Note 7)	V_F	—	320	355	mV	$I_F = 50\text{mA}$
			335	380		$I_F = 100\text{mA}$
			380	425		$I_F = 250\text{mA}$
			410	460		$I_F = 500\text{mA}$
			440	510		$I_F = 750\text{mA}$
			470	560		$I_F = 1\text{A}$
			530	660		$I_F = 1.5\text{A}$
			430	—		$I_F = 1000\text{mA}, T_A = +100^\circ\text{C}$
Reverse Current	I_R	—	5 500	20 —	μA μA	$V_R = 30\text{V}$ $V_R = 30\text{V}, T_A = +85^\circ\text{C}$
Diode Capacitance	C_D	—	28	—	pF	$f = 1\text{MHz}, V_R = 30\text{V}$
Reverse Recovery Time	t_{RR}	—	5	—	ns	Switched from $I_F = 500\text{mA}$ to $V_R = 5.5\text{V}$
Reverse Recovery Charge	Q_{RR}	—	350	—	nC	Measured @ $I_R 50\text{mA}, di/dt = 500\text{mA/ns}$ $R_{SOURCE} = 6\Omega; R_{LOAD} = 10\Omega$

Note: 7. Measured under pulsed conditions. Pulse width = 300 μs . Duty cycle < 2%.

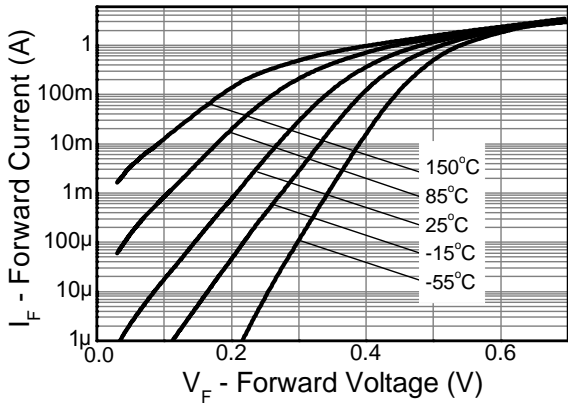

Typical Forward Characteristics

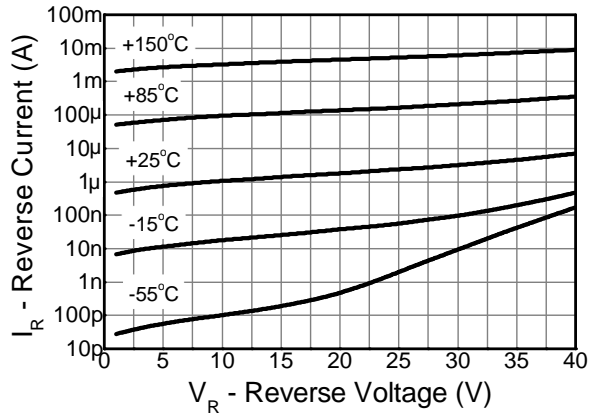

Typical Reverse Characteristics

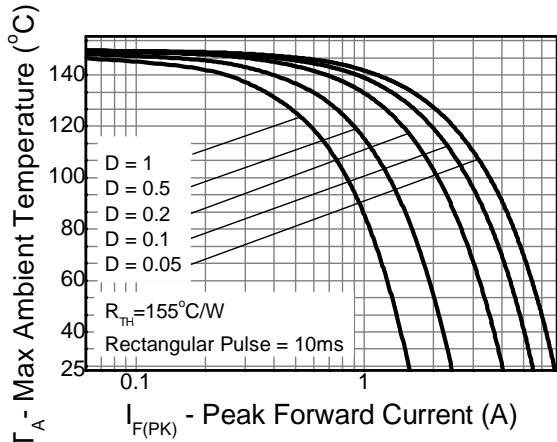

Typical Forward Safe Operating Area

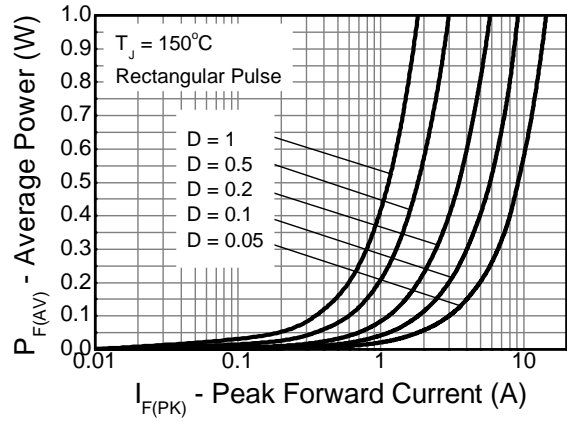

Forward Power vs Peak Current

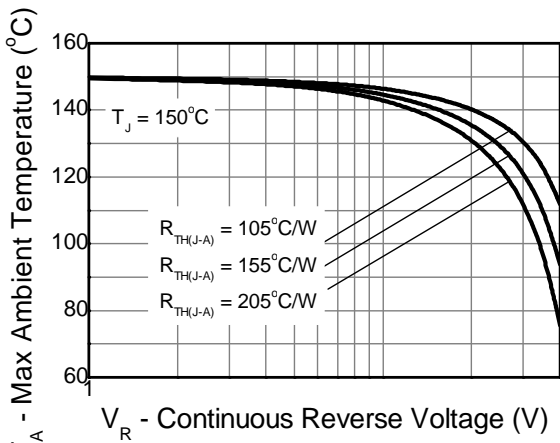

Typical Reverse Safe Operating Area

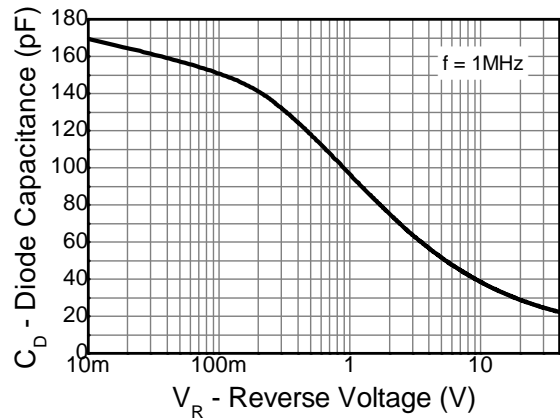

Capacitance vs Reverse Voltage

Package Outline Dimensions

Please see <http://www.diodes.com/package-outlines.html> for the latest version.

SOT23

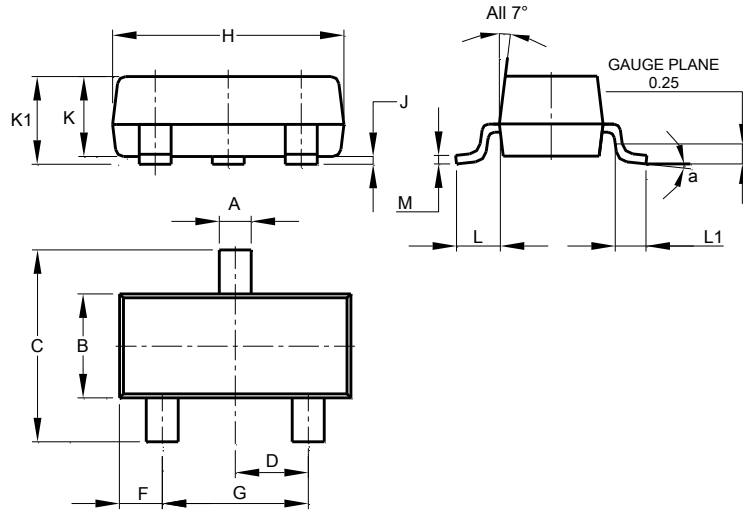

SOT23			
Dim	Min	Max	Typ
A	0.37	0.51	0.40
B	1.20	1.40	1.30
C	2.30	2.50	2.40
D	0.89	1.03	0.915
F	0.45	0.60	0.535
G	1.78	2.05	1.83
H	2.80	3.00	2.90
J	0.013	0.10	0.05
K	0.890	1.00	0.975
K1	0.903	1.10	1.025
L	0.45	0.61	0.55
L1	0.25	0.55	0.40
M	0.085	0.150	0.110
a	0°	8°	--
All Dimensions in mm			

Suggested Pad Layout

Please see <http://www.diodes.com/package-outlines.html> for the latest version.

SOT23

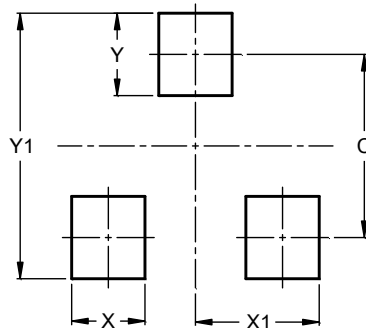

Dimensions	Value (in mm)
C	2.0
X	0.8
X1	1.35
Y	0.9
Y1	2.9

IMPORTANT NOTICE

DIODES INCORPORATED MAKES NO WARRANTY OF ANY KIND, EXPRESS OR IMPLIED, WITH REGARDS TO THIS DOCUMENT, INCLUDING, BUT NOT LIMITED TO, THE IMPLIED WARRANTIES OF MERCHANTABILITY AND FITNESS FOR A PARTICULAR PURPOSE (AND THEIR EQUIVALENTS UNDER THE LAWS OF ANY JURISDICTION).

Diodes Incorporated and its subsidiaries reserve the right to make modifications, enhancements, improvements, corrections or other changes without further notice to this document and any product described herein. Diodes Incorporated does not assume any liability arising out of the application or use of this document or any product described herein; neither does Diodes Incorporated convey any license under its patent or trademark rights, nor the rights of others. Any Customer or user of this document or products described herein in such applications shall assume all risks of such use and will agree to hold Diodes Incorporated and all the companies whose products are represented on Diodes Incorporated website, harmless against all damages.

Diodes Incorporated does not warrant or accept any liability whatsoever in respect of any products purchased through unauthorized sales channel. Should Customers purchase or use Diodes Incorporated products for any unintended or unauthorized application, Customers shall indemnify and hold Diodes Incorporated and its representatives harmless against all claims, damages, expenses, and attorney fees arising out of, directly or indirectly, any claim of personal injury or death associated with such unintended or unauthorized application.

Products described herein may be covered by one or more United States, international or foreign patents pending. Product names and markings noted herein may also be covered by one or more United States, international or foreign trademarks.

This document is written in English but may be translated into multiple languages for reference. Only the English version of this document is the final and determinative format released by Diodes Incorporated.

LIFE SUPPORT

Diodes Incorporated products are specifically not authorized for use as critical components in life support devices or systems without the express written approval of the Chief Executive Officer of Diodes Incorporated. As used herein:

A. Life support devices or systems are devices or systems which:

1. are intended to implant into the body, or
2. support or sustain life and whose failure to perform when properly used in accordance with instructions for use provided in the labeling can be reasonably expected to result in significant injury to the user.

B. A critical component is any component in a life support device or system whose failure to perform can be reasonably expected to cause the failure of the life support device or to affect its safety or effectiveness.

Customers represent that they have all necessary expertise in the safety and regulatory ramifications of their life support devices or systems, and acknowledge and agree that they are solely responsible for all legal, regulatory and safety-related requirements concerning their products and any use of Diodes Incorporated products in such safety-critical, life support devices or systems, notwithstanding any devices- or systems-related information or support that may be provided by Diodes Incorporated. Further, Customers must fully indemnify Diodes Incorporated and its representatives against any damages arising out of the use of Diodes Incorporated products in such safety-critical, life support devices or systems.

Copyright © 2019, Diodes Incorporated

www.diodes.com