

SERPAC RB53X06Y16Y 2

Electronic Enclosures

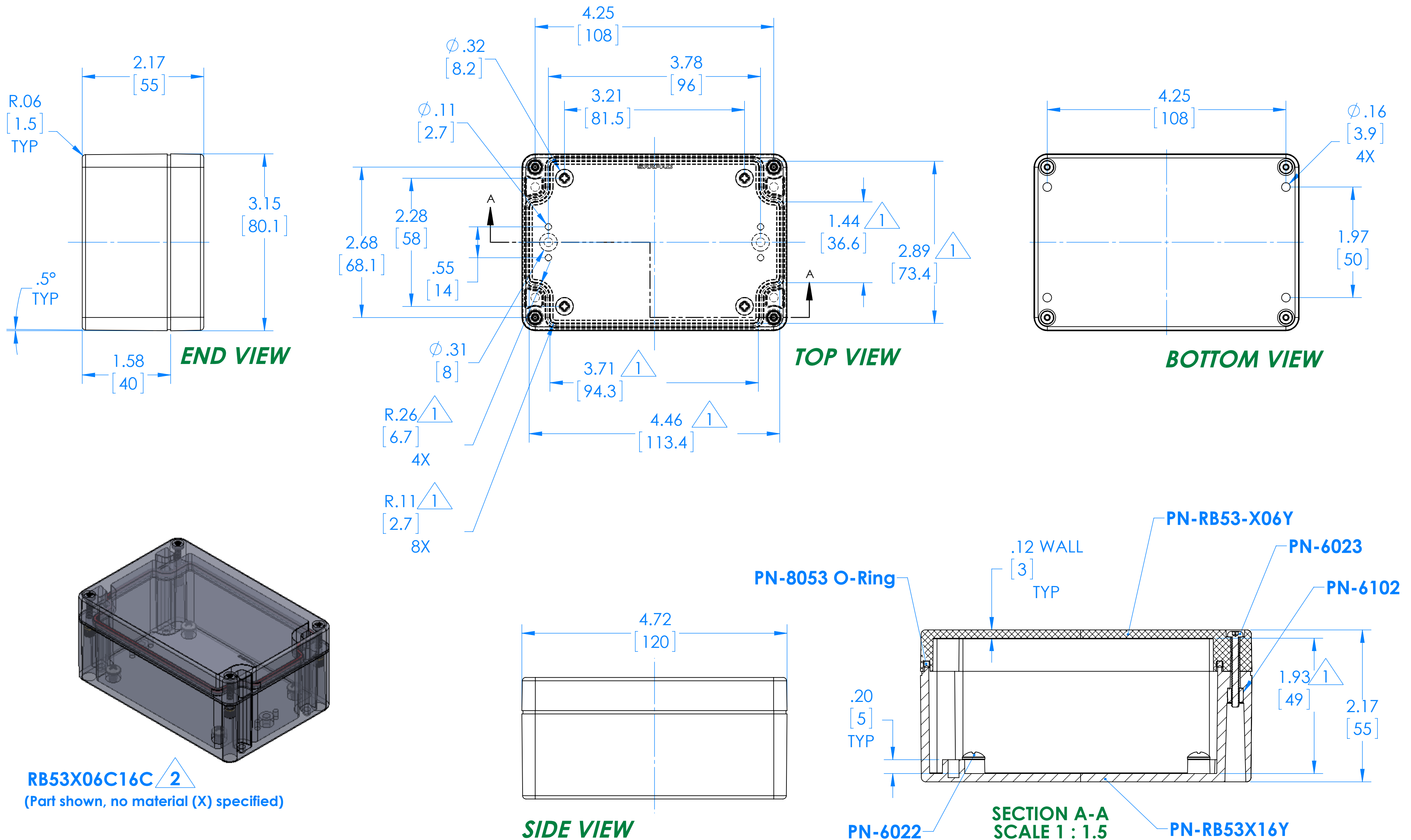

RB53X06C16C 2
 (Part shown, no material (X) specified)

PN	Description
RB53-X06Y	(1) RB53 06, Top
RB53X16Y	(1) RB53 16, Bottom
8053	(1) RB53 O-Ring
6023	(4) #4-40 Torx 10 Hd Screw
6022	(4) #10 High/Low Pan Hd x 1/4"
6102	(4) #4-40 Threaded Insert

1 =INTERIOR DIMENSIONS (@ BOTTOM)
2 =STANDARD COLORS (Y) ARE: BLACK (B), CLEAR (C) AND GRAY (G)
 TOPS AND BOTTOMS ALL POSSIBLE COMBINATIONS AVAILABLE
 STANDARD MATERIALS (X) ARE: POLYCARBONATE (P) AND ABS (A)

-Watertight enclosure meets or exceed Nema 4 and or IP67.

DIMENSIONS in Inch [mm]