

Product Description

The BSW7221 is a reflective SPDT RF switch that can be used in high power and good performance WLAN 802.11 a/b/g/n/ac/ax, DOCSIS 3.0/3.1 and Wireless Communication applications.

This device is packaged in RoHS2-compliant with 1.5mm x 1.5mm x 0.5mm, 6-Lead UDFN package. It must be used with back side ground soldering.

The BSW7221 has robust ESD protection circuits at all pins and temperature performance (operating temperature range : -40 to +105°C).

This switch does not require blocking capacitors. If DC is presented at the RF port, add a blocking capacitor. This device also has a high linearity performance over all temperature range such as IIP3, IIP2.

A functional block diagram is shown in Figure 1.

Block Diagram

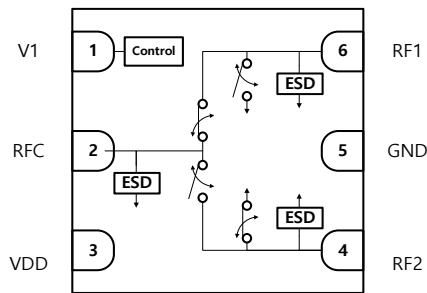

Figure 1 Functional Block Diagram

Applications

- WiMAX 802.16
- WLAN 802.11 a/b/g/n/ac/ax
- DOCSIS 3.0/3.1
- Drone
- NFC
- Bluetooth
- Smart Card
- Wireless Infrastructure
- Remote keyless entry
- Telematics / Infotainment
- Two-way radios
- Wireless control systems
- GPS/Navigation

Package Type



1.5mm x 1.5mm x 0.5mm, 6-Lead UDFN Package

Figure 2 Package Type

Device Features

- Output frequency range : 5 MHz to 8.0 GHz
- Fast Switching Time : 90 to 135 ns
- Supply Voltage : 2.7V to 3.6V
- Low insertion loss
 - : 0.38dB @ 2.45GHz
 - : 0.56dB @ 5.75GHz
- High isolation
 - : 44dB @ 2.45GHz
 - : 29dB @ 5.75GHz
- Input 1 dB output compression
 - : 37dBm @ 2.45GHz
 - : 35dBm @ 5.75GHz
- High IIP3
 - : 65dBm @ 2.45GHz
 - : 64dBm @ 5.75GHz
- ESD protection (HBM) : 2.0kV @ all pins
- 6-Lead UDFN package : 1.5mm x 1.5mm x 0.5mm
- Operating temperature range : -40°C to +105°C
- Lead-free/RoHS2-compliant UDFN package

Electrical Specifications

Typical conditions are at VDD = 3.3V, T_A = 25°C, V1 Low = 0V, V1 High = 3.3V, Z_L = 50Ω, Excluding SMA Connector and PCB loss⁽¹⁾, unless otherwise noted.

Table 1 Electrical Specifications

Parameter	Path	Condition	Min	Typ	Max	Unit
Operating Frequency			5		8000	MHz
Insertion Loss	RFC - RFx	13.56MHz		0.28		dB
		1GHz		0.32		
		2GHz		0.36		
		3GHz		0.40		
		4GHz		0.41		
		5GHz		0.42		
		6GHz		0.64		
		7GHz		0.46		
Isolation	RFC - RFx	13.56MHz		88		dB
		1GHz		52		
		2GHz		47		
		3GHz		40		
		4GHz		37		
		5GHz		35		
		6GHz		29		
		7GHz		28		
Isolation	RFx - RFx	13.56MHz		83		dB
		1GHz		45		
		2GHz		36		
		3GHz		33		
		4GHz		32		
		5GHz		30		
		6GHz		28		
		7GHz		24		
8GHz		21				
Return Loss	RFC, RF1, RF2	5MHz – 8GHz (Active port)		20		dB
Input P1dB	RFC - RFx	13.56MHz		33		dBm
		2.45GHz		37		
		5.75GHz		35		
Input IP ₃ ⁽²⁾	RFC - RFx	2.45GHz		65		dBm
		5.75GHz		64		
Input IP ₂ ⁽²⁾	RFC - RFx	2.45GHz		105		dBm
		5.75GHz		90		
2 nd Harmonic ⁽³⁾	RFC - RFx	2.45GHz		95		dBc
		5.75GHz		80		
3 rd Harmonic ⁽³⁾	RFC - RFx	2.45GHz		100		dBc
		5.75GHz		100		
Switching Time	RFC - RFx	50% control to 90% RF		135		ns
		50% control to 10% RF		90		
Settling Time	RFC - RFx	50% CTRL to 0.05dB final value Rising Edge		145		ns
		50% CTRL to 0.05dB final value Falling Edge		110		

The typical spurious performance of the BSW7221 is -115dBm / 10Hz @ Over 10MHz

(1) Excluding SMA Connector and PCB loss.

1GHz (0.14dB), 2GHz (0.22dB), 3GHz (0.27dB), 4GHz (0.36dB), 5GHz (0.41dB), 6GHz (0.45dB), 7GHz (0.59dB), 8GHz (0.64dB)

(2) The two-tone Power is 18dBm each and Tone spacing is 20KHz.

(3) Tone Power is 18dBm.

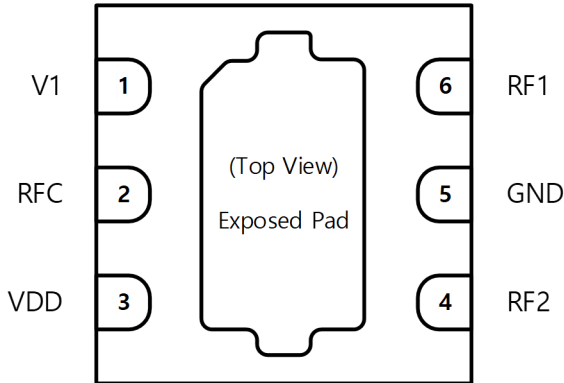
Product Description

Figure 3 Functional Block Diagram
Table 2 Pin Descriptions

No.	Pin Name	Descriptions
1	V1	Digital Control Logic Input
2	RFC	RF Common port
3	VDD	Supply Voltage
4	RF2	RF2 port
5	GND	Ground
6	RF1	RF1 port
Pad	Exposed Pad	Ground

Table 3 V1 Control Truth Table

V1	RFC-RF1	RFC-RF2
0	OFF	ON
1	ON	OFF

Table 4 Recommended Operation Conditions*

Parameter	Symbol	Min	Typ	Max	Unit
Supply Voltage	VDD	2.7	3.3	3.6	V
Supply Current	IDD	-	170	-	μA
Digital Input Control (V1)	V1 High	1.0	-	3.3	V
	V1 Low	0	-	0.7	V
Operating Temperature Range	To	-40	+25	+105	°C
RF Input Power, CW Freq.=2.45GHz, 5.75GHz any port, Zi=50Ω	-	-	-	30	dBm

*Specifications are not guaranteed over all recommended operating conditions.

Table 5 Absolute Maximum Ratings

Parameter	Symbol	Min	Max	Unit
Supply Voltage	VDD	-0.3	3.6	V
Digital Input Voltage (V1)	V1	-0.3	3.6	V
Maximum Input Power, CW (+25°C)	-	-	Input P1dB	dBm
Storage Temperature range	-	-65	+150	°C
ESD	HBM	All pins	2000	V
	CDM	All pins	1000	V

Typical Performances

Typical conditions are at VDD = 3.3V, T_A = 25°C, V1 Low = 0V, V1 High = 3.3V, Z_L = 50Ω, Excluding SMA Connector and PCB loss, unless otherwise noted.

Figure 4 Insertion Loss vs. Vdd (RFC - RFx)

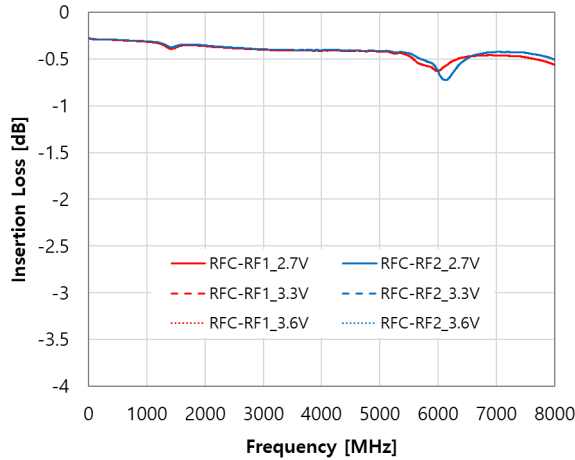

Figure 5 Insertion Loss vs. Temp (RFC - RFx)

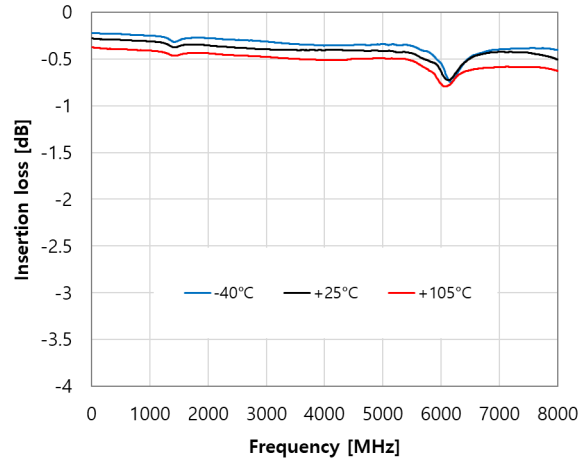

Figure 6 Return Loss (RFC, RFx)

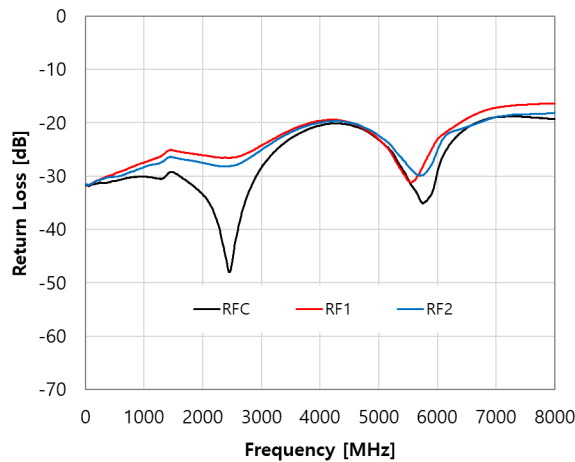
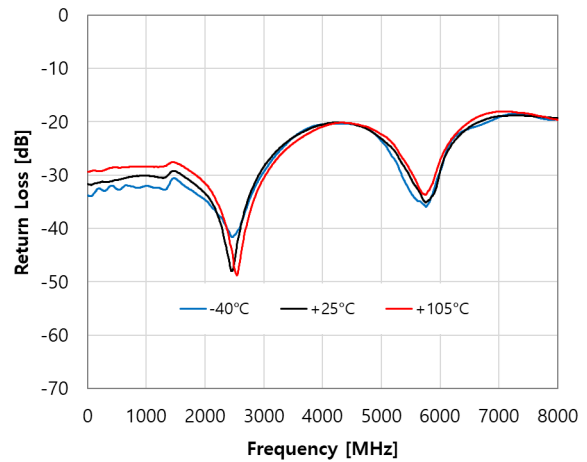

Figure 7 Return Loss vs. Temp (RFC)



Typical Performances

Typical conditions are at VDD = 3.3V, T_A = 25°C, V1 Low = 0V, V1 High = 3.3V, Z_L = 50Ω, Excluding SMA Connector and PCB loss, unless otherwise noted.

Figure 8 Isolation vs. Vdd (RFC - RFx)

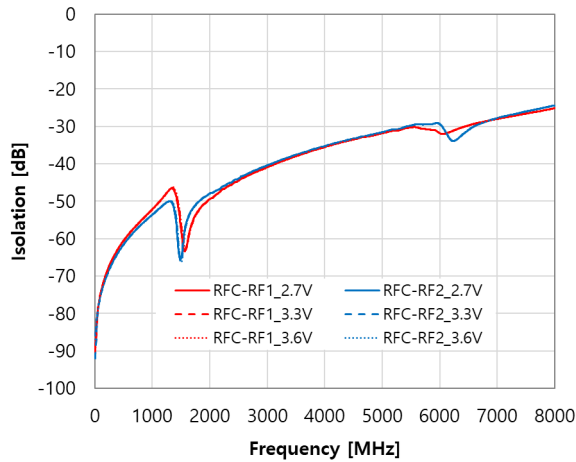

Figure 9 Isolation vs. Temp (RFC - RFx)

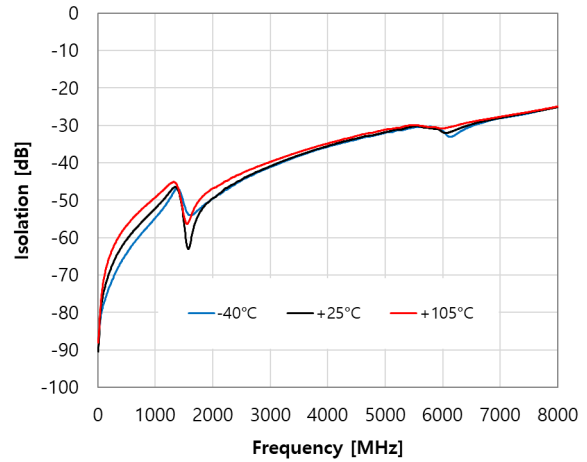

Figure 10 Isolation vs. Vdd (RFx - RFx)

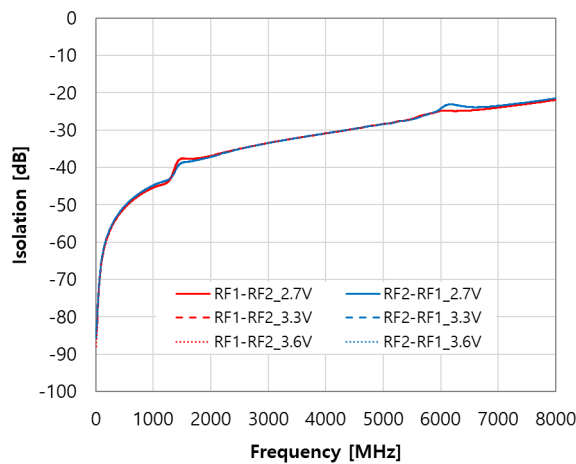
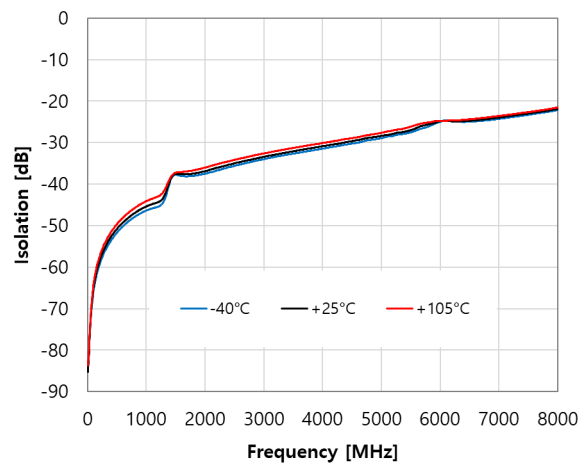

Figure 11 Isolation vs. Temp (RFx - RFx)



Evaluation Board

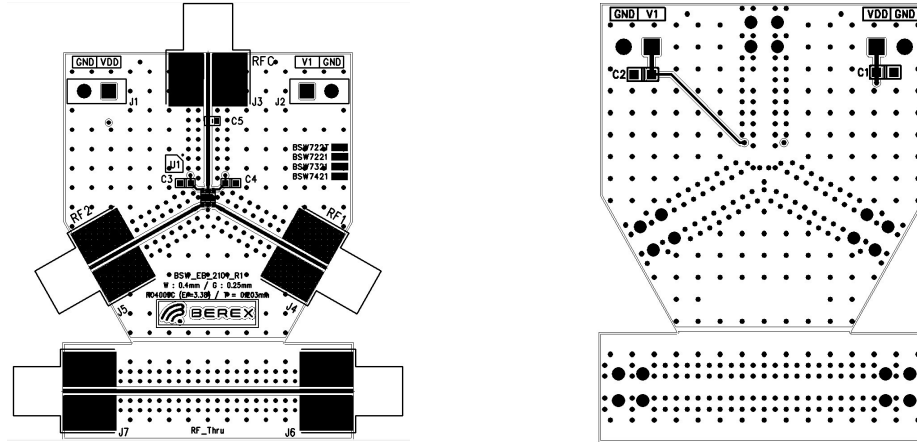

Figure 12 Evaluation Board Layout

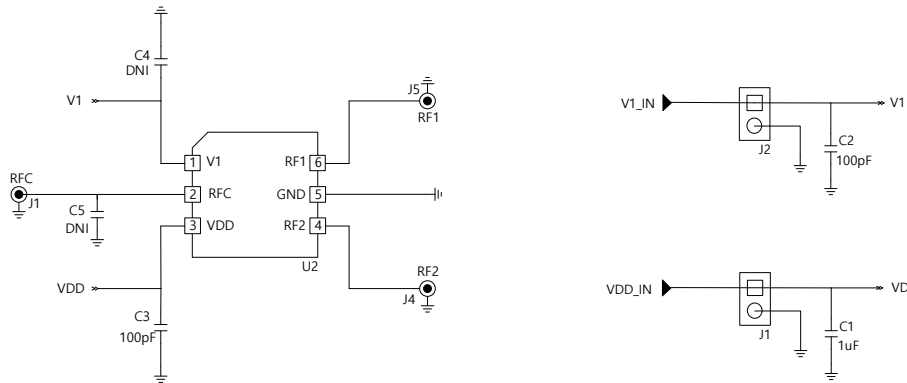

Figure 13 Evaluation Board Schematic

RO4003C Er : 3.38	COPPER : 1oz (0.035mm), Top Layer	<p>FINISH THICKNESS : 1.63T</p>
FR-4 Er : 4.5~4.8	RO4003C / 0.2mm	
	COPPER : 1oz (0.035mm), Inner 1 Layer	
FR-4 Er : 4.5~4.8	FR-4 / 0.36mm	
	COPPER : 1oz (0.035mm), Inner 2 Layer	
	FR-4 / 0.93mm	
	COPPER : 1oz (0.035mm), Bottom Layer	

Figure 14 Evaluation Board PCB Layer Information

No.	Ref Des	Part Qty	Part Number	Remark
1	C1	1	CAP 1005 1uF J 50V	
2	C2,C3*	2	CAP 1005 100pF J 50V	
3	C4	2	CAP 1005 DNI	
4	C5	1	CAP 0603 DNI	
6	J1,J2	2	2 Pin Header	
7	RFC, RF1, RF2	3	SMA_END_LAUNCH	
8	U1	1	BSW7221	

* C3 should be placed near the device.

Table 6 Bill of Material - Evaluation Board

Package Outline Drawing

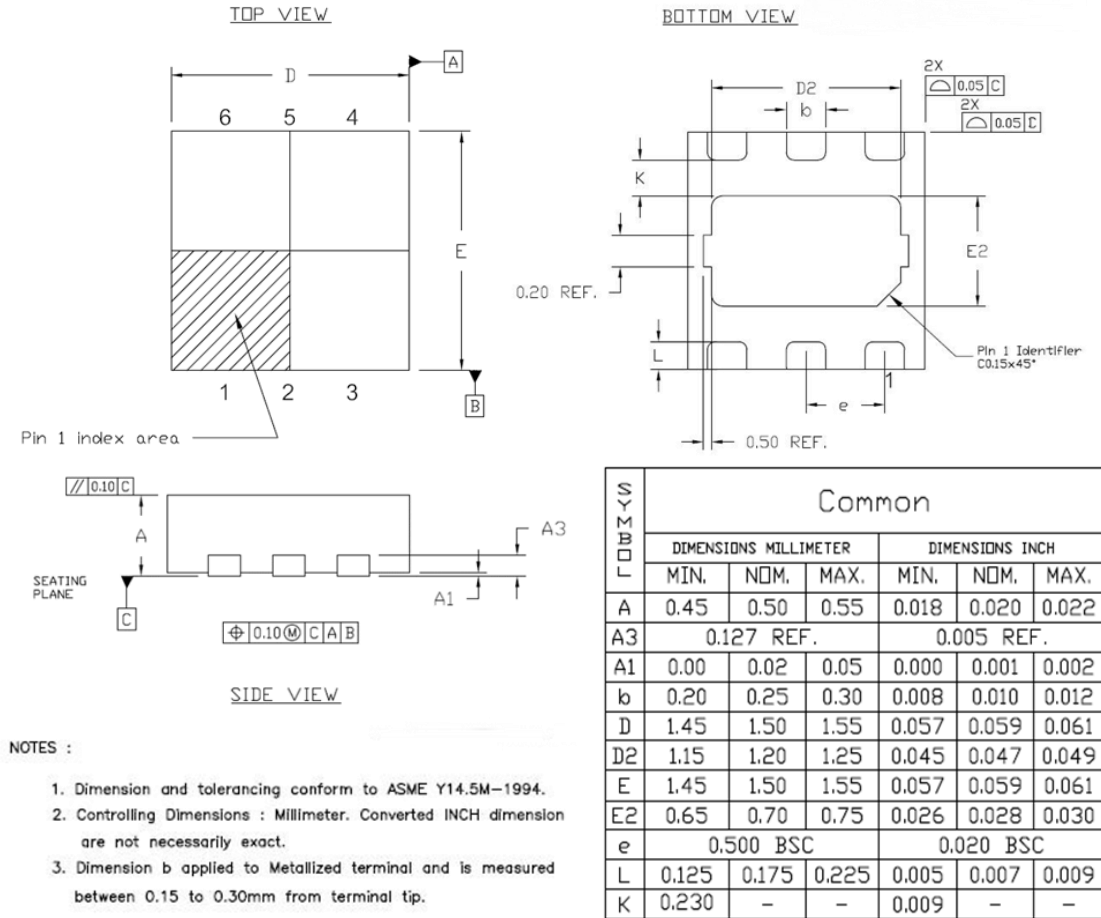

Figure 15 Package Outline Drawing

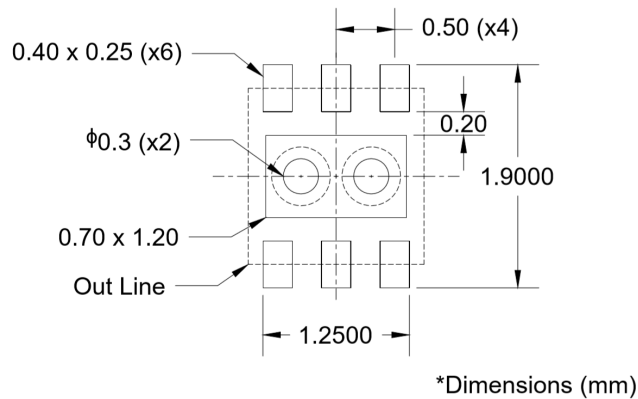
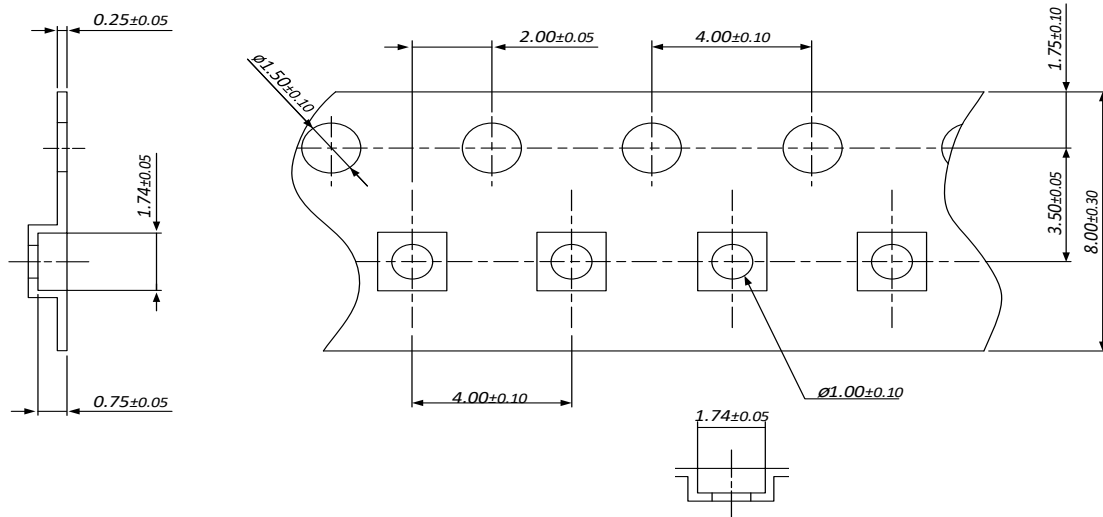
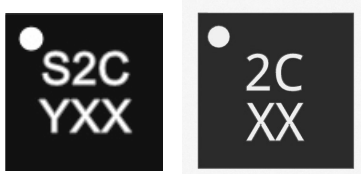

Figure 16 Recommended Land Pattern

Tape & Reel

Packaging information:	
Tape Width	8mm
Reel Size	7inch
Device Cavity Pitch	4mm
Device Per Reel	3000EA

Figure 17 Tape & Reel
Package Marking

Marking information:			
Marking Code 1		Marking Code 2	
S	RF Switch	2	The number of switch throw
2	The number of switch throw	C	Sequential Number
C	Sequential Number	XX	Wafer Lot Number
Y	Work Year		
XX	Wafer Lot Number		

Figure 18 Package Marking

Lead plating finish

100% Tin Matte finish

(All BeRex products undergoes a 1 hour, 150 degree C, Anneal bake to eliminate thin whisker growth concerns.)

MSL / ESD Rating

ESD information:	
Rating	Class 2 (2000V)
Test	Human Body Model (HBM)
Standard	JS-001-2017

MSL information:	
Rating	Level 1 at +260°C convection reflow
Standard	JEDEC Standard J-STD-020



Proper ESD procedures should be followed when handling the device.

RoHS Compliance

This part is compliant with Restrictions on the use of certain Hazardous Substances in Electrical and Electronic Equipment (RoHS) Directive 2011/65/EU as amended by Directive 2015/863/EU.

This product also is compliant with a concentration of the Substances of Very High Concern (SVHC) candidate list which are contained in a quantity of less than 0.1%(w/w) in each components of a product and/or its packaging placed on the European Community market by the BeRex and Suppliers.

NATO CAGE code:

2	N	9	6	F
---	---	---	---	---