

REVISIONS

P	LTR	DESCRIPTION	DATE	DWN	APVD
DI		REVISED (ECR-23-171026)	31MAR2023	CI	KT

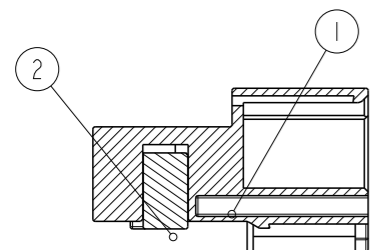

SECTION A - A

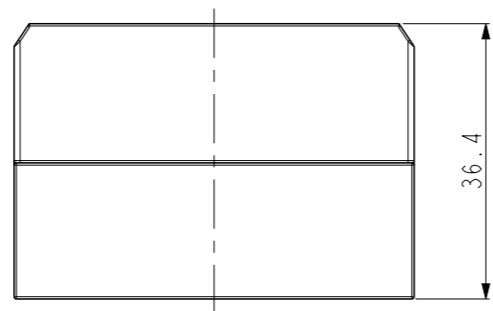
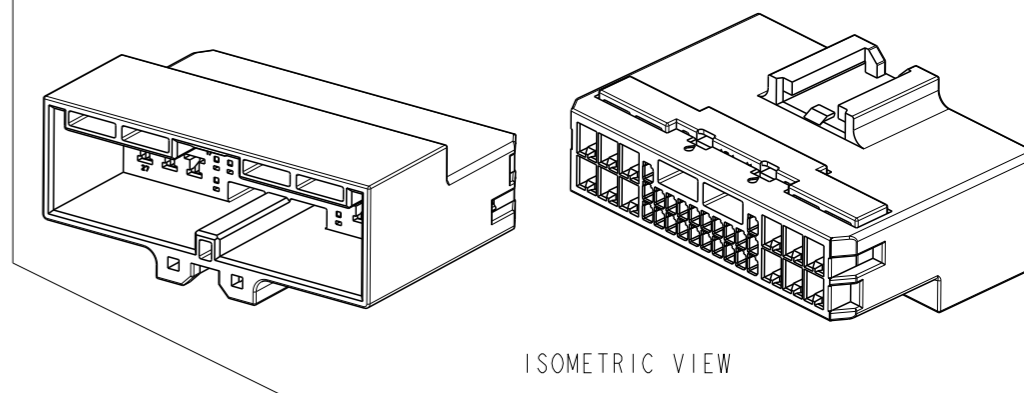
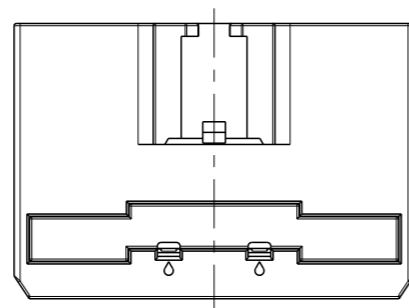
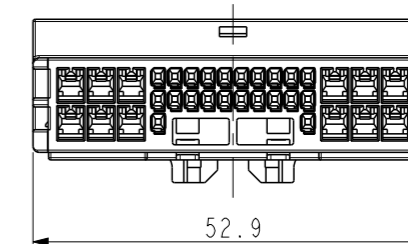
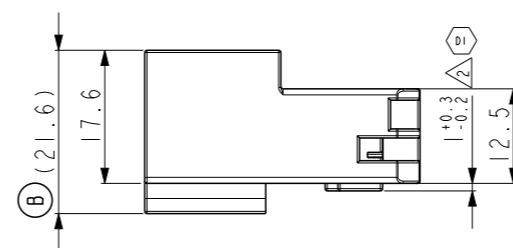
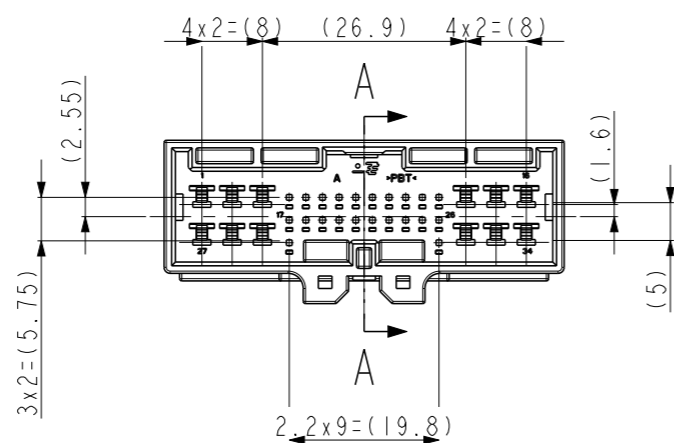

<TABLE 1>

TYPE	FINISH	P/N	WIRE RANGE (mm ²)
.025	PRE-TIN	2005098-1	0.22
	GOLD	2005154-1	0.37~0.56
.090	PRE-TIN	1897752-1	0.22~0.56
		368088-1	0.3~0.5
		368087-1	0.85~1.25
	GOLD	1-368088-1	2.0~2.5

NOTE
 1. GENERAL TOLERANCE: ±0.3, ±3°
 2. CONDITION OF DELIVERY
 DBL IN 1st LOCKING POSITION
 3. APPLICABLE PLUG ASS'Y P/N: x-2005431-x
 4. APPLICABLE TAB CONTACT P/N: <TABLE 1>

NO	FINISH/COLOR	MATERIAL	DESCRIPTION	Q'TY
2	WHITE	PBT	CAP DBL HSG	1
1	RED	PBT	CAP HSG	1
	BROWN	PBT	CAP HSG	1
	WHITE	PBT	CAP HSG	1

ASS'Y P/N	DESCRIPTION
2005434-6	HYB 34P CAP ASS'Y
2005434-4	HYB 34P CAP ASS'Y
2005434-1	HYB 34P CAP ASS'Y

THIS DRAWING IS A CONTROLLED DOCUMENT.

DIMENSIONS: mm

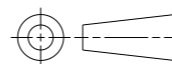

TOLERANCES UNLESS OTHERWISE SPECIFIED:

0 PLC	±
1 PLC	±
2 PLC	±
3 PLC	±
4 PLC	±
ANGLES	±
FINISH	±

MATERIAL SEE TABLE

DWN
CH PARK
CHK
JW JUNG
APVD
HG CHO
PRODUCT SPEC

APPLICATION SPEC

WEIGHT

CUSTOMER DRAWING



NAME 025/090 HYBRID 34P CAP ASS'Y

SIZE A3 CAGE CODE 00779 DRAWING NO C-2005434 RESTRICTED TO

SCALE 1:1 SHEET 1 OF 1 REV DI