



ULTRA LOW NOISE, LOW CURRENT

E-PHEMT Transistor

TAV-551+

50Ω 0.45-6GHz

THE BIG DEAL

- Low Noise Figure, 0.5 dB
- Gain, 16 dB at 2 GHz
- High Output IP3, +25 dBm
- Low Current, 15mA
- Wide bandwidth
- External biasing and matching required



Generic photo used for illustration purposes only

CASE STYLE: FG873

+RoHS Compliant

The +Suffix identifies RoHS Compliance. See our web site for RoHS Compliance methodologies and qualifications

APPLICATIONS

- Cellular
- ISM
- GSM
- WCDMA
- WiMax
- WLAN
- UNII and HIPERLAN

GENERAL DESCRIPTION

TAV-551+ is an ultra-low noise, high IP3 transistor device, manufactured using E-PHEMT* technology enabling it to work with a single positive supply voltage. It has outstanding Noise Figure, particularly below 2.5 GHz, and when combining this noise figure with high IP3 performance in a single device it makes it an ideal amplifier for demanding base station applications. We offer these units assembled into a complete module, 50Ω in/out, noise matched and fully specified. For more information please see our TAMP family of models on our web site.

SIMPLIFIED SCHEMATIC AND PAD DESCRIPTION

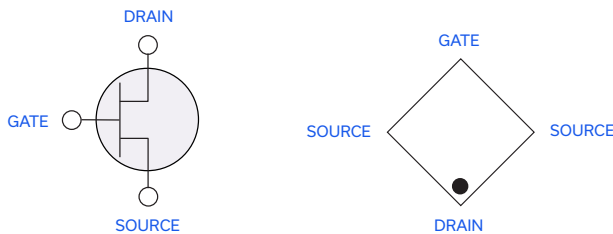

Function	Pad Number	Description
Source	2 & 4	Source terminal, normally connected to ground
Gate	3	Gate used for RF input
Drain	1	Drain used for RF output

* Enhancement mode Pseudomorphic High Electron Mobility Transistor.

REV. D
ECO-011337
TAV-551+
220106





ULTRA LOW NOISE, LOW CURRENT

E-PHEMT Transistor

TAV-551+

ELECTRICAL SPECIFICATIONS AT $T_{AMB}=25^{\circ}\text{C}$, FREQUENCY 0.45 TO 6 GHz

Symbol	Parameter	Condition	Min.	Typ.	Max.	Units	
DC Specifications							
V_{GS}	Operational Gate Voltage	$V_{DS}=3\text{V}, I_{DS}=15\text{ mA}$	0.22	0.34	0.46	V	
V_{TH}	Threshold Voltage	$V_{DS}=3\text{V}, I_{DS}=4\text{ mA}$	0.18	0.26	0.38	V	
I_{DSS}	Saturated Drain Current	$V_{DS}=3\text{V}, V_{GS}=0\text{ V}$		1.0	5.0	μA	
G_M	Transconductance	$V_{DS}=3\text{V}, G_m=\Delta I_{DS}/\Delta V_{GS}$ $\Delta V_{GS}=V_{GS1}-V_{GS2}$ $V_{GS1}=V_{GS}$ at $I_{DS}=15\text{ mA}$ $V_{GS2}=V_{GS1}+0.05\text{V}$	— — 215 — —	— — 251 — —	— — 285 — —	mS	
I_{GSS}	Gate leakage Current	$V_{GD}=V_{GS}=-3\text{V}$			95	μA	
RF Specifications, $Z_0=50\text{ Ohms}$ (Figure 1)							
$NF^{(1)}$	Noise Figure	$V_{DS}=3\text{V}, I_{DS}=15\text{ mA}$ $V_{DS}=4\text{V}, I_{DS}=15\text{ mA}$	f=0.9 GHz f=2.0 GHz f=3.9 GHz f=5.8 GHz	0.4 0.5 0.95 1.7	0.9	dB	
Gain	Gain	$V_{DS}=3\text{V}, I_{DS}=15\text{ mA}$ $V_{DS}=4\text{V}, I_{DS}=15\text{ mA}$	f=0.9 GHz f=2.0 GHz f=3.9 GHz f=5.8 GHz	— 15.0 — — —	21.3 16.3 11.3 8.4 16.3	— 17.3 — — —	dB
OIP3	Output IP3	$V_{DS}=3\text{V}, I_{DS}=15\text{ mA}$ $V_{DS}=4\text{V}, I_{DS}=15\text{ mA}$	f=0.9 GHz f=2.0 GHz f=3.9 GHz f=5.8 GHz	22.1 23.5 25.0 26.0		dBm	
$P_{1dB}^{(2)}$	Power output at 1 dB Compression	$V_{DS}=3\text{V}, I_{DS}=15\text{ mA}$ $V_{DS}=4\text{V}, I_{DS}=15\text{ mA}$	f=0.9 GHz f=2.0 GHz f=3.9 GHz f=5.8 GHz	17.0 17.5 18.7 19.2		dBm	

MAXIMUM RATINGS⁽³⁾

Symbol	Parameter	Max.	Units
$V_{DS}^{(4)}$	Drain-Source Voltage	5	V
$V_{GS}^{(4)}$	Gate-Source Voltage	-5 to 0.7	V
$V_{GD}^{(4)}$	Gate-Drain Voltage	-5 to 0.7	V
$I_{DS}^{(4)}$	Drain Current	100	mA
I_{GS}	Gate Current	2	mA
P_{DISS}	Total Dissipated Power	550	mW
$P_{IN}^{(5)}$	RF Input Power	17	dBm
T_{CH}	Channel Temperature	150	$^{\circ}\text{C}$
T_{OP}	Operating Temperature	-40 to 85	$^{\circ}\text{C}$
T_{STD}	Storage Temperature	-65 to 150	$^{\circ}\text{C}$
θ_{JC}	Thermal Resistance	112	$^{\circ}\text{C}/\text{W}$

(1) Includes test board loss (measured in Mini-Circuits test board TB-154).
 (2) Drain current was allowed to increase during compression measurements.
 (3) Operation of this device above any one of these parameters may cause permanent damage.
 (4) Assumes DC quiescent conditions.
 (5) IGS is limited to 2 mA during test.





CHARACTERIZATION TEST CIRCUIT

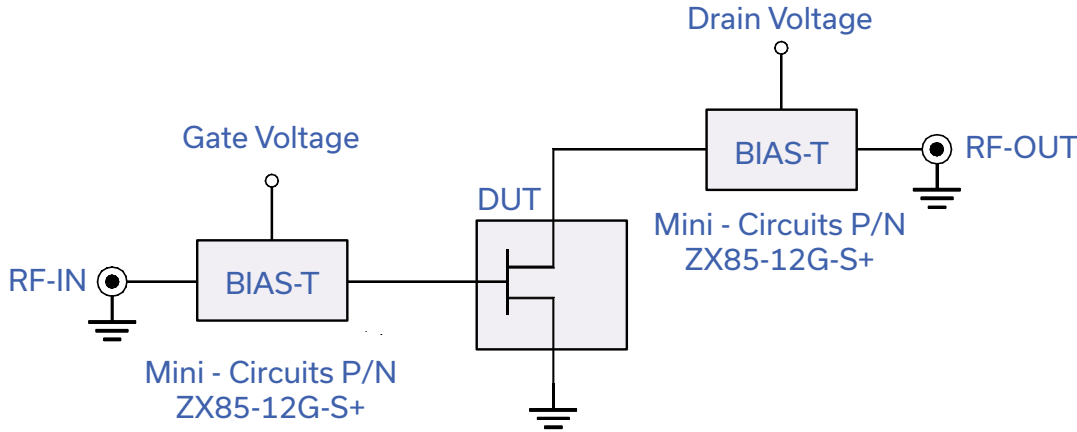

Fig 1. Block Diagram of Test Circuit used for characterization. (DUT soldered on Mini-Circuits Test Board TB-154)

Gain, Output power at 1dB compression (P1 dB) and output IP3 (OIP3) are measured using R&S Network Analyzer ZVA-24. Noise Figure measured using Agilent's Noise Figure meter N8975A and noise source N4000A.

Conditions:

1. Drain voltage (with reference to source, V_{DS})= 3 or 4V as shown.
2. Gate Voltage (with reference to source, V_{GS}) is set to obtain desired Drain-Source current (I_{DS}) as shown in graphs or specification table.
3. Gain: $P_{in} = -25\text{dBm}$
4. Output IP3 (OIP3): Two tones, spaced 1 MHz apart, 0 dBm/tone at output.
5. No external matching components used.

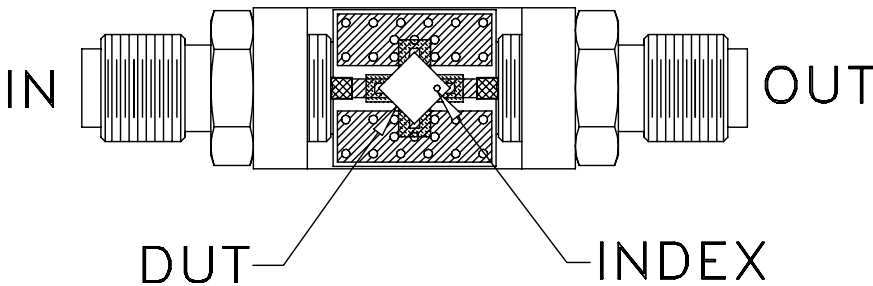
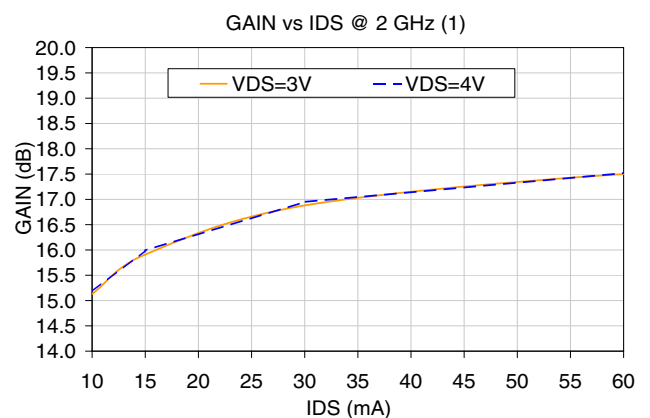
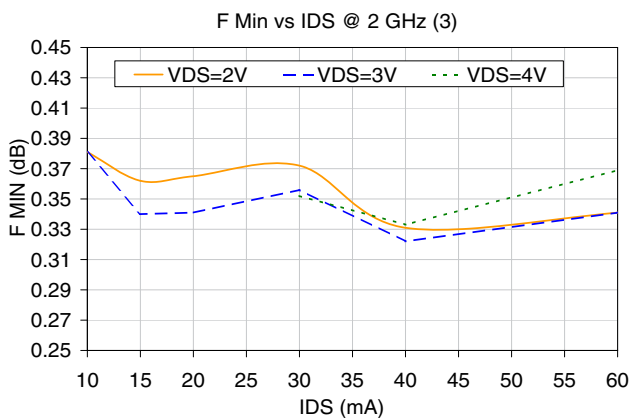
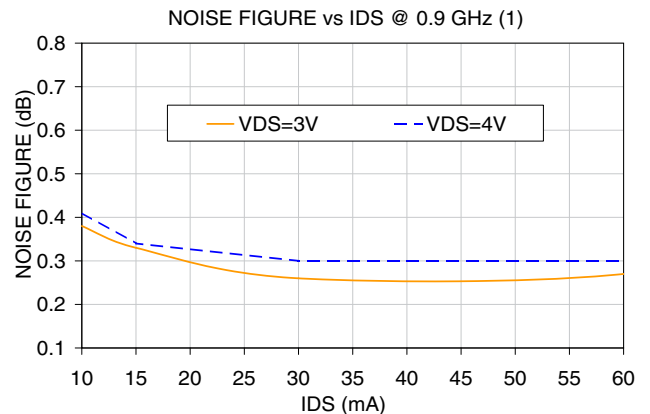
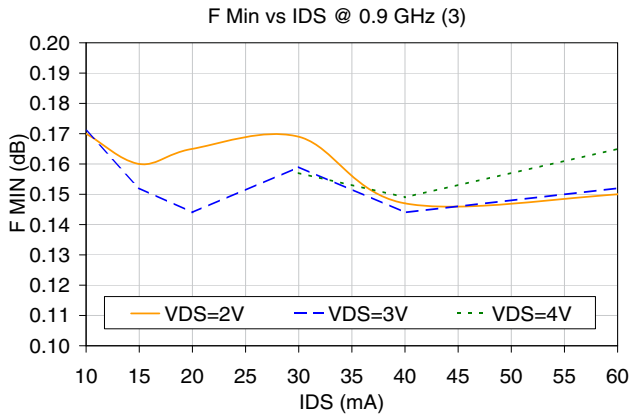
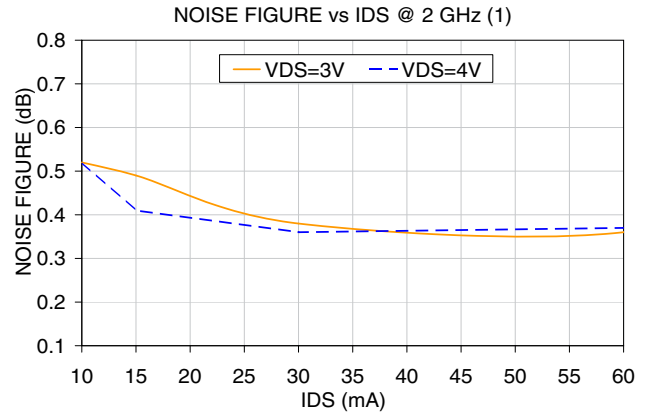
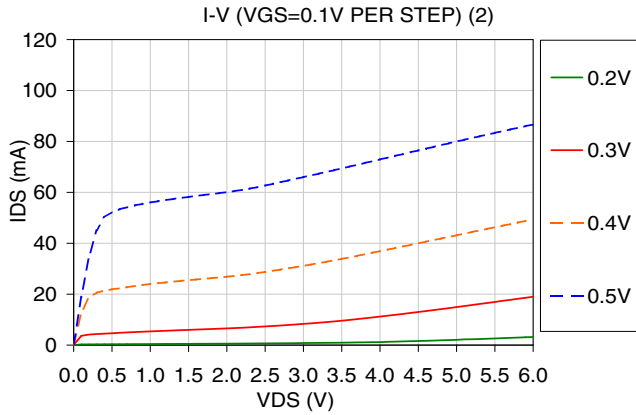

Fig 2. Test Board used for characterization, Mini-Circuits P/N TB-154 (Material: Rogers 4350, Thickness: 0.02")



TYPICAL PERFORMANCE CURVES



(1) Includes test board loss, set-up and conditions per Figure 1.
 (2) Measured using HP4155B semiconductor parameter analyzer.
 (3) F Min is minimum Noise Figure.
 (4) Drain current was allowed to increase during compression measurement.



TYPICAL PERFORMANCE CURVES

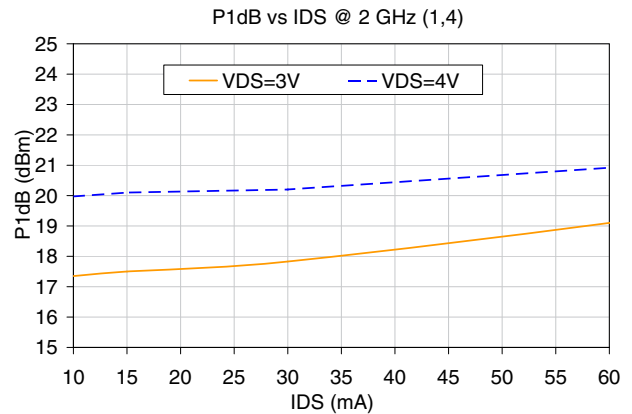
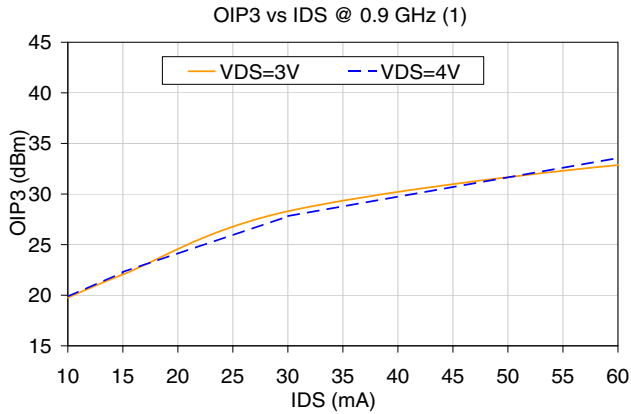
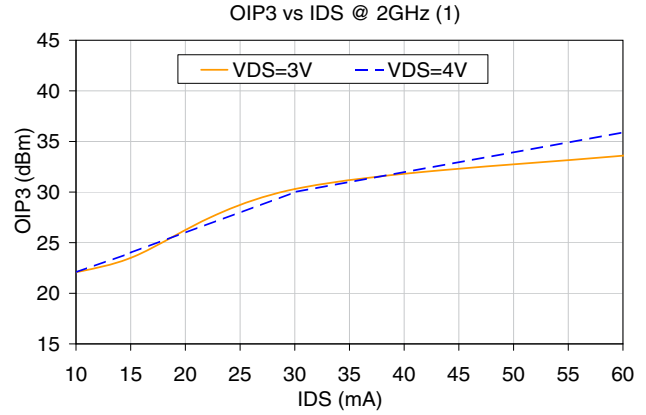
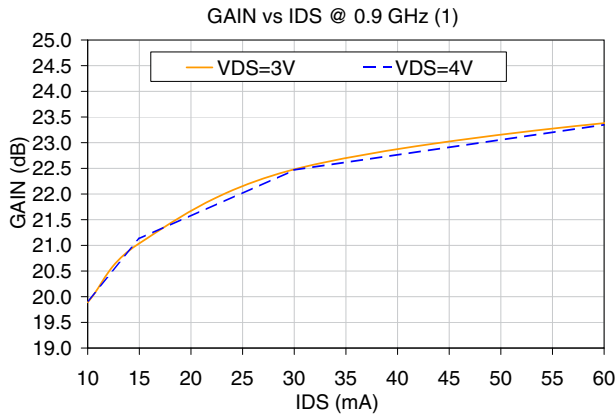

Data at -45°C is extrapolated

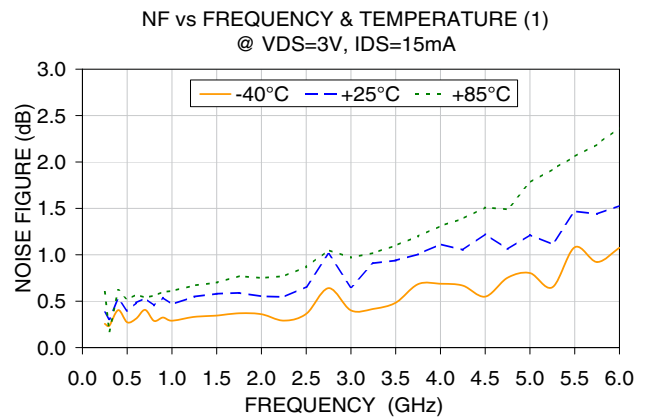
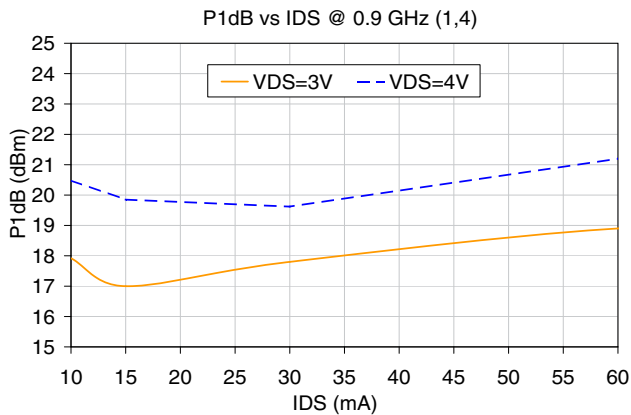

- (1) Includes test board loss, set-up and conditions per Figure 1.
- (2) Measured using HP4155B semiconductor parameter analyzer.
- (3) F Min is minimum Noise Figure.
- (4) Drain current was allowed to increase during compression measurement.



TYPICAL PERFORMANCE CURVES

GAIN vs FREQUENCY & TEMPERATURE (1)
@ VDS=3V, IDS=15mA

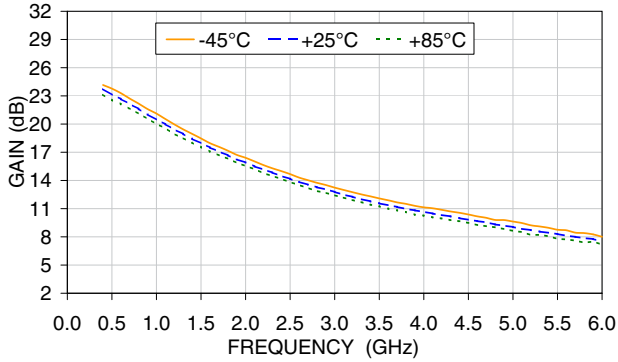

OIP3 vs FREQUENCY & TEMPERATURE (1)
@ VDS=3V, IDS=15mA

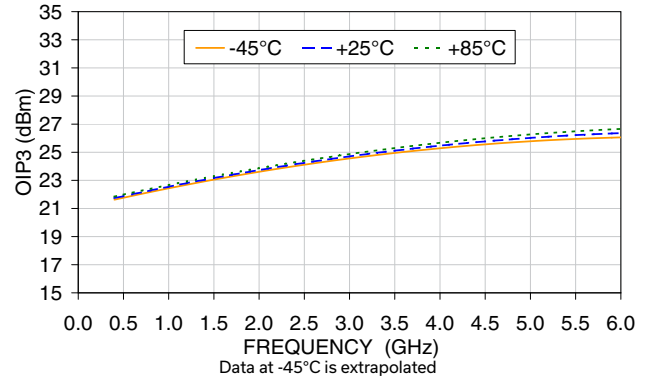

P1dB vs FREQUENCY & TEMPERATURE (1,4)
@ VDS=3V, IDS=15mA

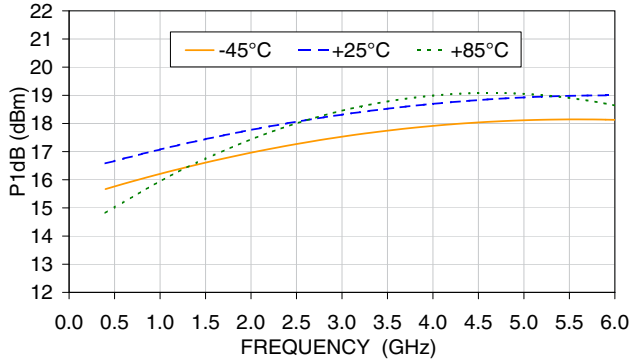

NF vs FREQUENCY & TEMPERATURE (1)
@ VDS=4V, IDS=15mA

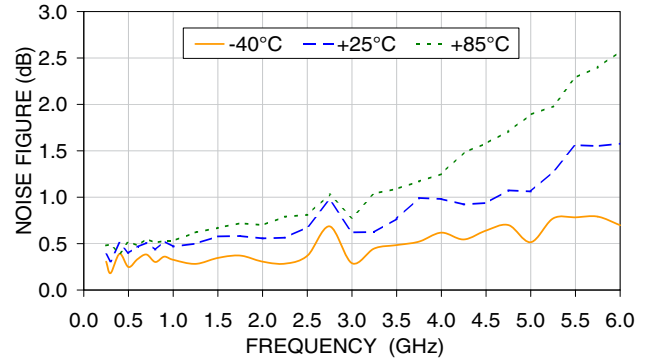

GAIN vs FREQUENCY & TEMPERATURE (1)
@ VDS=4V, IDS=15mA

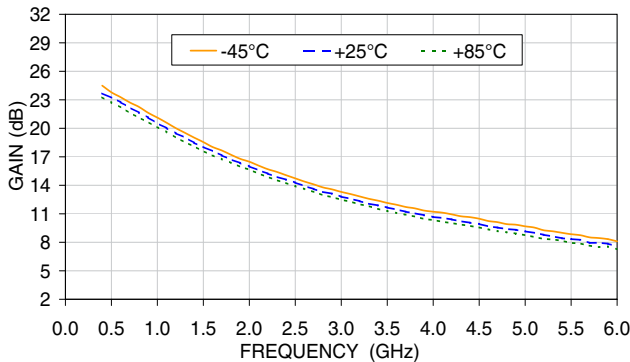

OIP3 vs FREQUENCY & TEMPERATURE (1)
@ VDS=4V, IDS=15mA

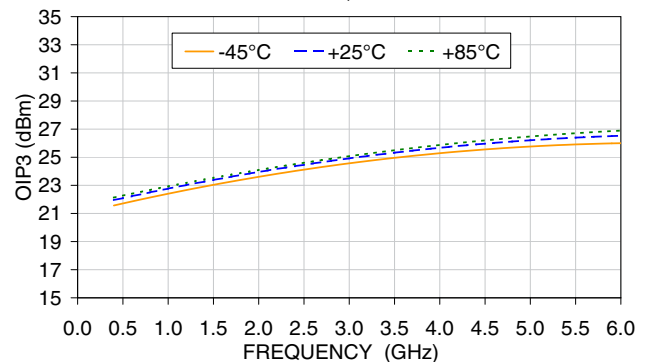

(1) Includes test board loss, set-up and conditions per Figure 1.
 (2) Measured using HP4155B semiconductor parameter analyzer.
 (3) F Min is minimum Noise Figure.
 (4) Drain current was allowed to increase during compression measurement.



TYPICAL PERFORMANCE CURVES

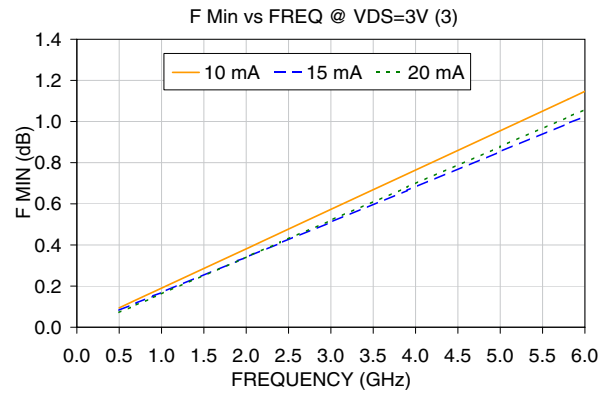
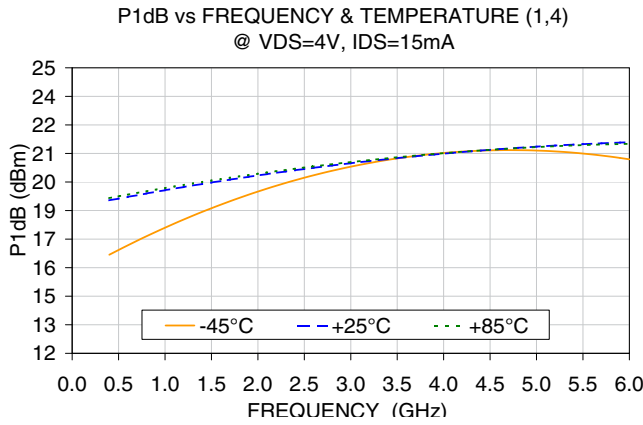

- (1) Includes test board loss, set-up and conditions per Figure 1.
- (2) Measured using HP4155B semiconductor parameter analyzer.
- (3) F Min is minimum Noise Figure.
- (4) Drain current was allowed to increase during compression measurement.

REFERENCE PLANE LOCATION FOR S AND NOISE PARAMETERS (SEE DATA IN PAGES 8-11)

(Refer to Application Note AN-60-040)

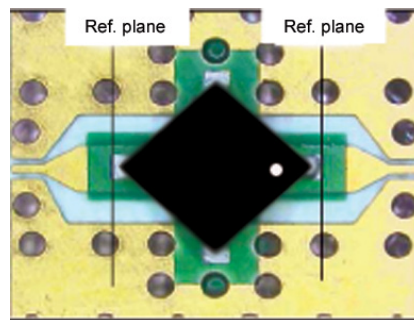

Fig 3. Reference Plane Location

Noise parameters were measured over 0.5 to 6 GHz by Modelithics® using a solid state tuner-based NP noise parameter test system available from Maury Microwave. F Min, optimum source reflection coefficient and noise resistance values are calculated values based on a set of measurements made at approximately 16 different impedances. Some data smoothing was applied to arrive at the presented data set.

S-parameters were measured by Modelithics® on an Anritsu Lightning vector network analyzer over 0.1 to 18GHz using 350um pitch RF probes from GGB industries combined with customized thru-reflect-line (TRL) calibration standards. The reference plane is at the device package leads, as shown in the picture.



ULTRA LOW NOISE, LOW CURRENT

E-PHEMT Transistor

TAV-551+

Mini-Circuits

TYPICAL S-PARAMETERS, $V_{DS}=3V$ AND $I_{DS}=10\text{ MA}$ (FIG. 3)

Freq. (GHz)	S11		S21			S12		S22		MSG/MAG (dB)
	Mag.	Ang.	Mag.	Mag (dB)	Ang.	Mag.	Ang.	Mag.	Ang.	
0.1	1.00	-12.7	14.21	23.05	172.0	0.011	81.4	0.75	-8.17	31.2
0.5	0.93	-58.8	12.37	21.85	140.6	0.045	57.0	0.66	-36.56	24.3
0.9	0.84	-94.8	9.95	19.96	116.8	0.066	37.7	0.54	-57.56	21.8
1.0	0.82	-102.7	9.41	19.47	111.7	0.070	34.1	0.51	-62.13	21.3
1.5	0.75	-134.4	7.24	17.20	90.7	0.080	19.3	0.39	-79.90	19.6
1.9	0.72	-153.9	6.03	15.61	77.1	0.084	11.1	0.33	-91.22	18.6
2.0	0.72	-158.2	5.79	15.25	74.0	0.084	9.1	0.32	-93.86	18.4
2.5	0.71	-177.5	4.80	13.62	59.6	0.087	1.4	0.27	-105.83	17.4
3.0	0.70	165.7	4.09	12.23	46.4	0.089	-4.9	0.23	-117.43	16.6
4.0	0.69	137.4	3.15	9.96	22.1	0.092	-15.5	0.18	-140.41	15.3
5.0	0.70	112.9	2.57	8.19	-0.6	0.096	-24.3	0.15	-167.87	13.1
6.0	0.72	90.6	2.17	6.71	-22.6	0.103	-32.7	0.14	158.44	11.2
7.0	0.74	69.7	1.87	5.42	-44.2	0.111	-41.9	0.15	121.27	10.0
8.0	0.77	49.8	1.63	4.22	-65.5	0.121	-52.1	0.19	88.24	9.0
9.0	0.80	30.2	1.42	3.02	-86.7	0.131	-64.6	0.26	60.44	8.5
10.0	0.84	10.7	1.23	1.79	-108.1	0.139	-78.2	0.34	36.60	8.5
11.0	0.87	-8.2	1.05	0.46	-129.3	0.144	-93.1	0.43	15.42	8.7
12.0	0.90	-26.4	0.90	-0.93	-150.0	0.145	-108.6	0.51	-3.96	7.9
13.0	0.91	-44.3	0.76	-2.40	-170.6	0.143	-124.7	0.59	-22.58	7.2
14.0	0.93	-61.0	0.63	-3.97	169.7	0.137	-140.6	0.65	-40.31	6.6
15.0	0.94	-73.8	0.53	-5.58	153.5	0.130	-153.7	0.72	-54.43	6.1
16.0	0.96	-83.9	0.43	-7.26	139.6	0.119	-163.9	0.76	-66.50	5.6
17.0	0.96	-95.1	0.36	-8.93	124.9	0.109	-175.0	0.80	-79.64	5.2
18.0	0.95	-106.9	0.29	-10.68	109.7	0.100	174.4	0.83	-93.87	4.7

TYPICAL NOISE PARAMETERS, $V_{DS}=3V$ AND $I_{DS}=10\text{ MA}$ (FIG. 3)

Freq. (GHz)	F Min. (dB)	G _{Opt} (Magnitude)	G _{Opt} (Angle)	R _n /50	G _a Associated Gain (dB)
0.5	0.09	0.37	25.6	0.10	25.8
0.7	0.13	0.38	35.9	0.09	23.8
0.9	0.17	0.40	46.2	0.08	22.0
1.0	0.19	0.41	51.2	0.07	21.2
1.9	0.36	0.46	95.0	0.04	16.3
2.0	0.38	0.47	99.7	0.04	16.0
2.4	0.46	0.49	118.1	0.04	14.7
3.0	0.57	0.52	144.5	0.04	13.3
3.9	0.75	0.54	-178.4	0.06	11.8
5.0	0.96	0.56	-137.2	0.11	10.7
5.8	1.11	0.55	-110.1	0.16	10.0
6.0	1.15	0.55	-103.7	0.18	9.8

F Min.: Minimum Noise Figure
 G_{Opt}: Optimum Source Reflection Coefficient
 R_n: Equivalent noise resistance

MAXIMUM STABLE GAIN (MSG)/MAXIMUM AVAILABLE GAIN (MAG) vs. FREQUENCY
 $V_{DS}=3V$ & $I_{DS}=10\text{ mA}$

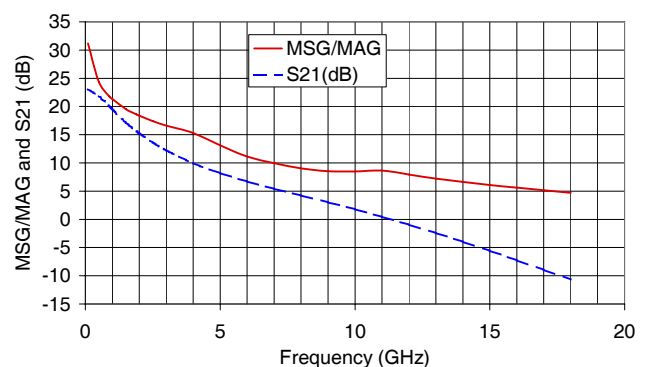



ULTRA LOW NOISE, LOW CURRENT

E-PHEMT Transistor

TAV-551+

Mini-Circuits

TYPICAL S-PARAMETERS, $V_{DS}=3V$ AND $I_{DS}=15 MA$ (FIG. 3)

Freq. (GHz)	S11		S21			S12		S22		MSG/MAG (dB)
	Mag.	Ang.	Mag.	Mag (dB)	Ang.	Mag.	Ang.	Mag.	Ang.	
0.1	1.00	-14.1	17.46	24.84	171.0	0.011	81.8	0.69	-9.71	32.1
0.5	0.91	-64.6	14.68	23.33	137.4	0.043	55.7	0.59	-42.24	25.4
0.9	0.81	-101.9	11.40	21.14	113.2	0.059	36.4	0.46	-65.39	22.8
1.0	0.79	-109.9	10.71	20.59	108.2	0.062	33.0	0.43	-70.37	22.4
1.5	0.73	-141.1	8.03	18.10	87.9	0.071	20.5	0.33	-89.71	20.6
1.9	0.70	-159.8	6.62	16.42	74.9	0.075	13.5	0.27	-102.27	19.5
2.0	0.70	-163.9	6.34	16.04	71.9	0.075	12.0	0.26	-105.26	19.2
2.5	0.69	177.6	5.23	14.37	58.1	0.079	5.7	0.22	-119.09	18.2
3.0	0.68	161.5	4.43	12.94	45.3	0.082	0.2	0.18	-132.67	17.3
4.0	0.68	134.3	3.39	10.62	21.8	0.089	-9.0	0.14	-160.91	15.8
5.0	0.69	110.6	2.76	8.82	-0.4	0.097	-18.2	0.12	166.12	13.1
6.0	0.71	88.9	2.32	7.31	-21.8	0.107	-27.8	0.13	130.04	11.4
7.0	0.74	68.4	1.99	6.00	-43.0	0.117	-38.6	0.16	97.11	10.2
8.0	0.76	48.8	1.74	4.78	-63.8	0.127	-50.4	0.21	70.19	9.3
9.0	0.80	29.5	1.51	3.58	-84.6	0.137	-64.1	0.28	47.25	8.8
10.0	0.83	10.2	1.31	2.35	-105.6	0.144	-78.3	0.36	26.76	8.6
11.0	0.87	-8.5	1.13	1.06	-126.3	0.147	-93.4	0.44	7.89	8.8
12.0	0.89	-26.6	0.97	-0.29	-146.6	0.147	-109.1	0.52	-9.88	8.2
13.0	0.91	-44.3	0.82	-1.70	-167.0	0.144	-125.0	0.58	-27.32	7.6
14.0	0.93	-61.0	0.69	-3.17	173.4	0.138	-140.6	0.64	-44.02	7.0
15.0	0.94	-73.7	0.58	-4.69	157.4	0.130	-153.7	0.70	-57.24	6.5
16.0	0.96	-83.9	0.49	-6.26	143.3	0.118	-163.6	0.75	-68.66	6.1
17.0	0.96	-94.9	0.41	-7.84	128.5	0.109	-175.1	0.79	-81.23	5.7
18.0	0.95	-106.8	0.34	-9.48	112.8	0.100	174.2	0.81	-95.04	5.2

TYPICAL NOISE PARAMETERS, $V_{DS}=3V$ AND $I_{DS}=15 MA$ (FIG. 3)

Freq. (GHz)	F Min. (dB)	G _{Opt} (Magnitude)	G _{Opt} (Angle)	Rn/50	G _a Associated Gain (dB)
0.5	0.08	0.35	25.2	0.08	26.4
0.7	0.12	0.36	35.8	0.07	24.3
0.9	0.15	0.37	46.2	0.06	22.6
1.0	0.17	0.38	51.3	0.06	21.8
1.9	0.32	0.42	95.9	0.04	17.0
2.0	0.34	0.43	100.7	0.04	16.6
2.4	0.41	0.44	119.4	0.04	15.3
3.0	0.51	0.47	146.3	0.04	13.9
3.9	0.67	0.49	-176.0	0.06	12.4
5.0	0.85	0.50	-134.1	0.11	11.1
5.8	0.99	0.51	-106.5	0.16	10.3
6.0	1.03	0.50	-100.0	0.17	10.1

F Min.: Minimum Noise Figure
 G_{Opt}: Optimum Source Reflection Coefficient
 Rn: Equivalent noise resistance

MAXIMUM STABLE GAIN (MSG)/MAXIMUM AVAILABLE GAIN (MAG) vs. FREQUENCY
 $V_{DS}=3V$ & $I_{DS}=15mA$

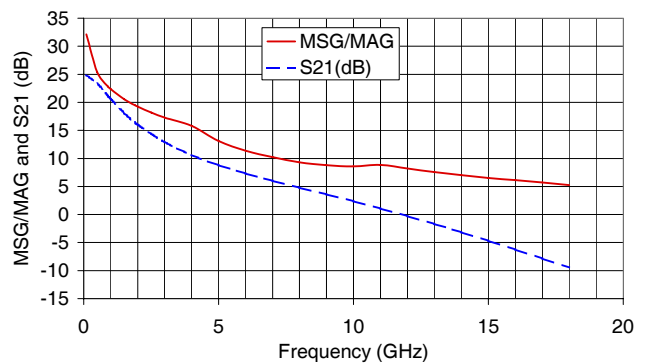



ULTRA LOW NOISE, LOW CURRENT

E-PHEMT Transistor

TAV-551+

Mini-Circuits

TYPICAL S-PARAMETERS, $V_{DS}=3V$ AND $I_{DS}=20\text{ MA}$ (FIG. 3)

Freq. (GHz)	S11		S21			S12		S22		MSG/MAG (dB)
	Mag.	Ang.	Mag.	Mag (dB)	Ang.	Mag.	Ang.	Mag.	Ang.	
0.1	1.00	-14.9	19.82	25.94	170.5	0.010	87.2	0.65	-11.30	32.8
0.5	0.90	-68.4	16.23	24.20	135.2	0.040	53.6	0.54	-46.49	26.1
0.9	0.80	-106.4	12.30	21.80	111.0	0.055	36.2	0.41	-71.23	23.5
1.0	0.78	-114.4	11.51	21.22	106.1	0.057	33.3	0.38	-76.62	23.0
1.5	0.72	-145.0	8.52	18.61	86.2	0.065	22.0	0.29	-97.45	21.2
1.9	0.69	-163.4	6.98	16.88	73.6	0.069	16.0	0.24	-111.25	20.0
2.0	0.69	-167.3	6.68	16.49	70.7	0.070	14.5	0.23	-114.53	19.8
2.5	0.68	174.7	5.49	14.78	57.2	0.075	9.1	0.19	-129.96	18.6
3.0	0.67	159.1	4.64	13.34	44.7	0.079	4.0	0.16	-145.36	17.7
4.0	0.67	132.5	3.54	10.98	21.6	0.088	-5.1	0.13	-177.47	16.1
5.0	0.69	109.3	2.88	9.17	-0.2	0.098	-14.7	0.12	147.40	13.2
6.0	0.71	87.9	2.41	7.65	-21.4	0.109	-25.2	0.14	113.68	11.5
7.0	0.73	67.7	2.07	6.32	-42.3	0.120	-37.1	0.18	85.11	10.4
8.0	0.76	48.3	1.80	5.11	-62.9	0.132	-49.5	0.23	61.45	9.5
9.0	0.79	29.2	1.57	3.89	-83.3	0.141	-63.7	0.29	40.79	8.9
10.0	0.83	10.0	1.36	2.67	-104.0	0.147	-78.5	0.37	21.58	8.7
11.0	0.86	-8.7	1.17	1.39	-124.4	0.149	-93.8	0.45	3.68	9.0
12.0	0.89	-26.6	1.01	0.07	-144.6	0.148	-109.3	0.52	-13.33	8.3
13.0	0.91	-44.3	0.86	-1.30	-164.7	0.145	-125.2	0.59	-30.14	7.7
14.0	0.93	-61.0	0.73	-2.74	175.9	0.139	-140.7	0.64	-46.34	7.2
15.0	0.94	-73.6	0.62	-4.20	160.0	0.130	-153.6	0.70	-59.12	6.8
16.0	0.96	-83.7	0.52	-5.72	146.0	0.119	-163.2	0.74	-70.10	6.4
17.0	0.96	-94.8	0.44	-7.22	131.2	0.109	-174.6	0.78	-82.42	6.0
18.0	0.95	-106.7	0.36	-8.78	115.2	0.101	174.7	0.80	-95.97	5.6

TYPICAL NOISE PARAMETERS, $V_{DS}=3V$ AND $I_{DS}=20\text{ MA}$ (FIG. 3)

Freq. (GHz)	F Min. (dB)	G _{Opt} (Magnitude)	G _{Opt} (Angle)	Rn/50	G _a Associated Gain (dB)
0.5	0.07	0.30	16.9	0.09	26.1
0.7	0.11	0.32	28.9	0.08	24.3
0.9	0.14	0.33	40.7	0.07	22.6
1.0	0.16	0.34	46.5	0.06	21.9
1.9	0.32	0.40	96.1	0.04	17.3
2.0	0.34	0.40	101.3	0.04	17.0
2.4	0.41	0.43	121.6	0.03	15.8
3.0	0.52	0.45	150.2	0.04	14.4
3.9	0.68	0.48	-170.9	0.05	12.9
5.0	0.88	0.50	-129.8	0.10	11.5
5.8	1.02	0.50	-104.4	0.16	10.5
6.0	1.06	0.50	-98.7	0.17	10.3

F Min.: Minimum Noise Figure
 G_{Opt}: Optimum Source Reflection Coefficient
 Rn: Equivalent noise resistance

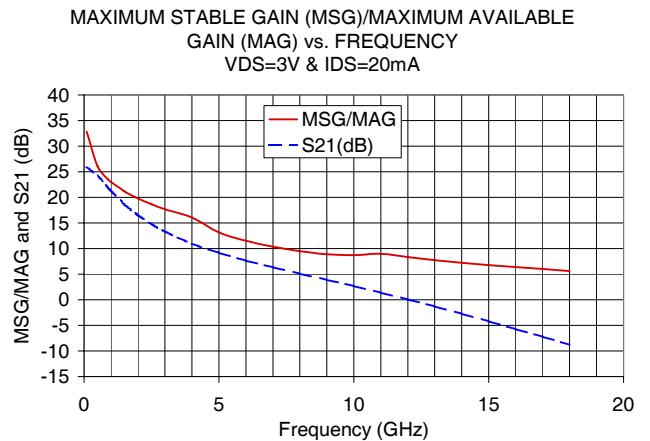



ULTRA LOW NOISE, LOW CURRENT

E-PHEMT Transistor

TAV-551+

Mini-Circuits

TYPICAL S-PARAMETERS, $V_{DS}=4V$ AND $I_{DS}=15\text{ MA}$ (FIG. 3)

Freq. (GHz)	S11		S21			S12		S22		MSG/MAG (dB)
	Mag.	Ang.	Mag.	Mag (dB)	Ang.	Mag.	Ang.	Mag.	Ang.	
0.1	1.00	-14.1	17.47	24.85	171.0	0.010	82.0	0.70	-9.56	32.2
0.5	0.91	-64.1	14.72	23.36	137.6	0.041	55.0	0.60	-41.18	25.5
0.9	0.81	-101.4	11.45	21.18	113.4	0.059	36.8	0.47	-63.63	22.9
1.0	0.79	-109.3	10.76	20.64	108.4	0.061	33.6	0.44	-68.52	22.5
1.5	0.73	-140.6	8.09	18.16	88.1	0.070	20.6	0.33	-87.06	20.7
1.9	0.70	-159.4	6.67	16.48	75.0	0.073	13.9	0.28	-99.01	19.6
2.0	0.70	-163.5	6.39	16.11	72.1	0.074	12.3	0.26	-101.74	19.3
2.5	0.69	177.9	5.27	14.43	58.2	0.078	5.8	0.22	-114.83	18.3
3.0	0.68	161.9	4.47	13.01	45.4	0.081	0.5	0.19	-127.53	17.4
4.0	0.68	134.5	3.42	10.69	21.8	0.088	-8.7	0.14	-153.81	15.9
5.0	0.69	110.7	2.78	8.89	-0.3	0.095	-17.7	0.12	174.29	13.2
6.0	0.71	89.0	2.34	7.40	-21.8	0.105	-27.0	0.12	137.36	11.5
7.0	0.74	68.5	2.02	6.09	-43.0	0.116	-37.9	0.15	102.05	10.3
8.0	0.76	48.9	1.75	4.88	-63.9	0.126	-49.4	0.20	73.74	9.5
9.0	0.80	29.6	1.53	3.69	-84.8	0.136	-63.1	0.26	49.94	8.9
10.0	0.83	10.3	1.33	2.47	-105.8	0.143	-77.3	0.34	28.74	9.0
11.0	0.87	-8.5	1.15	1.18	-126.6	0.147	-92.5	0.43	9.54	8.9
12.0	0.89	-26.6	0.98	-0.15	-147.1	0.148	-108.1	0.51	-8.53	8.2
13.0	0.91	-44.5	0.84	-1.55	-167.6	0.145	-124.3	0.57	-26.10	7.6
14.0	0.93	-61.3	0.71	-3.03	172.6	0.140	-140.1	0.64	-43.02	7.0
15.0	0.94	-74.1	0.59	-4.56	156.4	0.131	-153.3	0.70	-56.54	6.5
16.0	0.96	-84.4	0.49	-6.15	142.1	0.120	-163.4	0.75	-68.00	6.1
17.0	0.96	-95.6	0.41	-7.73	127.1	0.110	-174.8	0.79	-80.81	5.7
18.0	0.95	-107.5	0.34	-9.39	111.2	0.101	173.9	0.81	-94.81	5.3

TYPICAL NOISE PARAMETERS, $V_{DS}=4V$ AND $I_{DS}=15\text{ MA}$ (FIG. 3)

Freq. (GHz)	F Min. (dB)	GOpt (Magnitude)	GOpt (Angle)	Rn/50	Ga Associated Gain (dB)
0.5	0.08	0.36	24.7	0.08	26.4
0.7	0.12	0.37	35.2	0.07	24.4
0.9	0.15	0.38	45.5	0.06	22.6
1.0	0.17	0.38	50.6	0.06	21.8
1.9	0.32	0.42	95.1	0.04	17.0
2.0	0.33	0.43	99.8	0.04	16.6
2.4	0.40	0.44	118.4	0.04	15.4
3.0	0.50	0.46	145.3	0.04	13.9
3.9	0.65	0.48	-176.9	0.06	12.4
5.0	0.84	0.50	-134.8	0.10	11.2
5.8	0.98	0.50	-107.0	0.15	10.3
6.0	1.01	0.50	-100.4	0.17	10.1

F Min.: Minimum Noise Figure
 GOpt: Optimum Source Reflection Coefficient
 Rn: Equivalent noise resistance

MAXIMUM STABLE GAIN (MSG)/MAXIMUM AVAILABLE GAIN (MAG) vs. FREQUENCY
 $V_{DS}=4V$ & $I_{DS}=15\text{ mA}$

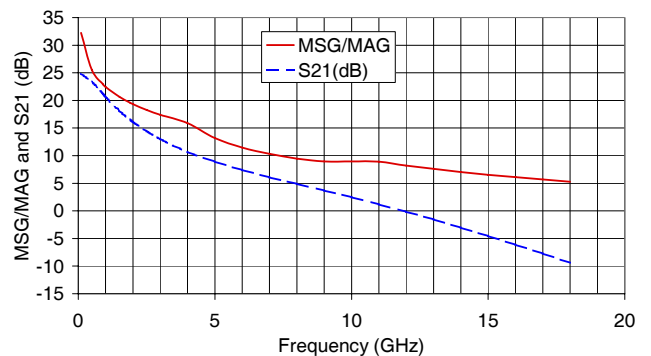



ULTRA LOW NOISE, LOW CURRENT

E-PHEMT Transistor

TAV-551+

RECOMMENDED APPLICATION CIRCUIT

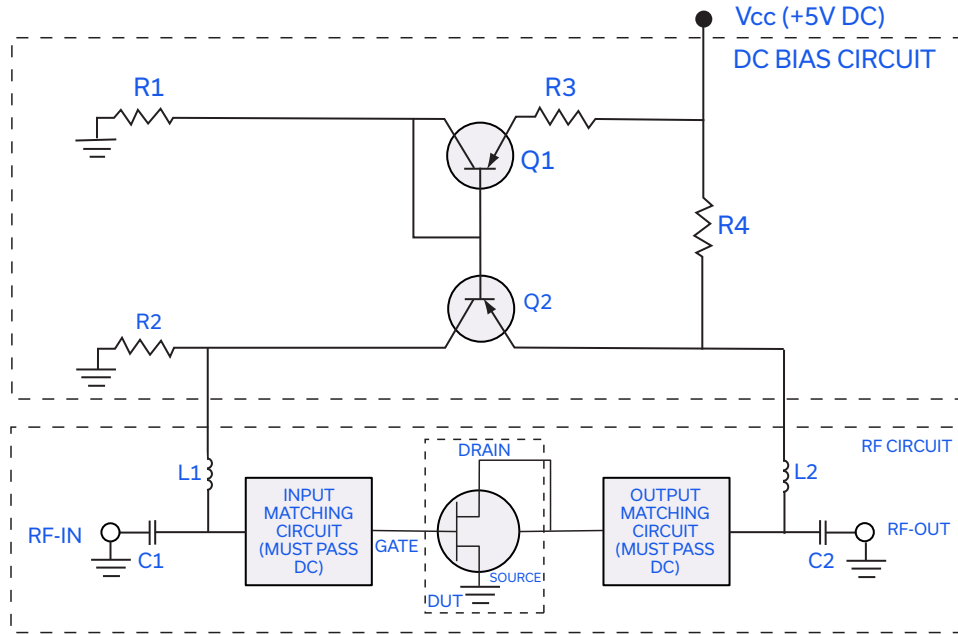

VDS, V (nom)	3	4
IDS, mA (nom)	15mA	15mA
R1	4320	4320
R2	4320	4320
R3	3570	1210
R4	133	68.1
Q1	MMBT3906*	MMBT3906*
Q2	MMBT3906*	MMBT3906*
C1	0.01 μ F	0.01 μ F
C2	0.01 μ F	0.01 μ F
L1**	840nH	840nH
L2**	840nH	840nH

* Fairchild Semiconductor™ part number
 ** Piconics™ part number CC45T47K240G5

OPTIMIZED AMPLIFIER CIRCUITS

For band specific, drop-in modules, and as an alternative to designing circuits, please refer to Mini-Circuits TAMP and RAMP series models which are based upon SAV/TAV E-PHEMT's and include all DC blocking, bias, matching and stabilization circuitry, without need for any external components.

PRODUCT MARKING



← White Ink Marking
 ← Body (Black)

Marking may contain other features or characters for internal lot control





ULTRA LOW NOISE, HIGH CURRENT

E-PHEMT Transistor

TAV-551+

Mini-Circuits

ADDITIONAL DETAILED TECHNICAL INFORMATION IS AVAILABLE ON OUR DASH BOARD. TO ACCESS [CLICK HERE](#)

Performance Data	Data Table Swept Graphs S-Parameter (S2P Files) Data Set (.zip file)
Case Style	FG873 Plastic low profile 3mm x 3mm, lead finish: tin/silver/nickel
Tape & Reel Standard quantities available on reel	F68 7" reels with 20, 50, 100, 200, 500,1K,2K or 3K devices
Suggested Layout for PCB Design	PL-301
Evaluation Board	TB-154+
Environmental Ratings	ENV08T2

ESD RATING

Human Body Model (HBM): Class 1A (250 V to < 500 V) in accordance with ANSI/ESD STM 5.1 - 2001

Machine Model (MM): Class M1 (40 V) in accordance with ANSI/ESD STM 5.2 - 1999

MSL RATING

Moisture Sensitivity: MSL1 in accordance with IPC/JEDECJ-STD-020D

MSL TEST FLOW CHART

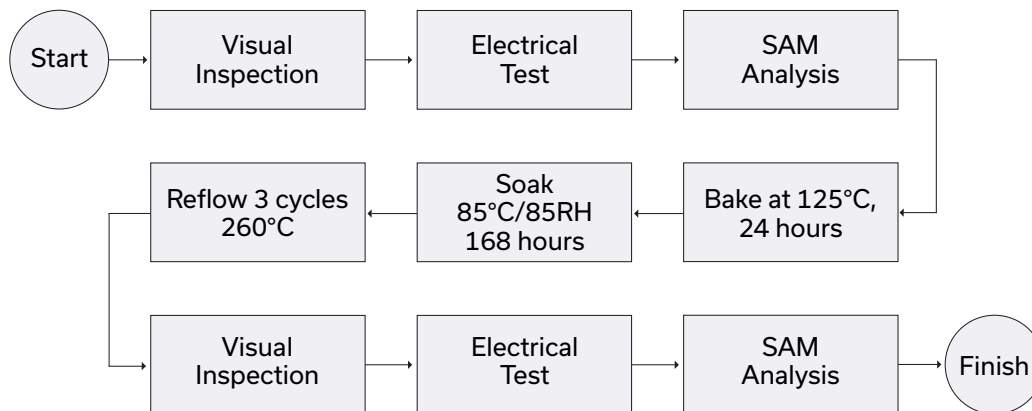

- NOTES**
- A. Performance and quality attributes and conditions not expressly stated in this specification document are intended to be excluded and do not form a part of this specification document.
 - B. Electrical specifications and performance data contained in this specification document are based on Mini-Circuit's applicable established test performance criteria and measurement instructions.
 - C. The parts covered by this specification document are subject to Mini-Circuits standard limited warranty and terms and conditions (collectively, "Standard Terms"); Purchasers of this part are entitled to the rights and benefits contained therein. For a full statement of the standard. Terms and the exclusive rights and remedies thereunder, please visit Mini-Circuits' website at www.minicircuits.com/MCLStore/terms.jsp

