

SUMMARY



Image is for illustrative purpose only

Wires

Low voltage 10

Series 3K
Termination type Female solder
IP rating 68 when mated
AWG wire size 28.00 - 20.00
Cable Ø 0.00 - 0.00 mm
Status active
Matching parts [FGG.3K.310.CLAC95](#)

Download

[Request a quote](#)

[Catalog](#)

TECHNICAL DETAILS

Mechanics

Shell Style/Model EE*: Fixed receptacle, nut fixing (back panel mounting)
Keying 1 key (alpha=0, plug: male contacts, receptacle: female contacts)
Housing Material Brass (chrome plated [SAE AMS 2460]) shell, collet nut and latch sleeve, nickel plated [SAE AMS QQ N 290] brass mid pieces
Weight 62.01 g

Performance

Configuration 3K.310 : 10 Low Voltage
Insulator L: PEEK (UL 94 / V-0/1.5)
Rated Current 12 Amps

Specifications

Contact Type: Solder
Contact Dia.: 1.3 mm (0.051in)
Bucket Dia.: 1 mm (0.039in)
Max. Solid Conductor: 0.5 mm² (AWG 20)
Max. Stranded Conductor: 0.5 mm² (AWG 20)
R (max): 3.6 mOhm
Vtest (contact-shell): 900 V (AC), 1270 V (DC)
Vtest (contact-contact): 1250 V (AC), 1770 V (DC)

LEMO products and services are provided "as is". LEMO makes no warranties or representations with regard to LEMO product & services or use of them, express, implied or statutory, including for accuracy, completeness, or security. The user is fully responsible for his products and applications using LEMO components.

Others

Endurance (Shell): 5000 mating cycles
 Temp (min / max): -55°C / +200°C
 Humidity (max): <=95% [at 60 deg C / 140 F]
 Vibration: 15 g [10 Hz - 2000 Hz]
 Shock Resistance: 100 g [6 ms]
 Climatical Category: 50/175/21
 Shielding (min): 95 dB (10 MHz)
 Shielding (min): 80 dB (1 GHz)
 Salt Spray Corrosion: >1000 hr

DRAWINGS

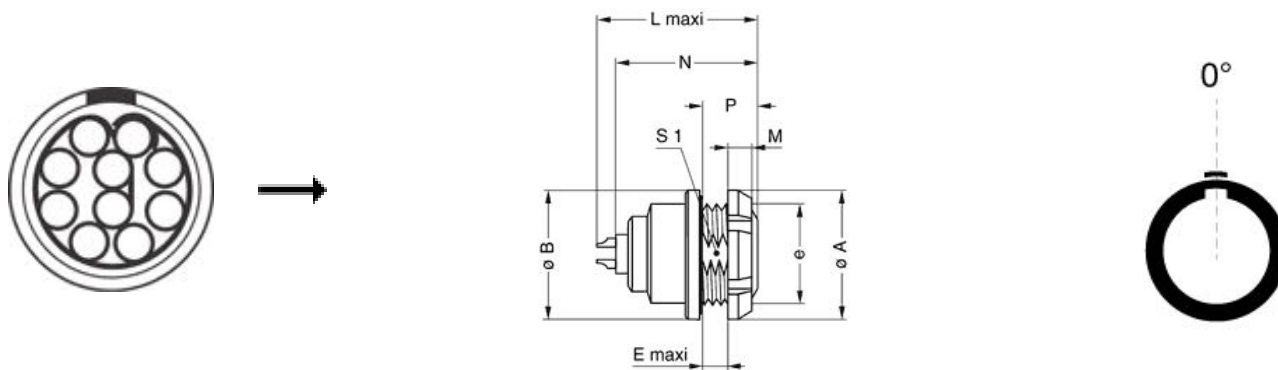

Dimensions

	A	B	E	L	M	N	P	S1	e
mm.	30	31	7.5	36.2	4.5	33.6	12	22.5	M24x1.0
in.	1,18	1,22	0,30	1,43	0,18	1,32	0,47	0,89	











RECOMMENDED BY LEMO

Tools

Spanner wrench: [Socket for torque wrench DCM.65.200.AZ and DCM.65.270.AZ](#)

LEMO products and services are provided "as is". LEMO makes no warranties or representations with regard to LEMO product & services or use of them, express, implied or statutory, including for accuracy, completeness, or security. The user is fully responsible for his products and applications using LEMO components.

Cables

CMN.10.T20.080PGZE		Grey	
CMN.10.T20.080PNZE			
CMN.10.T20.080QGC	TPR	Grey	
CMN.10.T22.068QGZE	TPR (medical)	Grey	
CMN.10.T28.052PGZE		Grey	
CMN.10.T28.052PNZE			
CMN.10.T28.053QGZE	TPR (medical)	Grey	
110220	PVC	Black	
110240	PTFE	White	
110260	PTFE	White	
110280	PVC	Black	
210140	PVC	Grey	
210240	PVC	Black	
210250	PVC	Grey	
210260	PVC	Black	

LEMO products and services are provided "as is". LEMO makes no warranties or representations with regard to LEMO product & services or use of them, express, implied or statutory, including for accuracy, completeness, or security. The user is fully responsible for his products and applications using LEMO components.