

U_B12 BI2.SchDoc
U_B13 BI3.SchDoc
U_B14 BI4.SchDoc
U_B15 BI5.SchDoc
U_B16 BI6.SchDoc
U_B34 B34.SchDoc

U_FPGA-MGT FPGA-MGT.SchDoc
U_FPGA-CFG FPGA-CFG.SchDoc
U_FPGA-MISC FPGA-MISC.SchDoc
U_FPGA-PWR FPGA-PWR.SchDoc

U_PWR1 PWR1.SchDoc
U_PWR2 PWR2.SchDoc

U_Clock Clock.SchDoc

U_B2B-Connectors B2B-Connectors.SchDoc

U_B33 B33.SchDoc

Mount.Hole 3.2mm Mount.Hole 3.2mm

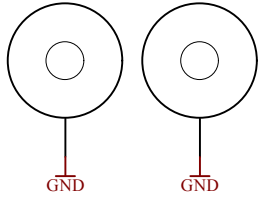

Mount.Hole 3.2mm Mount.Hole 3.2mm

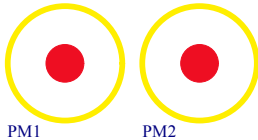
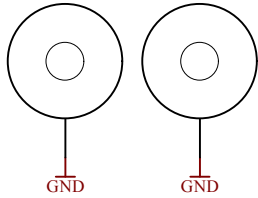

PM1 PM2

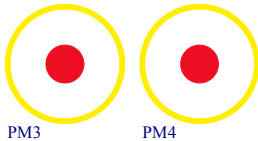

PM3 PM4

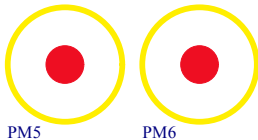

PM5 PM6

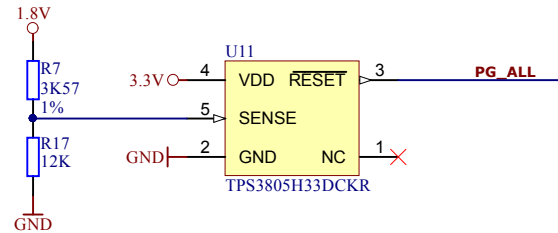
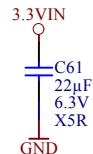
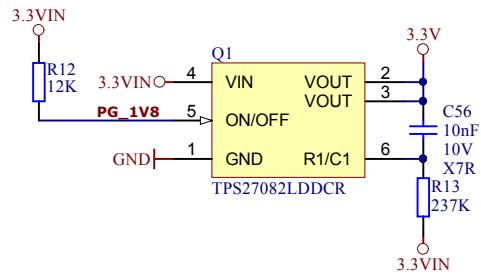
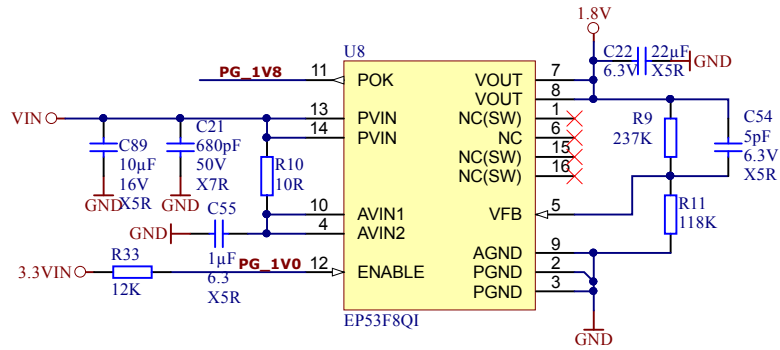

Top of Board

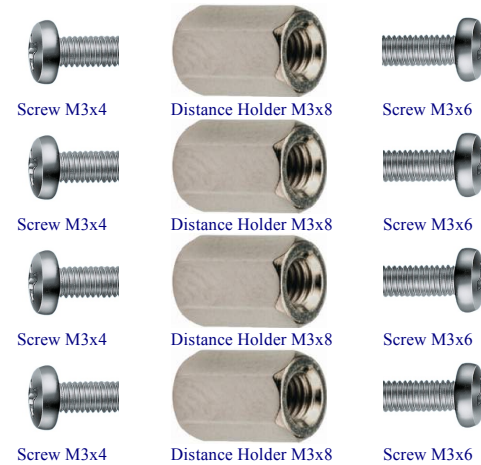

	Title: TE0741		
	A4	Number: TE0741 TE0741-070-2IF	Rev. 02
	Date: 2013-11-06	Copyright: 2013 Trenz Electronic GmbH	Page1 of 15
	Filename: TE0741.SchDoc		

B13 48 IO, 24 LVDS Pairs
B14 8 IO, 3.3V
MGT 3 Lanes

B16 16 IO, 8 LVDS Pairs
MGT 4 + 1 Lanes
B14 4 IO, 3.3V

B15 18 IO, 9 LVDS Pairs
B12 48 IO, 24 LVDS Pairs
B12 2 IO

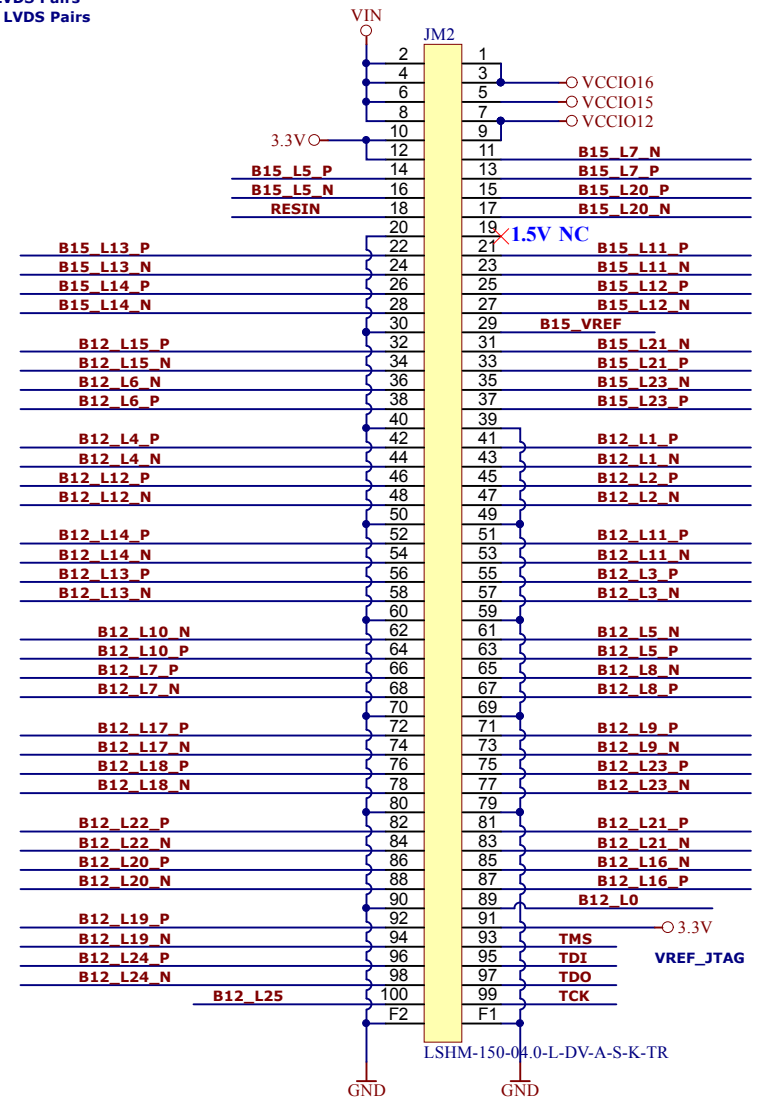
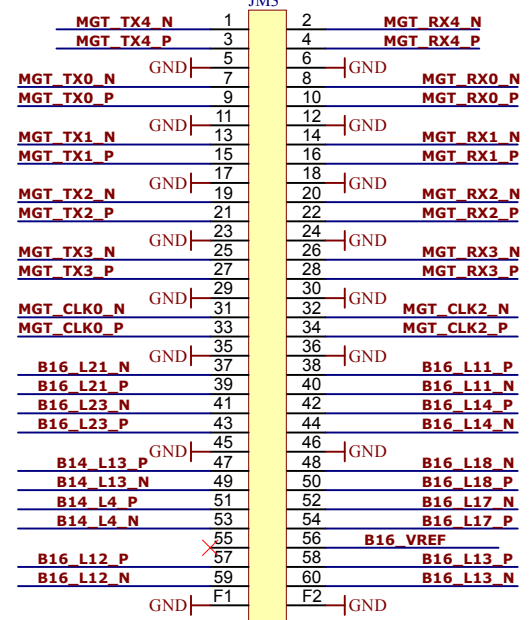
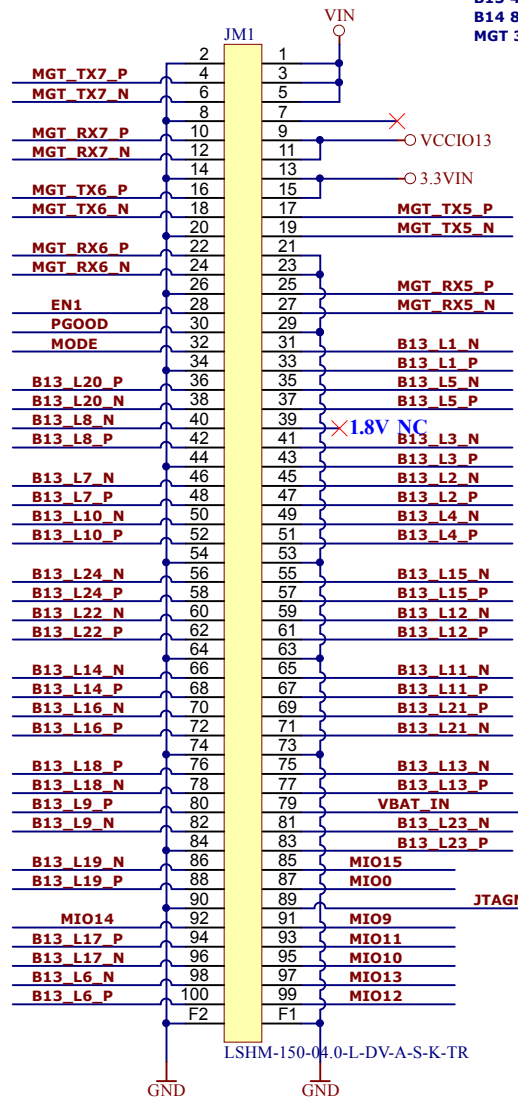

TE0720 Compatibility

MIO0 8 pins => 8 IO B14
 USB D+,D-, vbusen,otg_id => 4 IO B14
 SGMII => MGT
 MIO1(SDCARD) => MGT
 ETH MD1 => MGT
 B34 => B16, MGT
 B35 => B13
 B13 => B12
 B33 => B15

Clock Capable I/O
 All pins named
 Bxx_H_X
 Bxx_I_X
 Bxx_O_X
 Bxx_T_X
 Bxx_V_X
 Bxx_W_X
 Bxx_X_X
 Bxx_Y_X
 Bxx_Z_X
 Are Clock Capable I/O's



Title: TE0741		
A4	Number: TE0741 TE0741-070-2IF	Rev. 02
Date: 2013-11-06	Copyright: 2013 Trenz Electronic GmbH	Page2 of 15
Filename: B2B-Connectors.SchDoc		

B12_FIXED (i) △

B12 L11 P
B12 L11 N
B12 L12 P
B12 L12 N
B12 L13 P
B12 L13 N
B12 L14 P
B12 L14 N
B12 L19 P
B12 L19 N
B12 L6 P
B12 L6 N

K70T version does not have this bank!

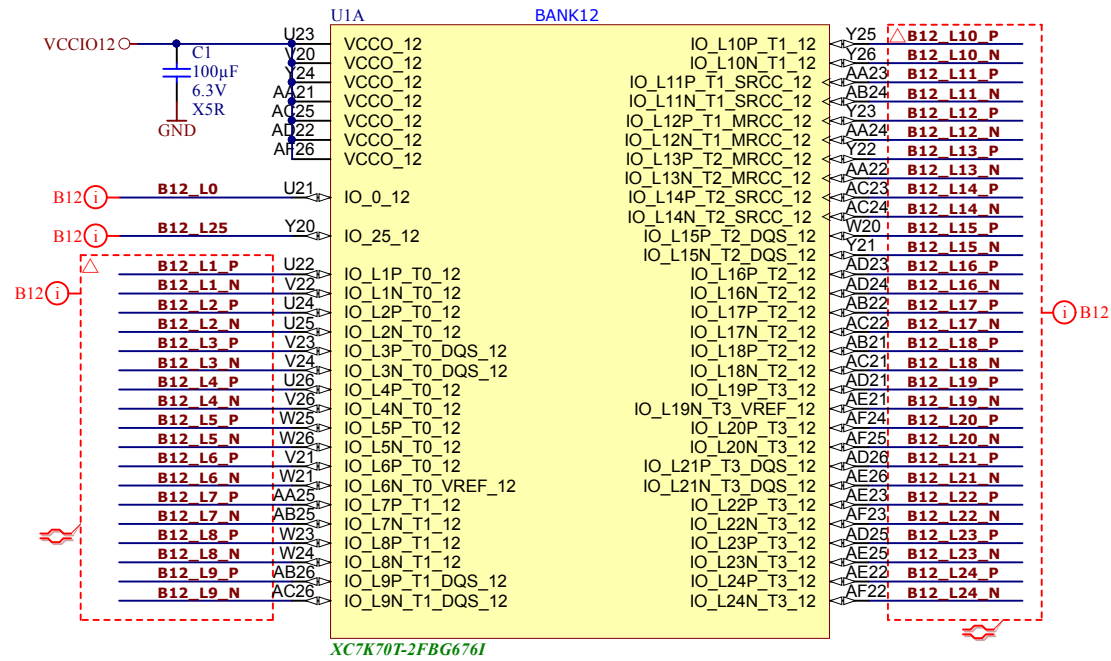

XC7K70T-2FBG676I

	Title: TE0741		
	A4	Number: TE0741 TE0741-070-2IF	Rev. 02
	Date: 2013-11-06	Copyright: 2013 Trenz Electronic GmbH	Page3 of 15
	Filename: B12.SchDoc		

B13_FIXED

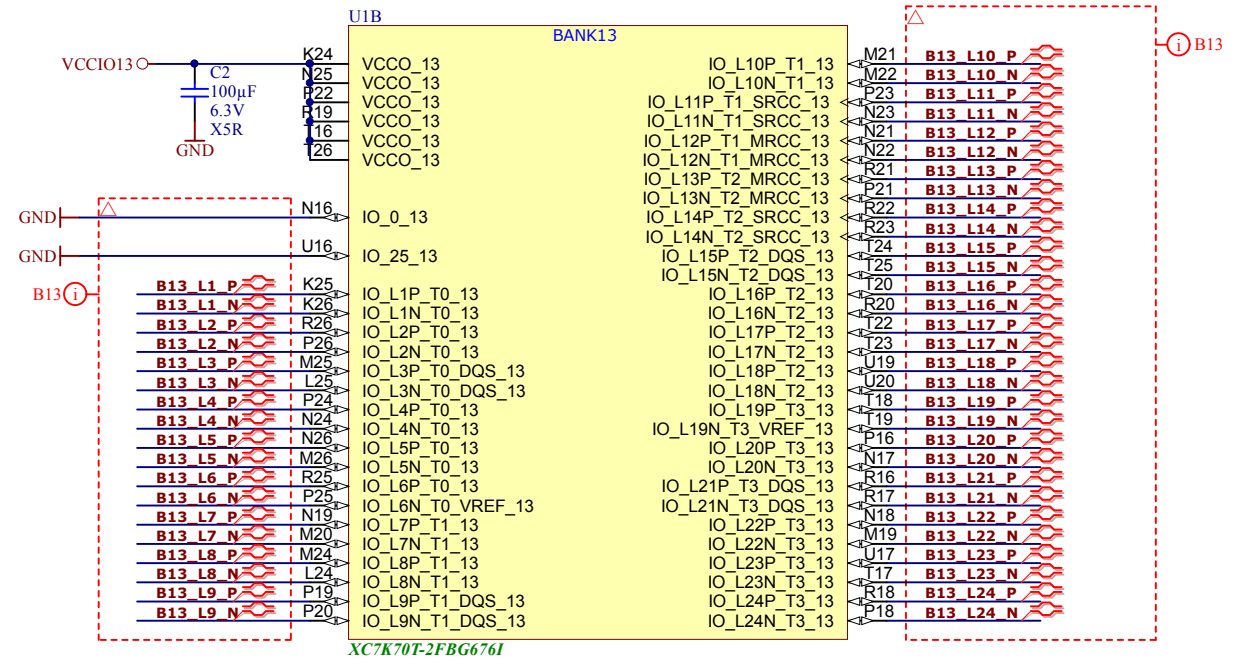
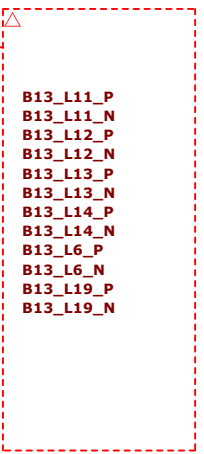

Title: TE0741		
A4	Number: TE0741 TE0741-070-2IF	Rev. 02
Date: 2013-11-06	Copyright: 2013 Trenz Electronic GmbH	Page4 of 15
Filename: B13.SchDoc		

1

2

3

4

UIF

BANK32

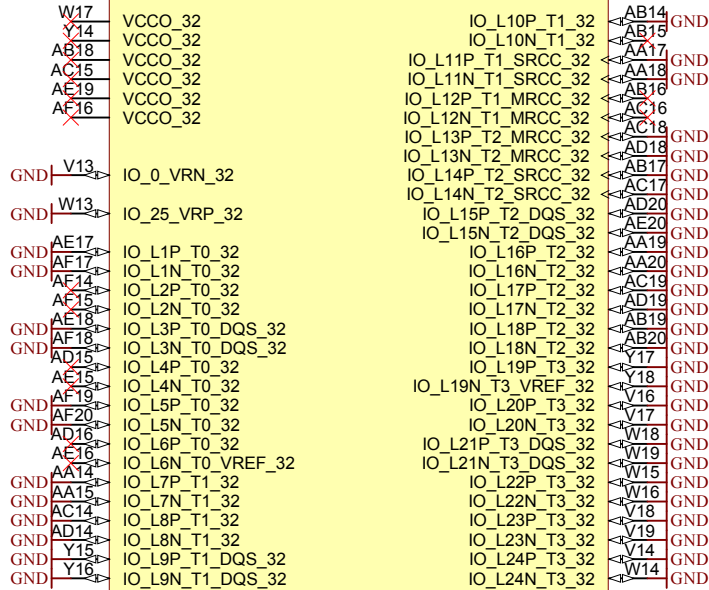

XC7K70T-2FBG6761

UIG

BANK33

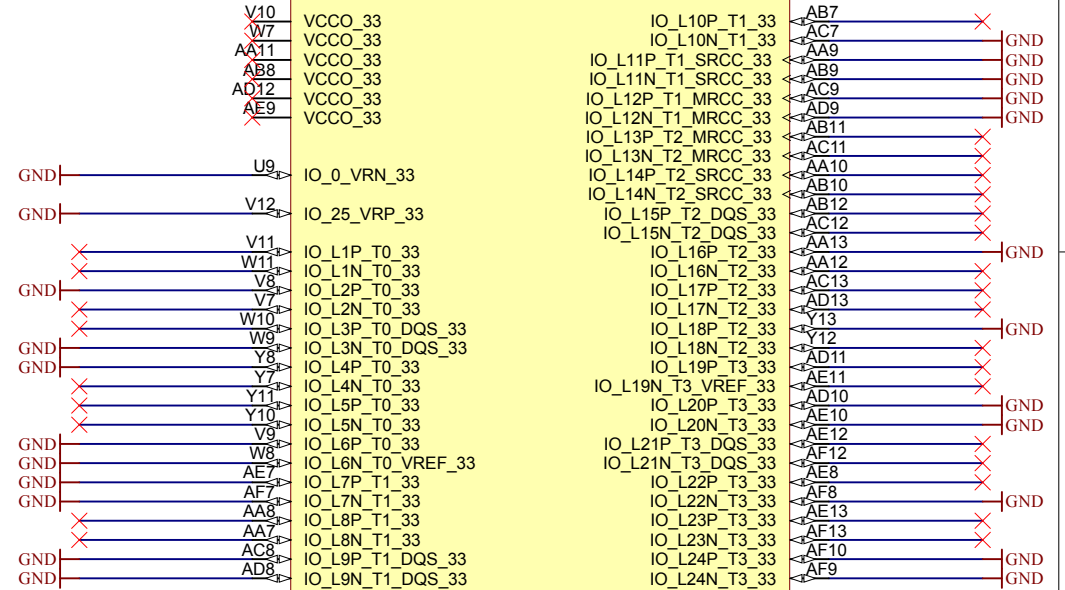

XC7K70T-2FBG6761



Title: TE0741		
A4	Number: TE0741 TE0741-070-2IF	Rev. 02
Date: 2013-11-06	Copyright: 2013 Trenz Electronic GmbH	Page5 of 15
Filename: B33.SchDoc		

1

2

3

4

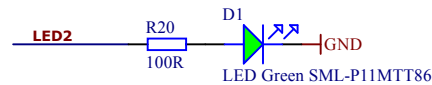
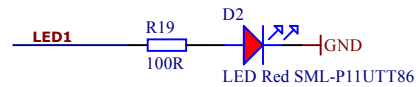
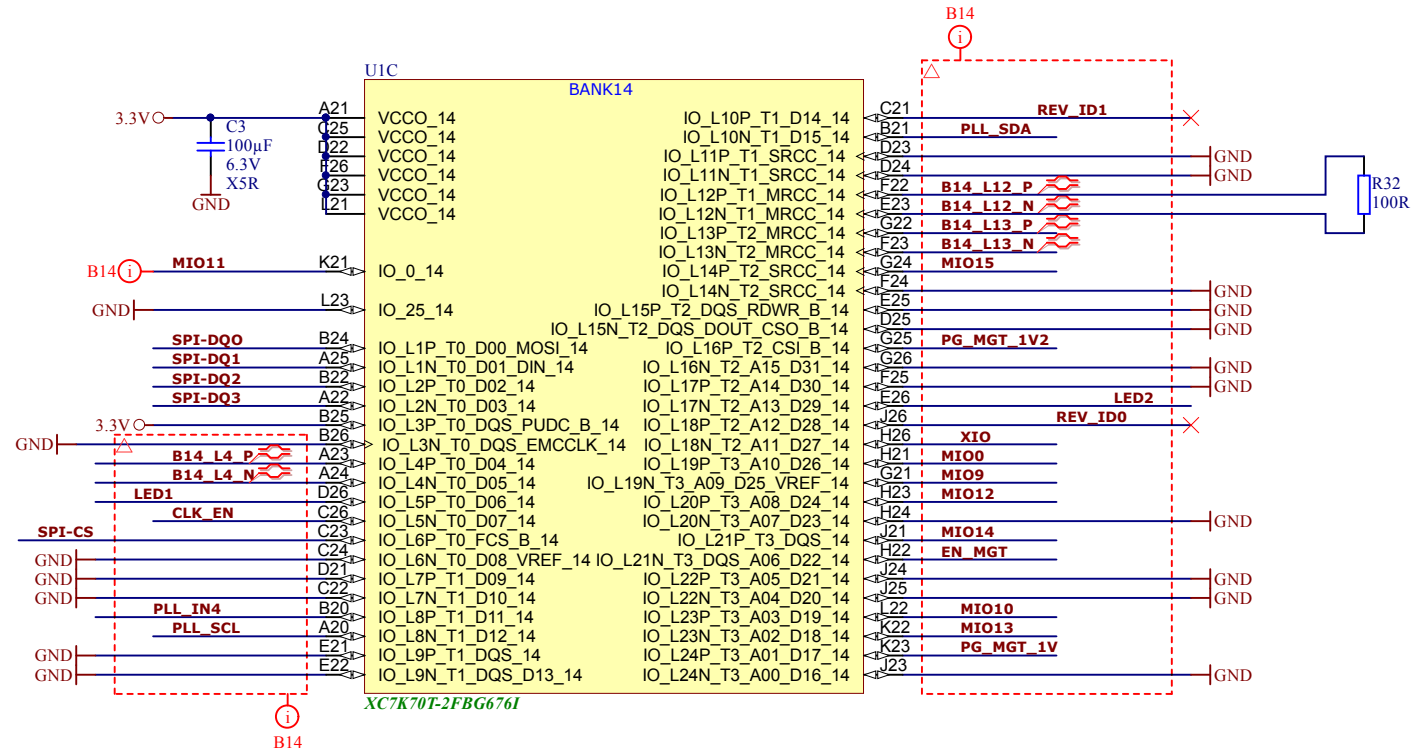

		Title: TE0741	
		A4	Number: TE0741 TE0741-070-2IF
Date: 2013-11-06		Copyright: 2013 Trenz Electronic GmbH	
Page 5 of 15		Page 5 of 15	
Filename: B14.SchDoc		Page 5 of 15	

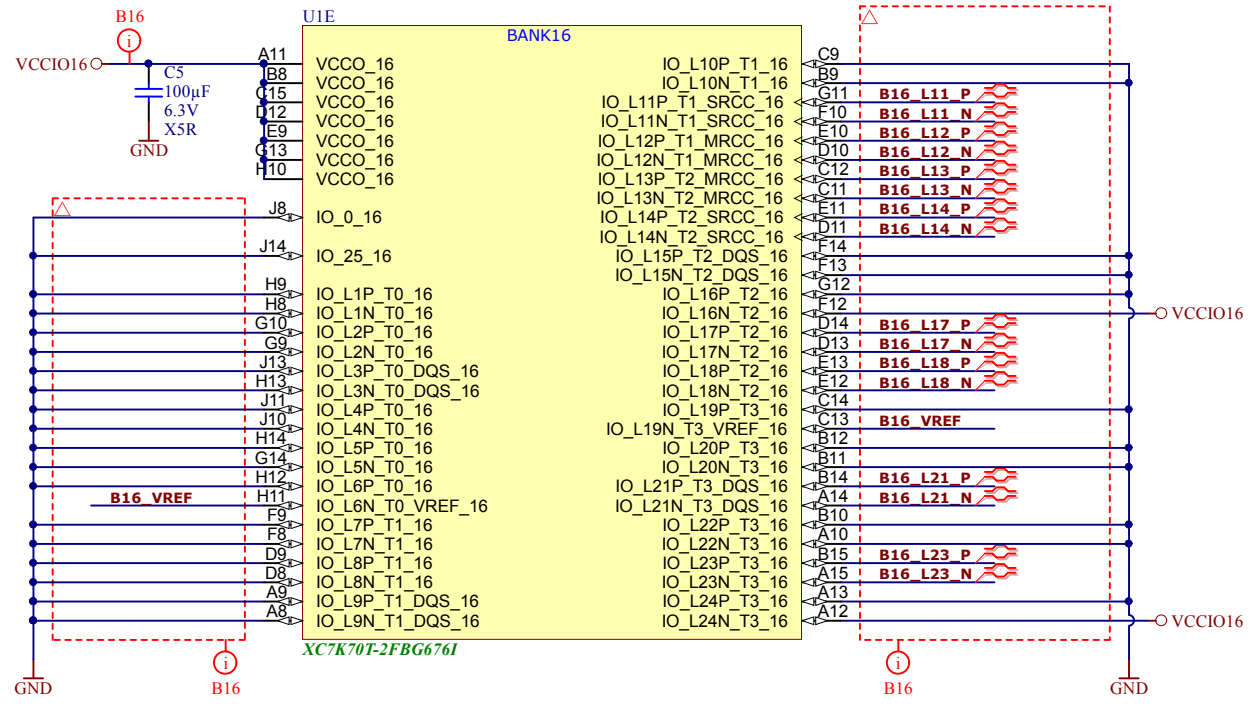

		Title: TE0741	
		A4	Number: TE0741 TE0741-070-2IF
Date: 2013-11-06		Copyright: 2013 Trenz Electronic GmbH	
Page 6		of 15	
Filename: B16.SchDoc			

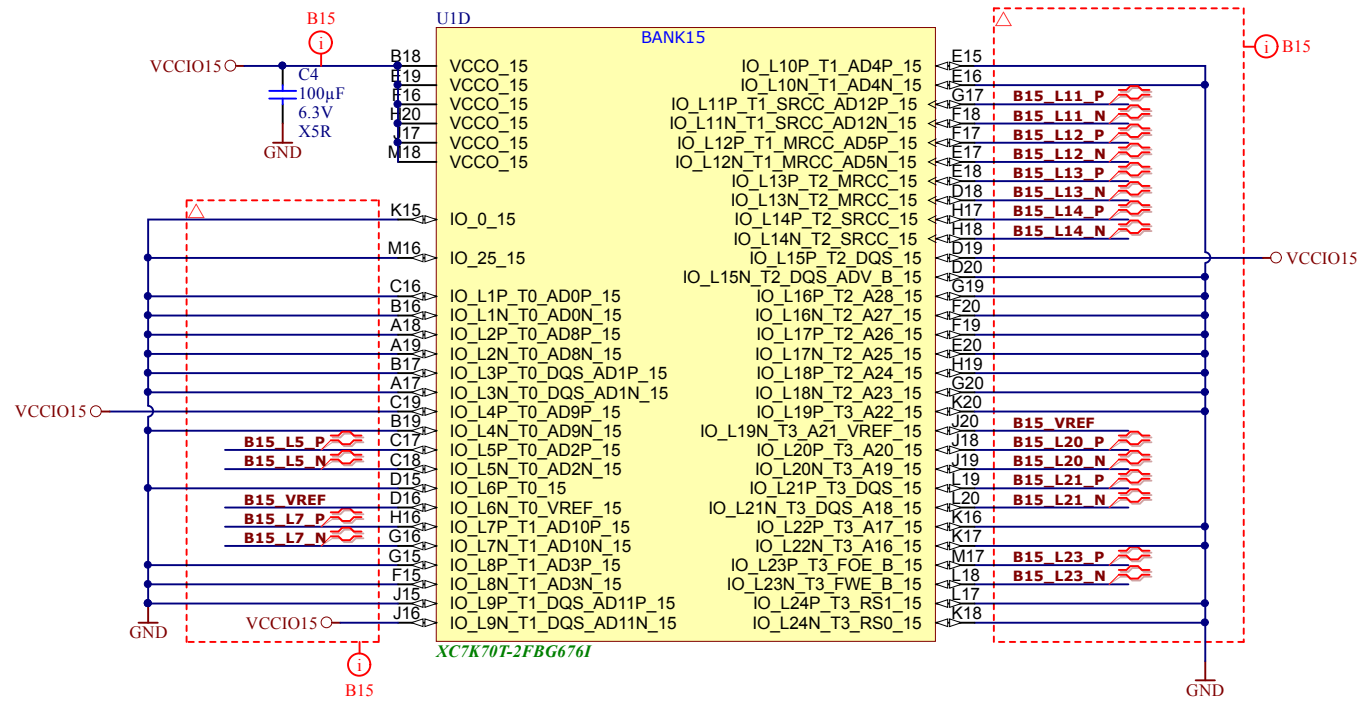

Title: TE0741		
A4	Number: TE0741 TE0741-070-2IF	Rev. 02
Date: 2013-11-06	Copyright: 2013 Trenz Electronic GmbH	Page 7 of 15
Filename: B15.SchDoc		

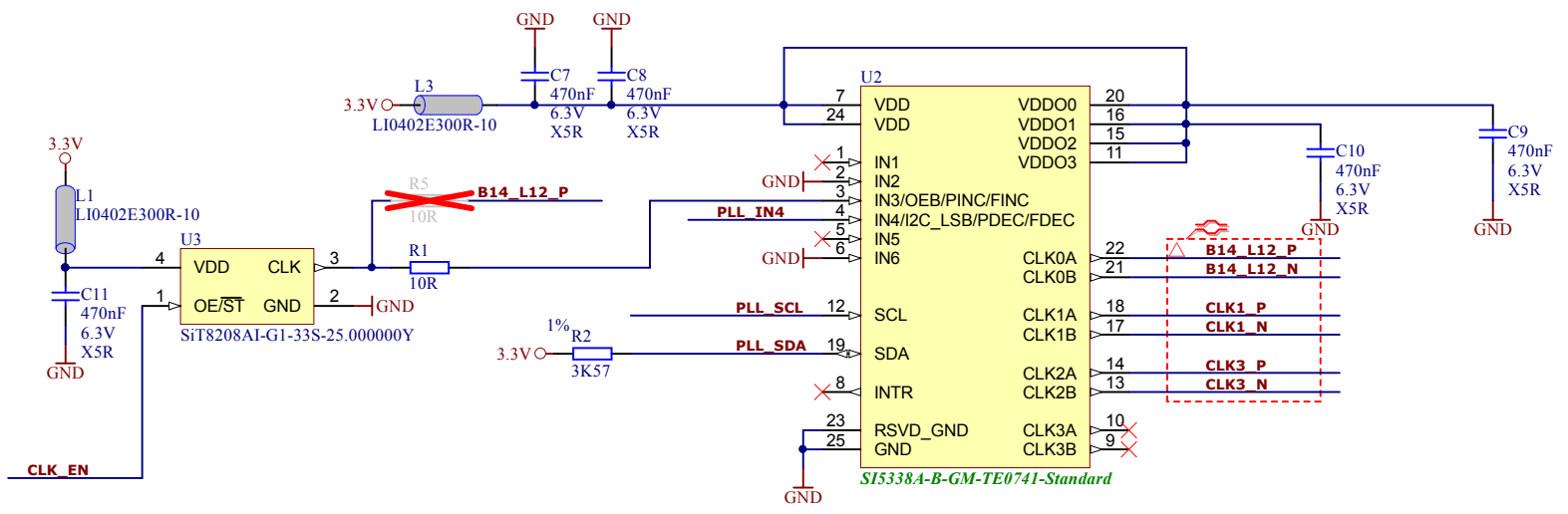

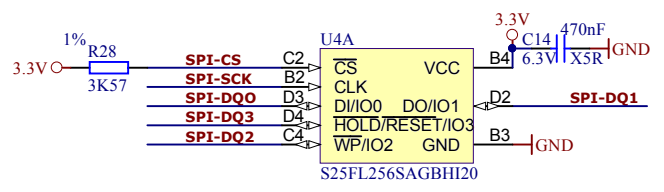
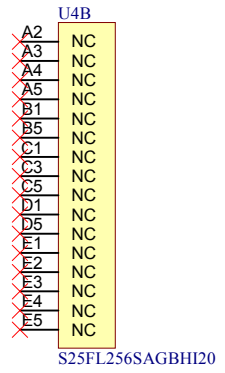
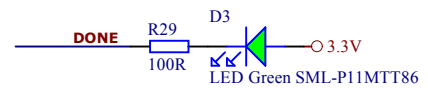
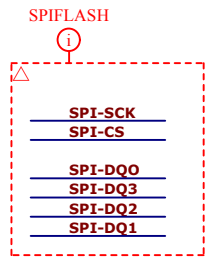
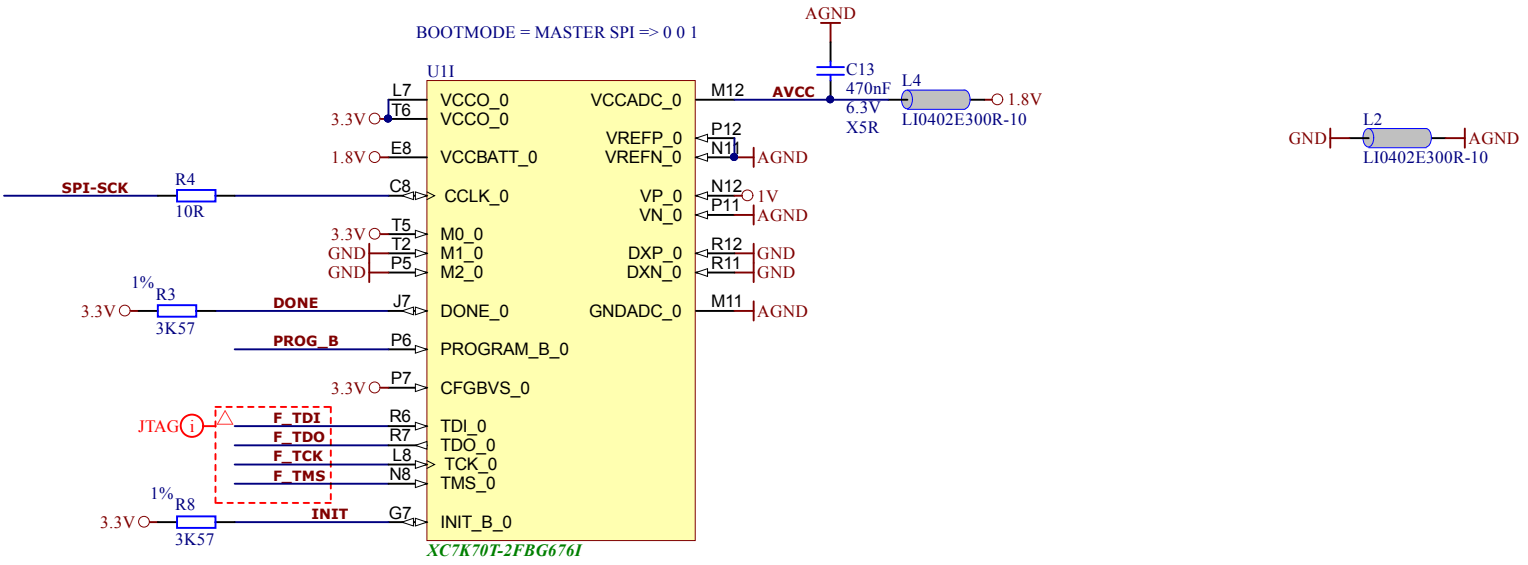

		Title: TE0741	
		A4	Number: TE0741 TE0741-070-2IF
Date: 2013-11-06		Copyright: 2013 Trenz Electronic GmbH	
Filename: Clock.SchDoc		Page 9 of 15	

BOOTMODE = MASTER SPI => 0 0 1

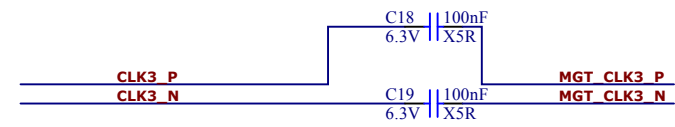
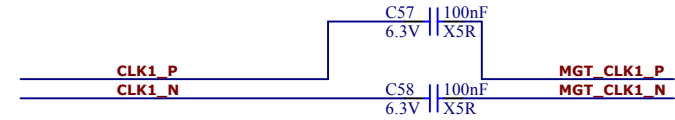
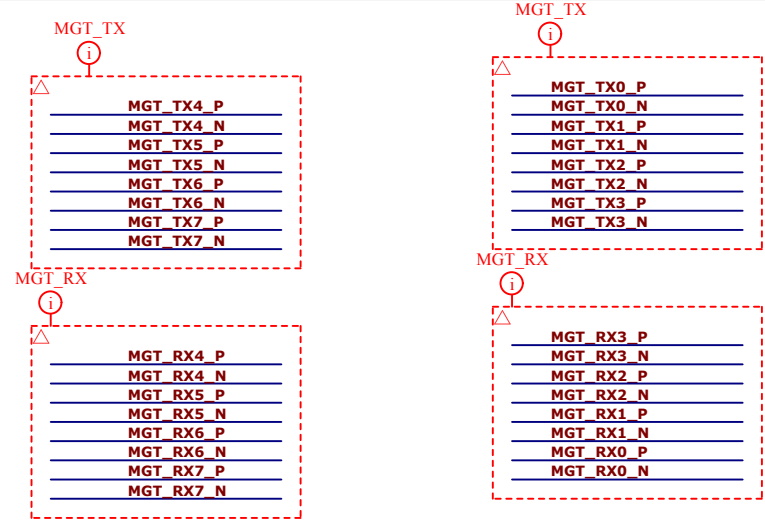
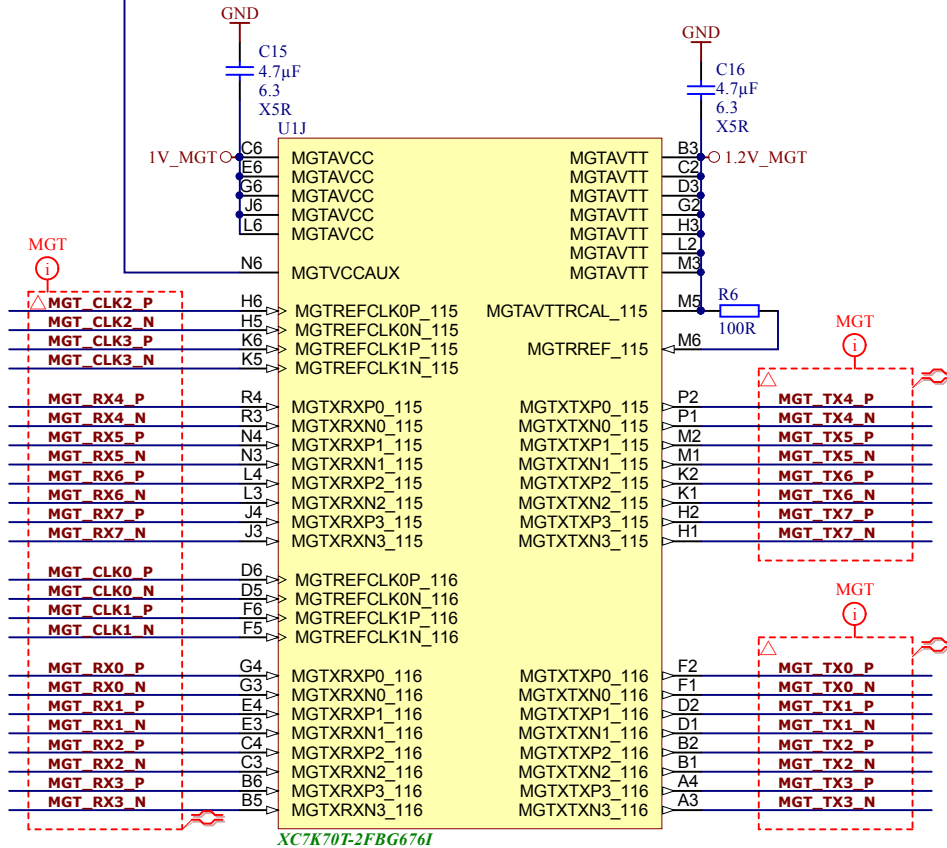
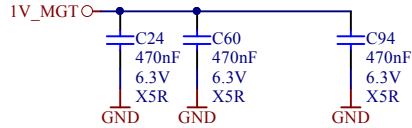
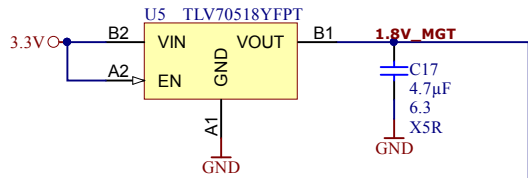

Title: TE0741		
A4	Number: TE0741 TE0741-070-2IF	Rev. 02
Date: 2013-11-06	Copyright: 2013 Trenz Electronic GmbH	Page 10 of 15
Filename: FPGA-CFG.SchDoc		

Title: TE0741		
A4	Number: TE0741 TE0741-070-2IF	Rev. 02
Date: 2013-11-06	Copyright: 2013 Trenz Electronic GmbH	Page 11 of 15
Filename: FPGA-MGT.SchDoc		

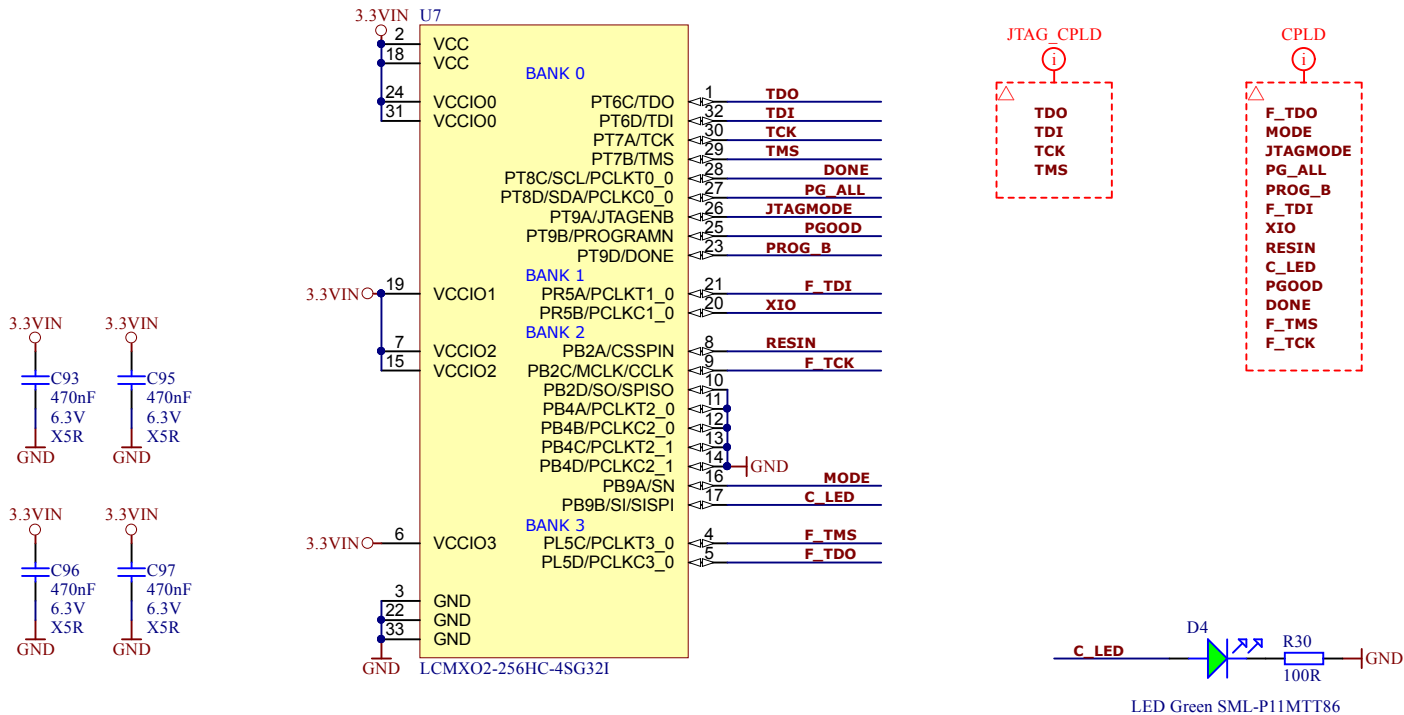

		Title: TE0741	
		A4	Number: TE0741 TE0741-070-2IF
Date: 2013-11-06		Copyright: 2013 Trenz Electronic GmbH	
Page 12 of 15		Page 12 of 15	
Filename: FPGA-MISC.SchDoc			

1

2

3

4

A

A

B

B

C

C

D

D

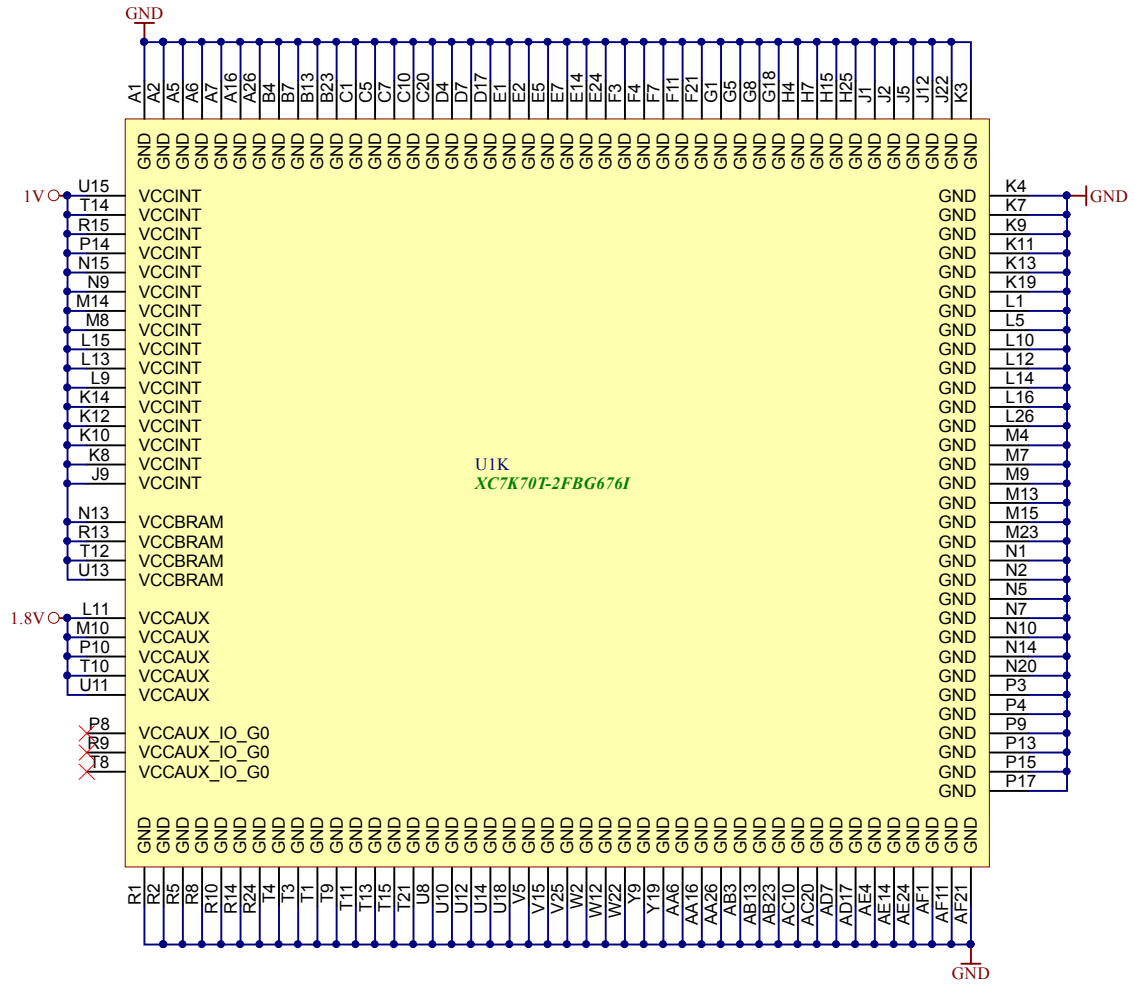
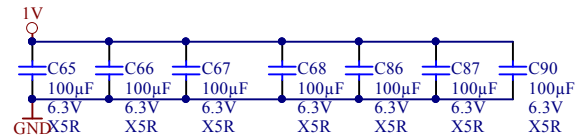
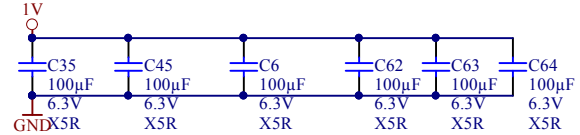
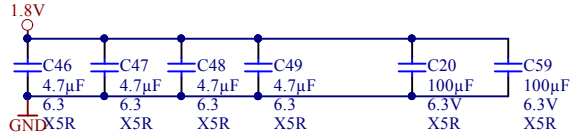
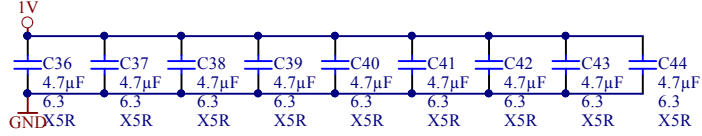
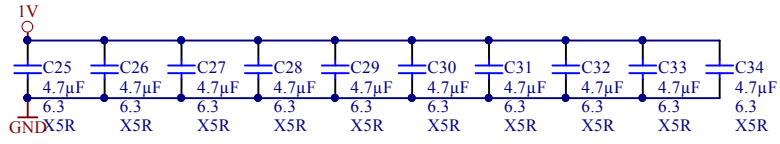

		Title: TE0741	
		A4	Number: TE0741 TE0741-070-2IF
Date: 2013-11-06		Copyright: 2013 Trenz Electronic GmbH	
Page 13 of 15		Page 13 of 15	
Filename: FPGA-PWR.SchDoc			

1

2

3

4

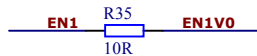
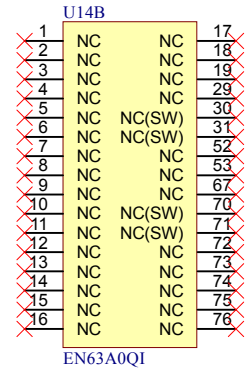
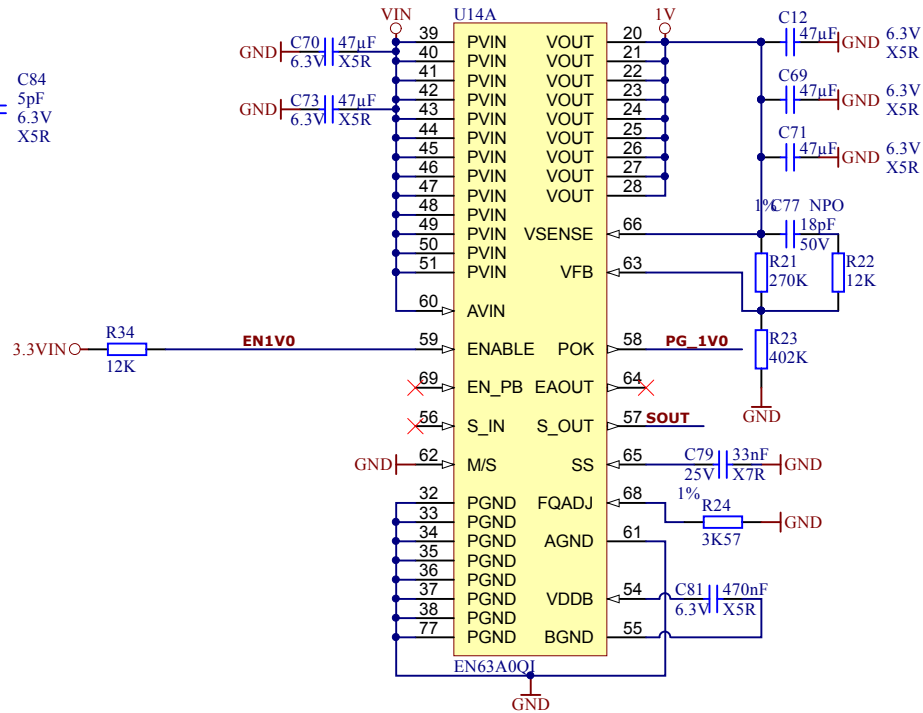
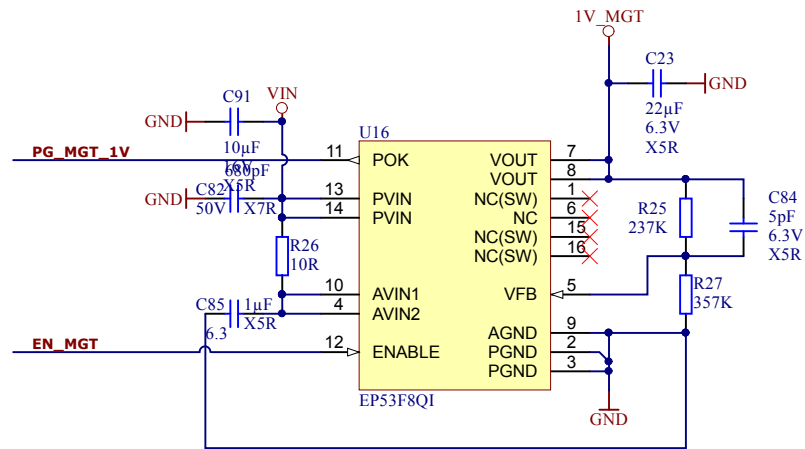

Not mount if baseboard EN1 circuit cause problems



Title: TE0741		
A4	Number: TE0741 TE0741-070-2IF	Rev. 02
Date: 2013-11-06	Copyright: 2013 Trenz Electronic GmbH	Page 14 of 15
Filename: PWR1.SchDoc		

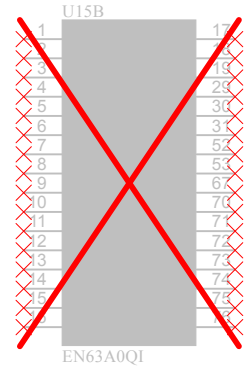
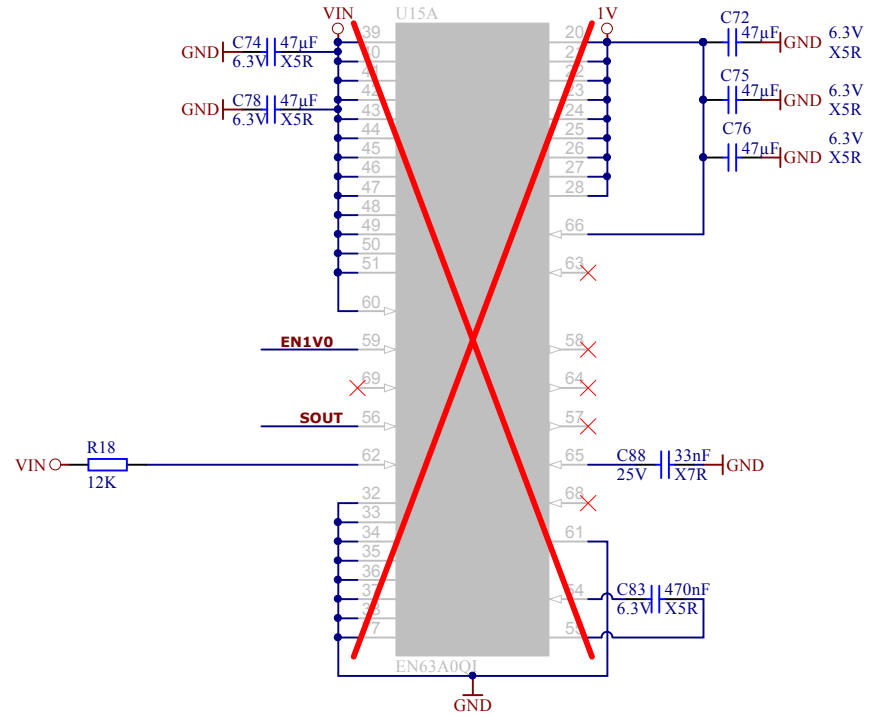
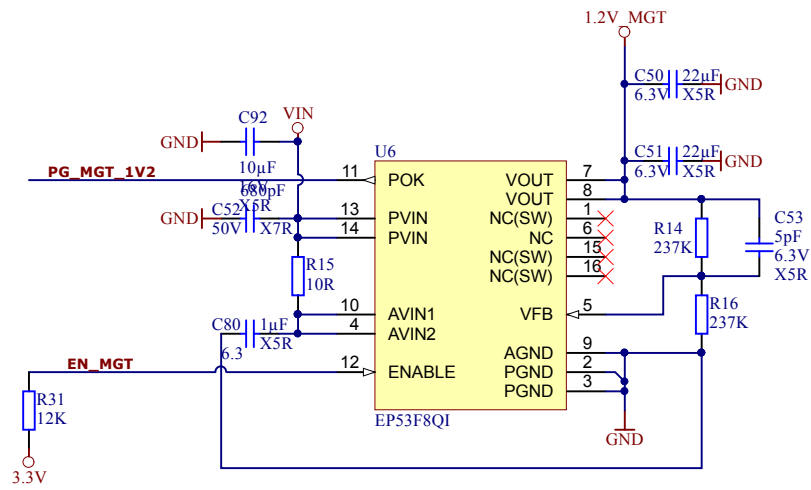

	Title: TE0741		
	A4	Number: TE0741 TE0741-070-2IF	Rev. 02
	Date: 2013-11-06	Copyright: 2013 Trenz Electronic GmbH	Page 15 of 15
	Filename: PWR2.SchDoc		