

QT-Brightek Chip LED Series

SMD 1205 LED

Part No.: QBLP655R-IW-2897

2897: High Brightness Version

Table of Contents:

Introduction	3
Electrical / Optical Characteristic (Ta=25 °C)	4
Absolute Maximum Rating	4
Chromaticity Coordinates for White	5
Characteristic Curves.....	6
Solder Profile & Footprint.....	7
Packing	8
Labeling	9
Ordering Information.....	9
Revision History	10
Disclaimer	10

Introduction

Feature:

- Package in tape and reel
- Ultra bright 1205 package
- InGaN technology for IW
- Viewing angle: 140 deg typ.
- Reverse Mountable

Description:

These ultra-bright 655R LEDs have a height profile of 1.10mm. With a combination of high brightness output and small footprint, these LEDs are ideal for keypad backlighting and status indication.

Application:

- Status indication
- Back lighting application

Certification & Compliance:

- TS16949
- ISO9001
- RoHS Compliant



Dimension:

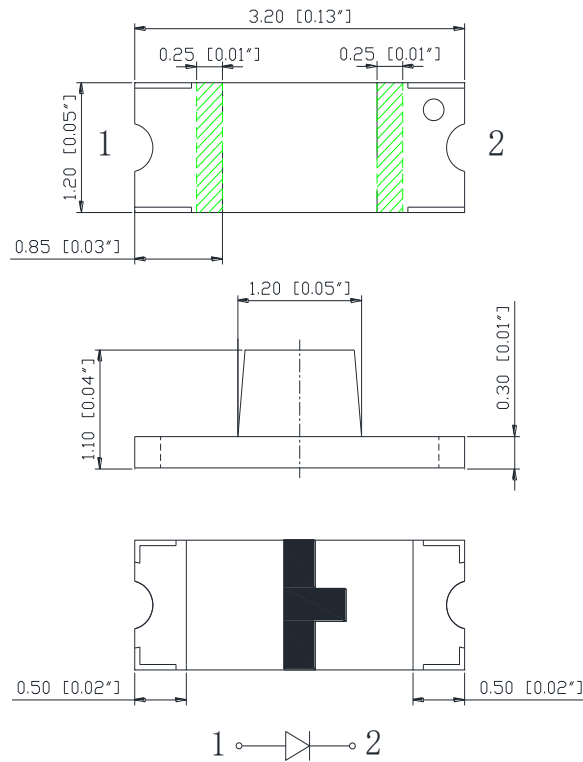

Units: mm / tolerance = +/-0.1mm

Electrical / Optical Characteristic (Ta=25 °C)

Product	Color	I _F (mA)	V _F (V)		λ _D (nm)			I _V (mcd)	
			Typ.	Max.	Min.	Typ.	Max.	Min.	Typ.
QBLP655R-IW-2897	White	20	3.1	3.7	-	X=0.31 Y=0.31	-	226	370

Absolute Maximum Rating

Material	P _d (mW)	I _F (mA)	I _{FP} (mA)*	V _R (V)	T _{OP} (°C)	T _{ST} (°C)	T _{SOL} (°C)**
InGaN (IW)	120	30	125	5	-40 ~ +85	-40 ~ +100	260

*Duty 1/8 @ 1kHz

**IR Reflow for no more than 10 sec @ 260 °C

Forward Voltage V_F for InGaN @ I_F=20mA

Bin	Min.	Max.	Unit
f	2.8	3.1	V
g	3.1	3.4	
h	3.4	3.7	

Luminous Intensity I_V @ I_F=20mA

Bin	Min.	Max.	Unit
S2	226	285	mcd
T	285	360	
U	360	450	
V1	450	500	
W	500	630	

Note:

Tolerance of measurement of forward voltage: ±0.1V

Tolerance of measurement of luminous intensity: ±15%

Chromaticity Coordinates for White

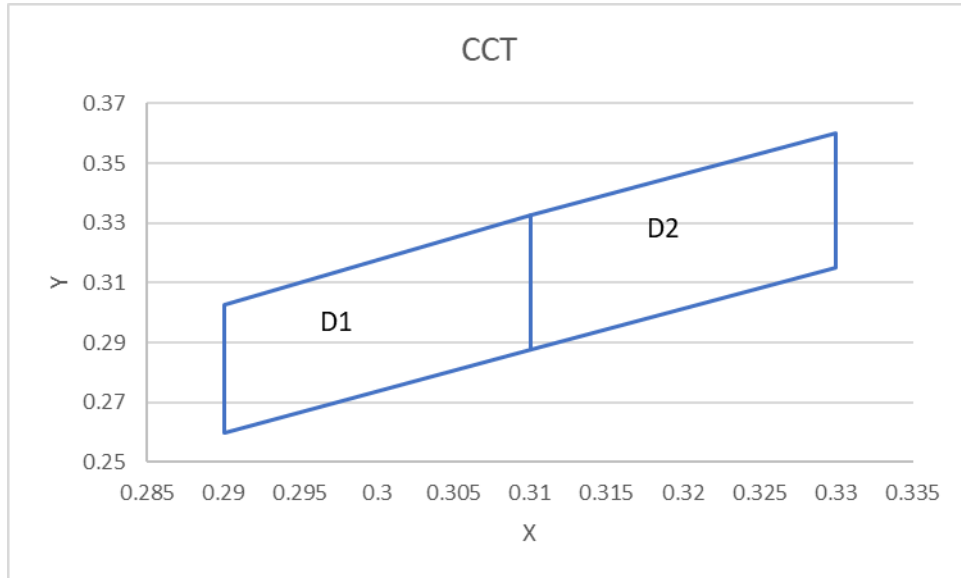

D1		D2	
0.29	0.26	0.31	0.2875
0.29	0.3025	0.31	0.3325
0.31	0.3325	0.33	0.36
0.31	0.2875	0.33	0.315
0.29	0.26	0.31	0.2875

Note:
Tolerance of measurement of color coordinates: ± 0.01

Characteristic Curves

InGaN (IW)

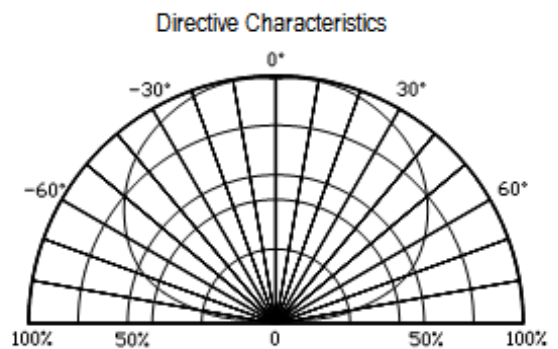
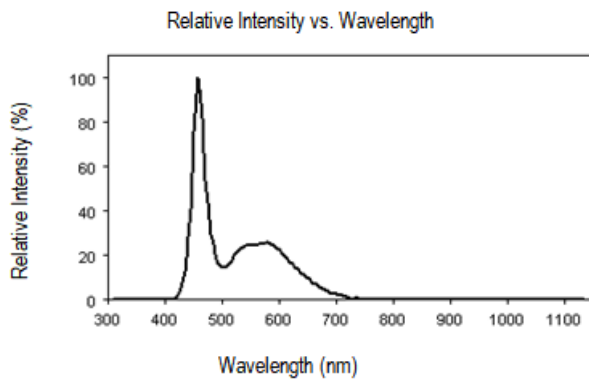
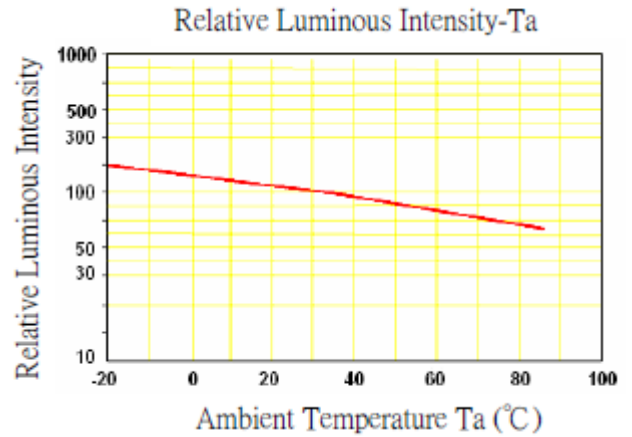
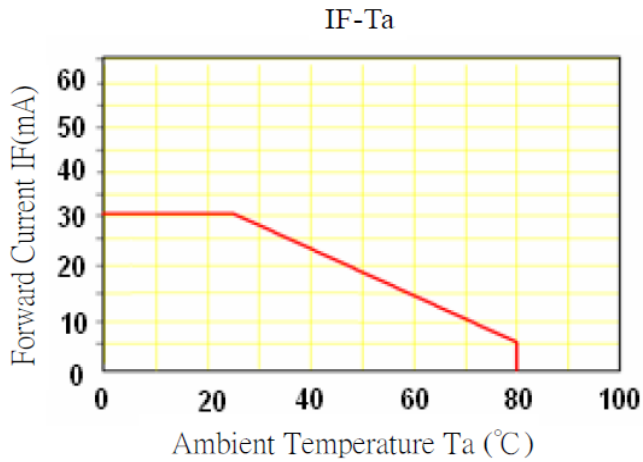
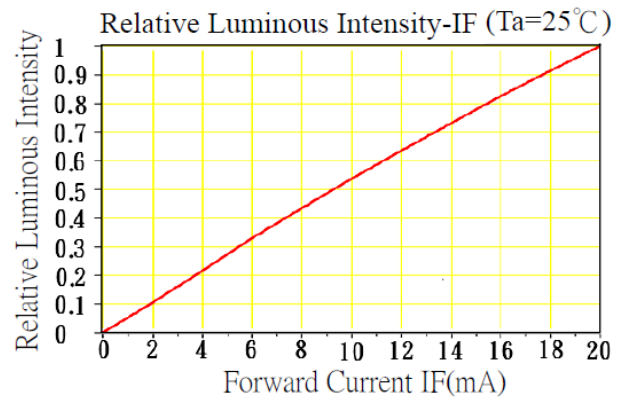
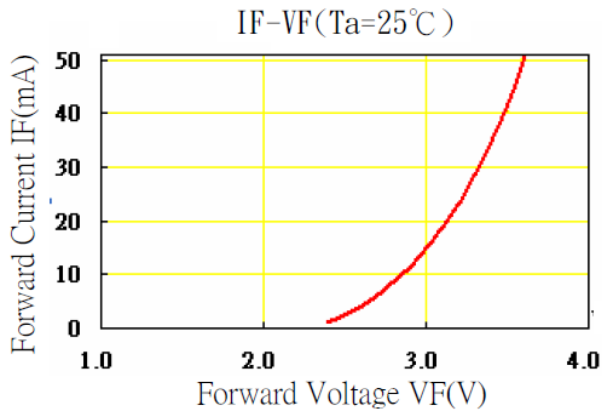

Solder Profile & Footprint

-The recommended reflow soldering profile is as follows (temperatures indicated are as measured on the surface of the LED resin):

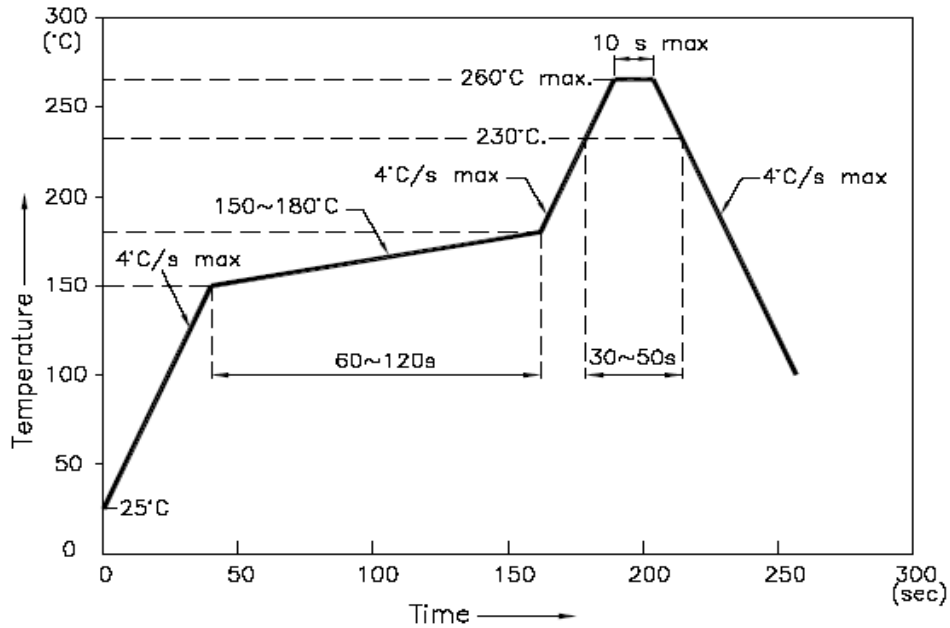

Recommended Pad Layout

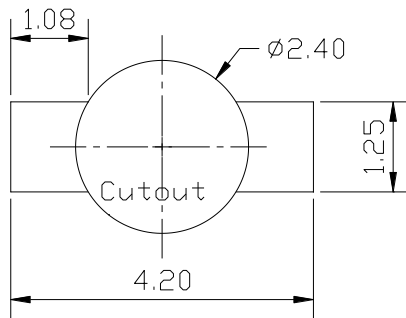

Units: mm

tolerance: +/- 0.1mm

Product: QBLP655R-IW-2897	Date: August 08, 2018	Page 7 of 10
	Version# 1.0	

Packing

Reel Dimension:

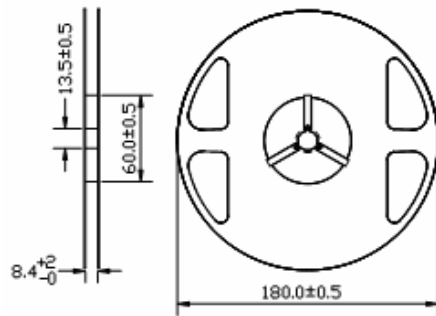

Unit: mm

Tape Dimension:

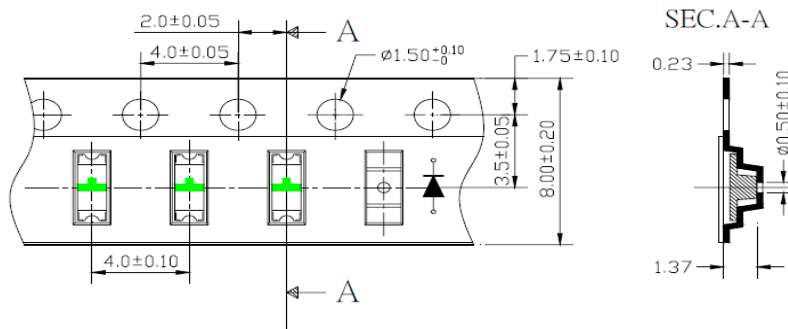

Unit: mm

Arrangement of Tape:

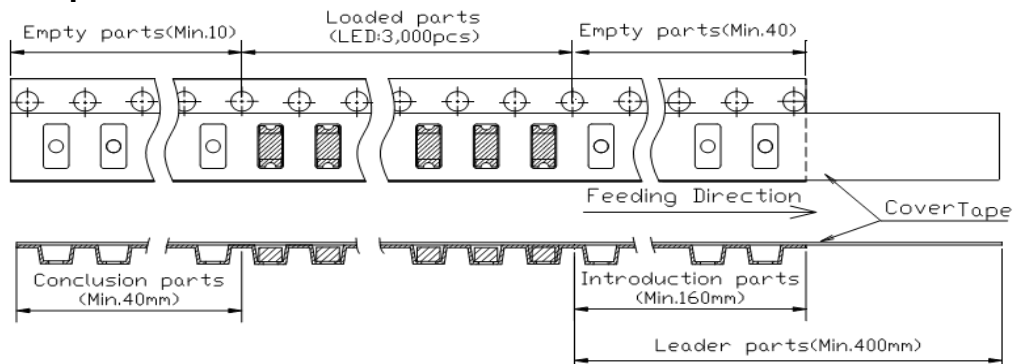

Packaging Specifications:

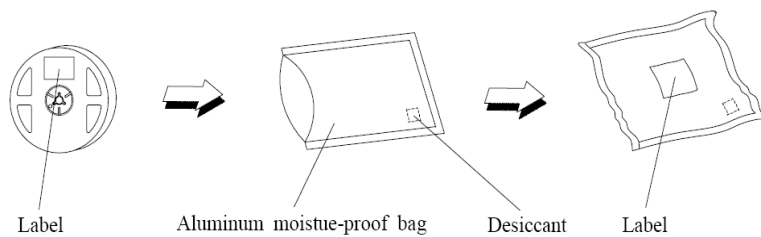

Product: QBLP655R-IW-2897	Date: August 08, 2018	Page 8 of 10
	Version# 1.0	

Labeling

Part No: _____

Customer P/N: _____

Item: _____

Q'ty: _____

Vf: _____

Iv: _____

Wl: _____

Date: _____

Made in China**Ordering Information**

Part #	Orderable Part #	Spec Range	Quantity per reel
QBLP655R-IW-2897	QBLP655R-IW-2897	Iv=370mcd typ. @ 20mA / CCT Coordinate: (X=0.31, Y=0.31) typ.	3,000 units

Product: QBLP655R-IW-2897	Date: August 08, 2018	Page 9 of 10
	Version# 1.0	

Revision History

Description:	Revision #	Revision Date
New Release of QBLP655R-IW-2897	V1.0	08/08/2018

Disclaimer

QT-BRIGHTTEK reserves the right to make changes without further notice to any products herein to improve reliability, function or design. QT-BRIGHTTEK does not assume any liability arising out of the application or use of any product or circuit described herein; neither does it convey any license under its patent rights, nor the rights of others.

Life Support Policy

QT-BRIGHTTEK's products are not authorized for use as critical components in life support devices or systems without the express written approval of QT-BRIGHTTEK. As used herein:

1. Life support devices or systems are devices or systems which, (a) are intended for surgical implant into the body, or (b) support or sustain life, and (c) whose failure to perform when properly used in accordance with instructions for use provided in the labeling, can be reasonably expected to result in a significant injury of the user.
2. A critical component in any component of a life support device or system whose failure to perform can be reasonably expected to cause the failure of the life support device or system, or to affect its safety or effectiveness.

Product: QBLP655R-IW-2897	Date: August 08, 2018	Page 10 of 10
	Version# 1.0	