

## ANT-2.4-WRT-MON-ccc

### 2.4 GHz WiFi External Panel-Mount Antenna

The ANT-2.4-WRT-MON is a low-profile, panel-mount monopole antenna designed for 2.4 GHz WiFi/WLAN and ISM applications including Bluetooth® and ZigBee®.

The ANT-2.4-WRT-MON antenna's compact size allows it to be mounted securely in enclosures requiring added security. The ANT-2.4-WRT-MON antenna's compact profile and rugged dome reduces the likelihood of accidental damage versus a whip antenna.

The antenna connects to the radio via SMA plug (male pin), RP-SMA plug (female socket) MHF1/ U.FL-type plug (female socket) or MHF4 plug (female socket) on 216 mm (8.5 in.) coaxial cable.



#### Features

- Performance at 2.4 GHz to 2.5 GHz
  - VSWR:  $\leq 1.7$
  - Peak Gain: 2.7 dBi
  - Efficiency: 82%
- Low-profile
  - Height: 27.0 mm (1.06 in)
- Mounts permanently with pressure sensitive adhesive ring and provided hex nut

#### Applications

- Single-band WiFi/WLAN
  - 802.11b/g
- 2.4 GHz ISM applications
  - Bluetooth®
  - ZigBee®
  - IEEE 802.15.4
- Internet of Things (IoT) devices
- Smart Home networking
  - Sensing and remote monitoring
  - Security

#### Ordering Information

Part Number	Description
<b>ANT-2.4-WRT-MON-RPS</b>	Antenna with 216 mm (8.5 in) of RG-174 coaxial cable with an RP-SMA plug (female socket) connector
<b>ANT-2.4-WRT-MON-SMA</b>	Antenna with 216 mm (8.5 in) of RG-174 coaxial cable with an SMA plug (male pin) connector
<b>ANT-2.4-WRT-MON-UFL</b>	Antenna with 216 mm (8.5 in) of 1.32 mm coaxial cable with an MHF1/U.FL-type plug (female socket) connector
<b>ANT-2.4-WRT-MON-MHF4</b>	Antenna with 216 mm (8.5 in) of 1.13 mm coaxial cable with an MHF4-type plug (female socket) connector

Available from Linx Technologies and select distributors and representatives.

Table 1. Electrical Specifications

ANT-2.4-WRT-MON	2.4 GHz		
Frequency Range	2.4 GHz to 2.5 GHz		
VSWR (max)	1.7		
Peak Gain (dBi)	2.7		
Average Gain (dBi)	-1.0		
Efficiency (%)	82		
Polarization	Linear	Radiation	Omnidirectional
Impedance	50 Ω	Max Power	5 W
Wavelength	1/4-wave	Electrical Type	Monopole

Electrical specifications and plots measured with a 102 mm x 102 mm (4.0 in x 4.0 in) reference ground plane.

Table 2. Mechanical Specifications

Parameter	Value
Operating Temp. Range	-40 °C to +85 °C
Weight	-MHF4 = 13.8 g (0.49 oz), -RPS & -SMA = 18.9 g (0.66 oz), -UFL = 13.9 g (0.49 oz)
Connection	MHF4 plug (female socket) on 1.13 mm coaxial cable RP-SMA plug (female socket) on RG-174 coaxial cable SMA plug (male pin) on RG-174 coaxial cable MHF1/U.FL-type plug (female socket) on 1.32 mm coaxial cable
Coaxial Cable, minimum inside bend radius	RG-174: 10.2 mm (0.40 in), 1.13 mm: 5.0 mm (0.20 in), 1.32 mm: 6.0 mm (0.24 in)
Dimensions	Height: 27.0 mm (1.06 in), Diameter: 19.0 mm (0.75 in)

## Packaging Information

The ANT-2.4-WRT-MON series antenna is individually sealed in a clear plastic bag. Individual packages are packed in a bag of 100 pcs. Distribution channels may offer alternative packaging options.

## Product Dimensions

Figure 1 provides dimensions for the ANT-2.4-WRT-MON series antenna.

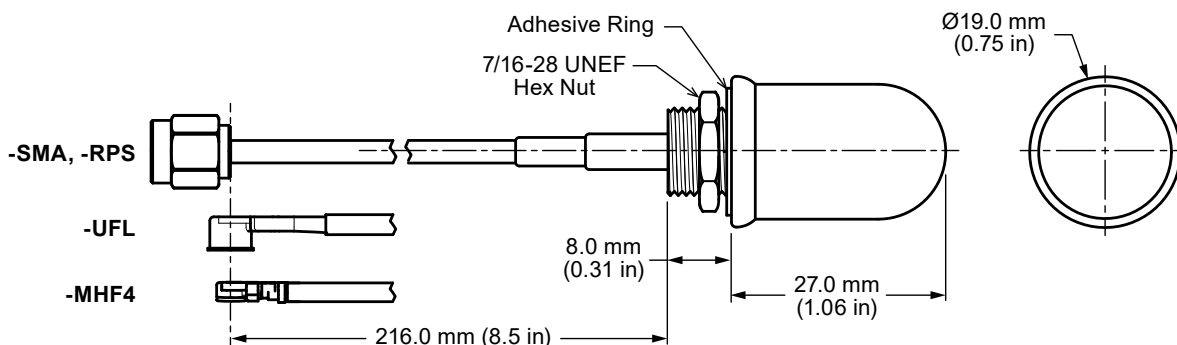

Figure 1. ANT-2.4-WRT-MON Antenna Dimensions

**Recommended Mounting**

The recommended enclosure mounting dimensions are shown in Figure 2. The ANT-2.4-WRT-MON series antenna is supplied with an integrated closed-cell pressure sensitive adhesive ring which helps seal enclosures against external elements. The adhesive ring has a protective plastic backing that must be removed prior to installation. A pull tab has been provided for easy removal of the protective backing. The antenna can be permanently mounted using the provided hex nut which should be tightened to 3.0 kgf/cm (5 in/lbs) max. The recommended maximum enclosure wall thickness is 3.18 mm (0.125 in).

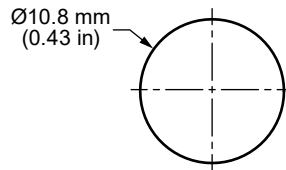

Figure 2. ANT-2.4-WRT-MON Series Antenna Recommended Enclosure Mounting Dimensions

**Ground Plane**

1/4-Wave monopole antennas require an associated ground plane counterpoise for proper operation. The size and location of the ground plane relative to the antenna will affect the overall performance of the antenna in the final design. When used in conjunction with a ground plane smaller than that used to tune the antenna, the center frequency typically will shift higher in frequency and the bandwidth will decrease. The proximity of other circuit elements and packaging near the antenna will also affect the final performance.

For further discussion and guidance on the importance of the ground plane counterpoise, please refer to Linx Application Note, AN-00501: *Understanding Antenna Specifications and Operation*.

**Antenna Orientation**

The ANT-2.4-WRT-MON antenna is characterized with the antenna at the center of a 102 mm x 102 mm ground plane as shown in Figure 3.

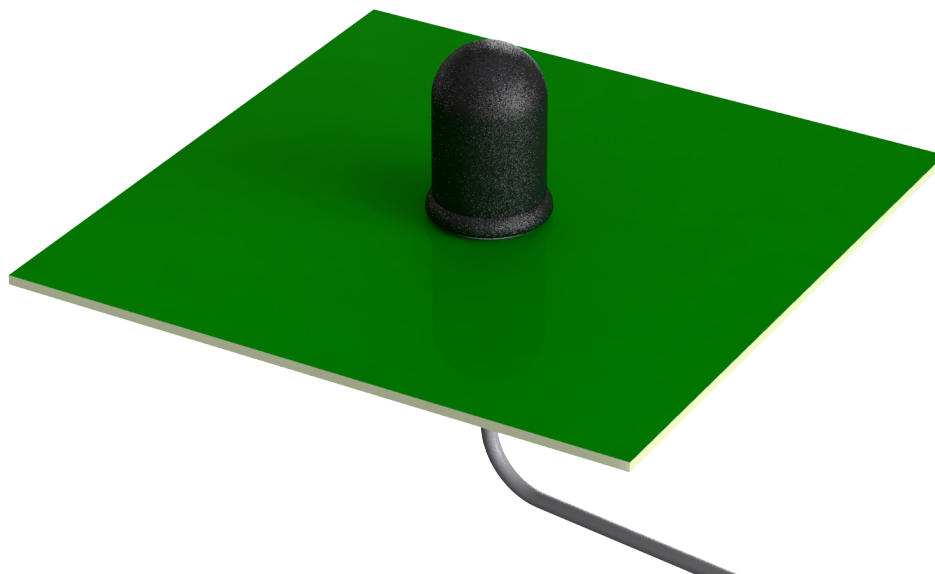

Figure 3. ANT-2.4-WRT-MON Test Orientation

### VSWR

Figure 4 provides the voltage standing wave ratio (VSWR) across the antenna bandwidth. VSWR describes the power reflected from the antenna back to the radio. A lower VSWR value indicates better antenna performance at a given frequency. Reflected power is also shown on the right-side vertical axis as a gauge of the percentage of transmitter power reflected back from the antenna.

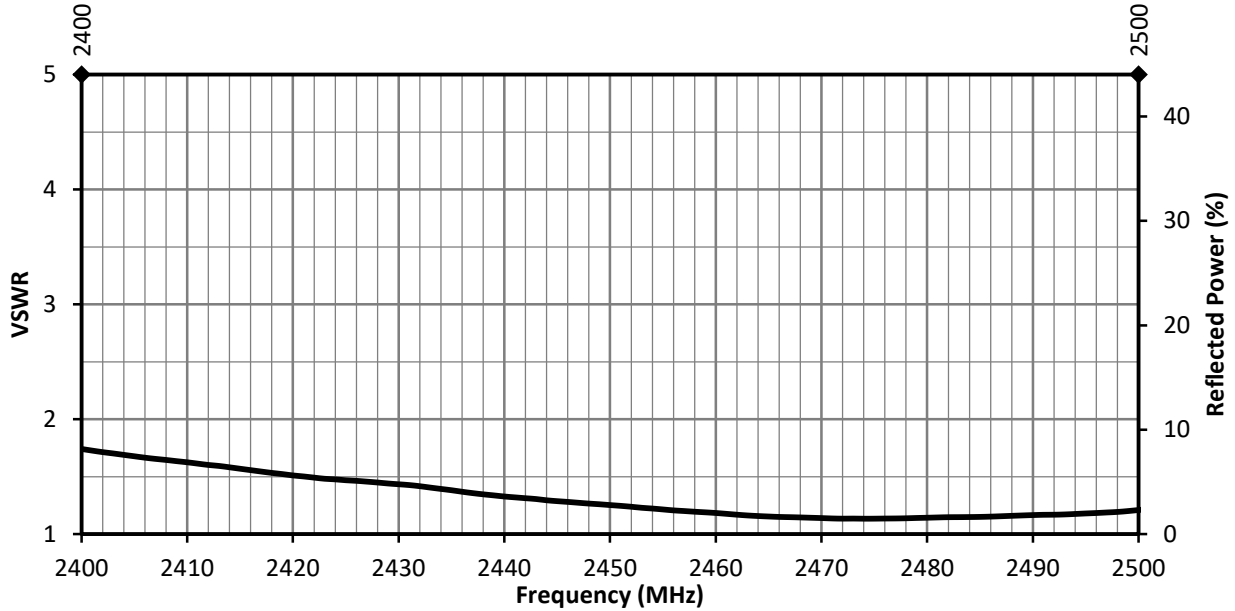

Figure 4. ANT-2.4-WRT-MON VSWR

### Return Loss

Return loss (Figure 5), represents the loss in power at the antenna due to reflected signals. Like VSWR, a lower return loss value indicates better antenna performance at a given frequency.

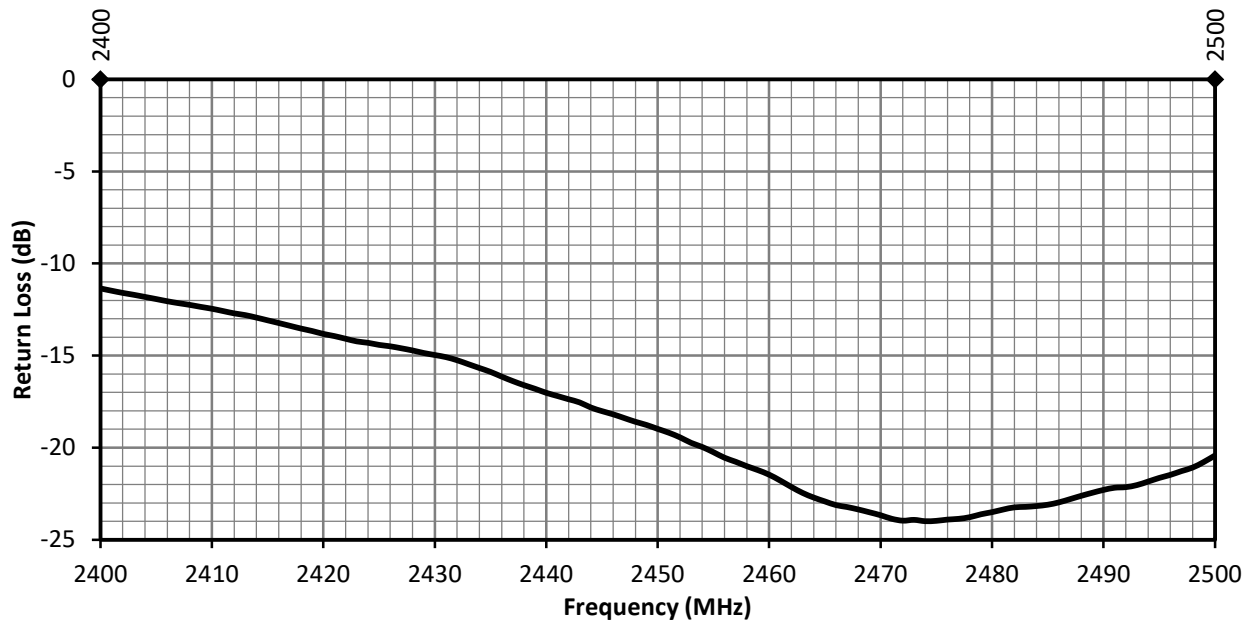

Figure 5. ANT-2.4-WRT-MON Return Loss

## Datasheet

### Peak Gain

The peak gain across the antenna bandwidth is shown in Figure 6. Peak gain represents the maximum antenna input power concentration across 3-dimensional space, and therefore peak performance at a given frequency, but does not consider any directionality in the gain pattern.

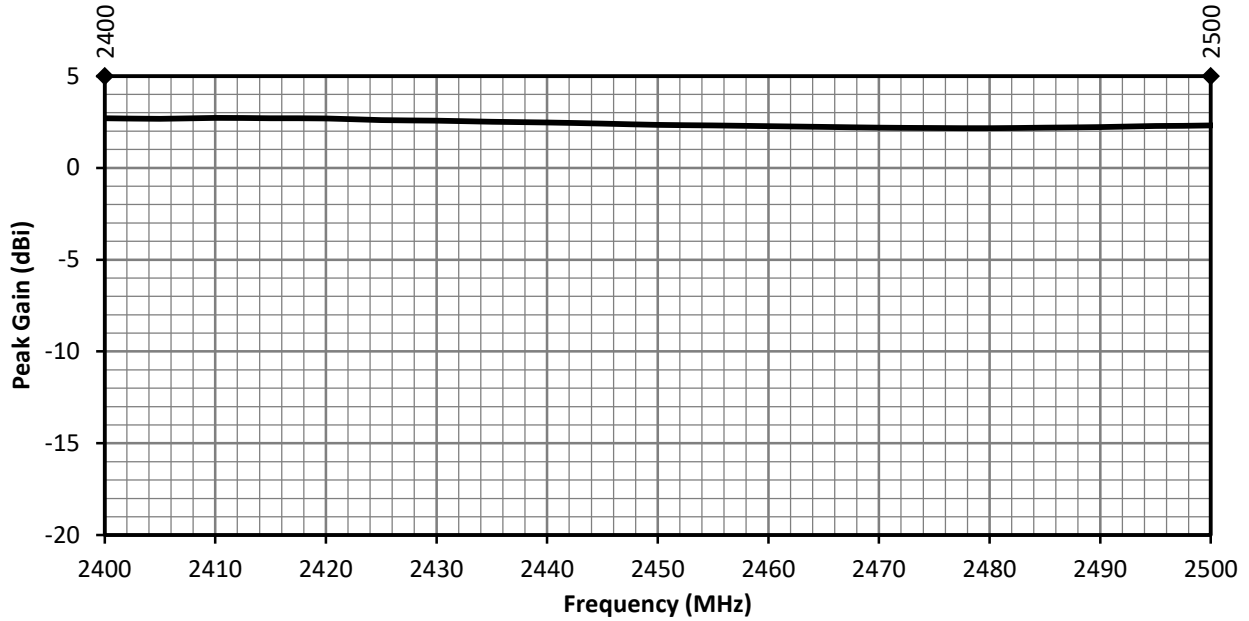

Figure 6. ANT-2.4-WRT-MON Peak Gain

### Average Gain

Average gain (Figure 7), is the average of all antenna gain in 3-dimensional space at each frequency, providing an indication of overall performance without expressing antenna directionality.

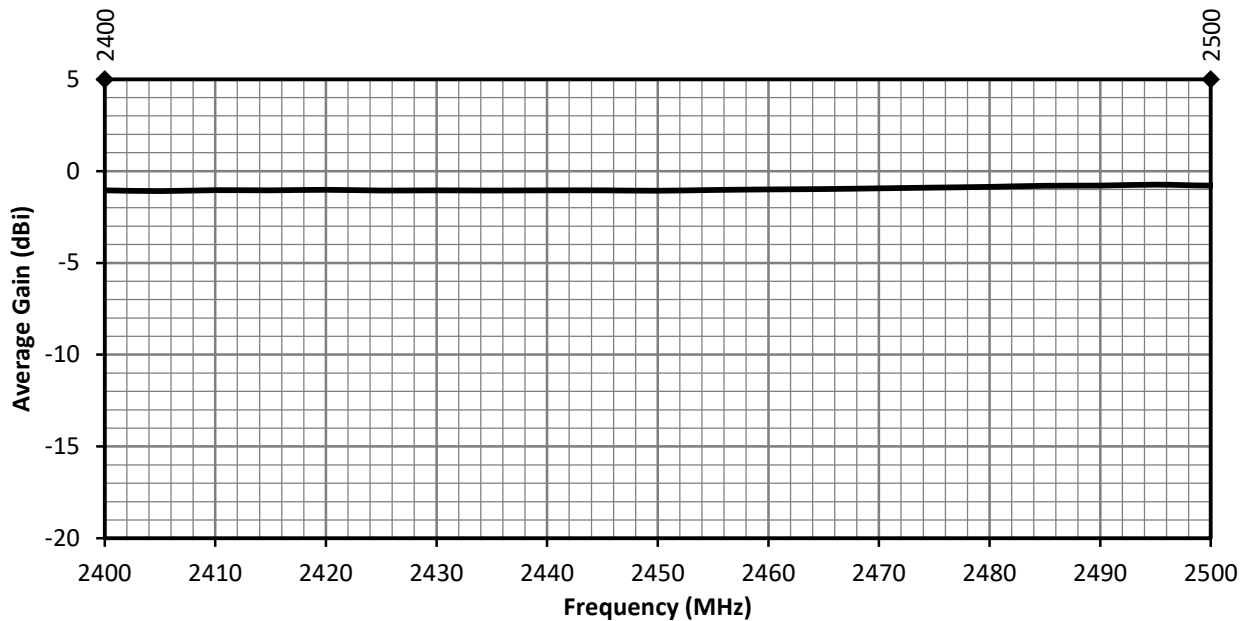

Figure 7. ANT-2.4-WRT-MON Antenna Average Gain

### Radiation Efficiency

Radiation efficiency (Figure 8), shows the ratio of power delivered to the antenna relative to the power radiated at the antenna, expressed as a percentage, where a higher percentage indicates better performance at a given frequency.

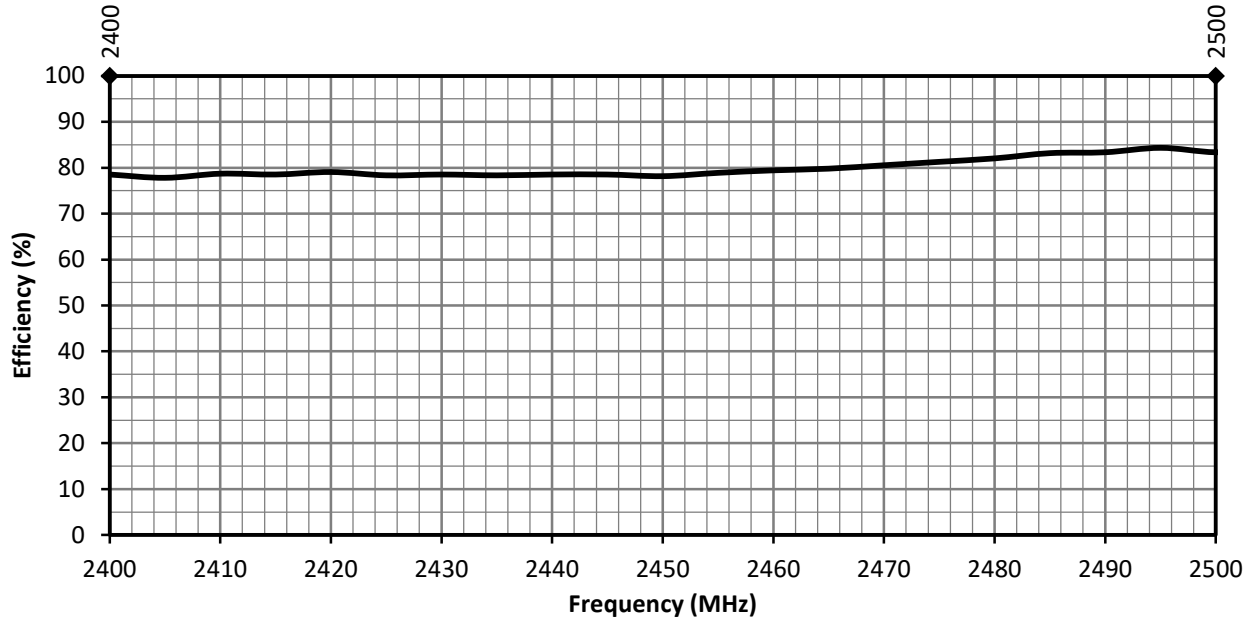
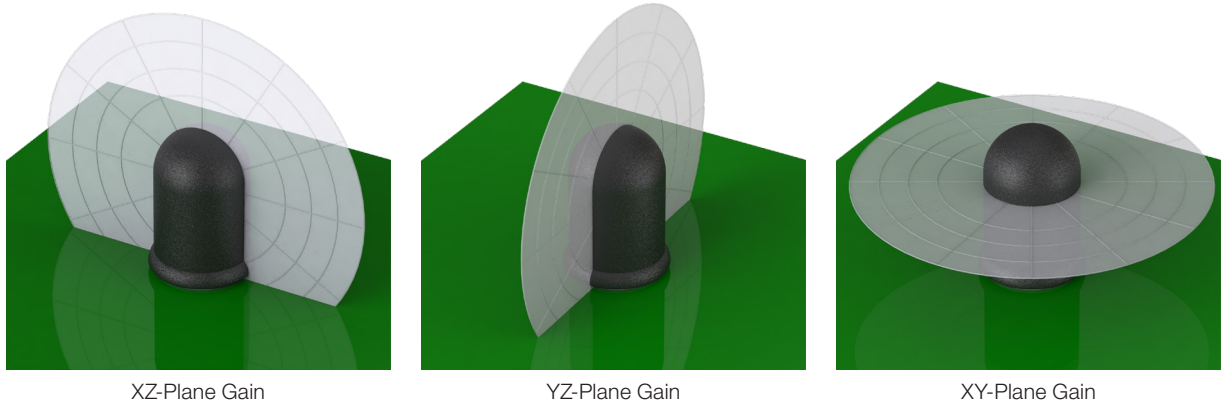

Figure 8. ANT-2.4-WRT-MON Antenna Radiation Efficiency

Datasheet

Radiation Patterns

Radiation patterns provide information about the directionality and 3-dimensional gain performance of the antenna by plotting gain at specific frequencies in three orthogonal planes. Antenna radiation patterns are shown in Figure 9 using polar plots covering 360 degrees. The antenna graphic at the top of the page provides reference to the plane of the column of plots below it. Note: when viewed with typical PDF viewing software, zooming into radiation patterns is possible to reveal fine detail.



2400 MHz to 2500 MHz (2450 MHz)

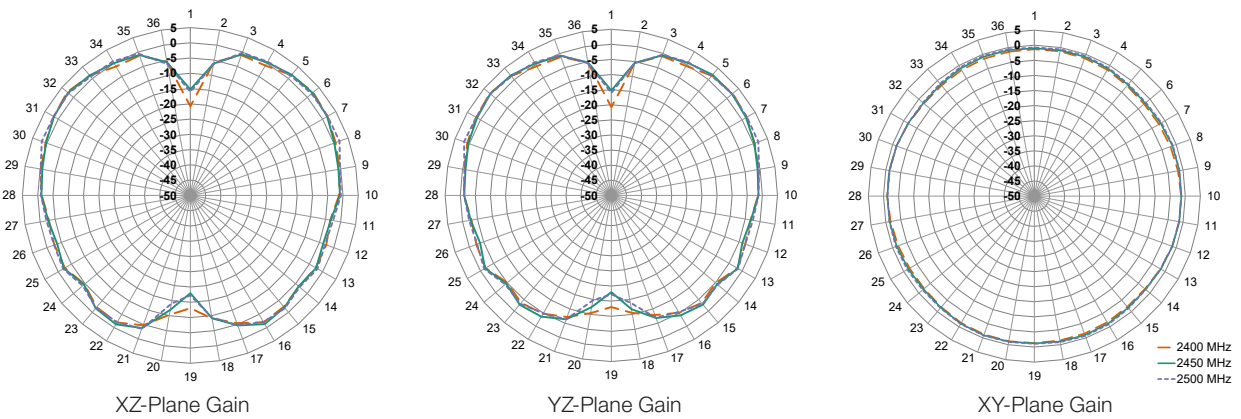

Figure 9. ANT-2.4-WRT-MON Radiation Patterns

---

**Website:** <http://linxtechnologies.com>  
**Linx Offices:** 159 Ort Lane, Merlin, OR, US 97532  
**Phone:** +1 (541) 471-6256  
**E-MAIL:** [info@linxtechnologies.com](mailto:info@linxtechnologies.com)

---

Linx Technologies reserves the right to make changes to the product(s) or information contained herein without notice. No liability is assumed as a result of their use or application. No rights under any patent accompany the sale of any such product(s) or information.

Wireless Made Simple is a registered trademark of Linx Acquisitions LLC. Other product and brand names may be trademarks or registered trademarks of their respective owners.

Copyright © 2022 Linx Technologies

All Rights Reserved

Doc# DS22013-201ANT Replaces (Dated release 2017)

