

SM35N473K202A

KPS SM SMD Indust COG HV, Ceramic, 0.047 uF, 10%, 2000 VDC, COG, SMD, Fixed, High Volt, Low ESR, Leaded, Industrial, SM35

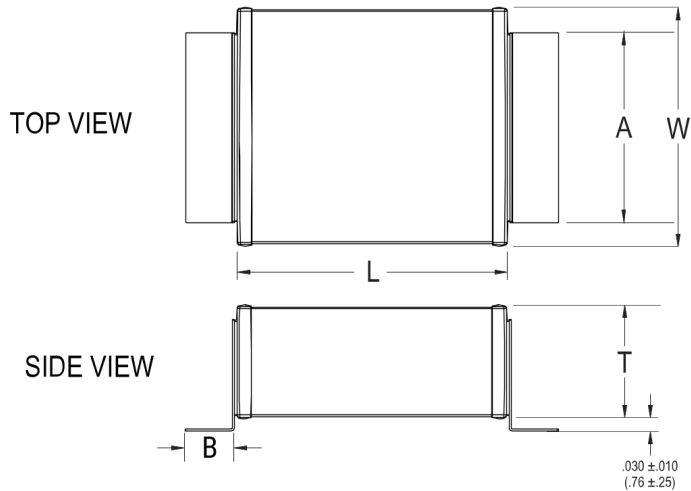

Click [here](#) for the 3D model.

Dimensions	
Chip Size	SM35
L	27.94mm +/-0.762mm
W	12.7mm +/-0.762mm
T	5.588mm MAX
A	10.2mm MAX
B	2.54mm +/-0.508mm

Packaging Specifications	
Packaging	Tray
Packaging Quantity	10

General Information	
Series	KPS SM SMD Indust COG HV
Style	SMD Chip
Description	SMD, Fixed, High Volt, Low ESR, Leaded, Industrial
Features	High Voltage, Low ESR, Industrial Grade
RoHS	With Exemptions
REACH	SVHC (Pb - CAS 7439-92-1)
Termination	Silver
Marking	No
AEC-Q200	No
Shelf Life	78 Weeks
MSL	1

Specifications	
Capacitance	0.047 uF
Capacitance Tolerance	10%
Voltage DC	2000 VDC
Dielectric Withstanding Voltage	2400 VDC
Temperature Range	-55/+125°C
Temperature Coefficient	COG
Dissipation Factor	0.15%
Insulation Resistance	21.3 GOhms

Statements of suitability for certain applications are based on our knowledge of typical operating conditions for such applications, but are not intended to constitute - and we specifically disclaim - any warranty concerning suitability for a specific customer application or use. This information is intended for use only by customers who have the requisite experience and capability to determine the correct products for their application. Any technical advice inferred from this information or otherwise provided by us with reference to the use of our products is given gratis, and we assume no obligation or liability for the advice given or results obtained.