

PAGE 1/4	ISSUE 04-01-17E	SERIES SMP	PART NUMBER R222423320
----------	------------------------	-------------------	-------------------------------

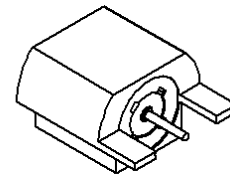

All dimensions are in mm.

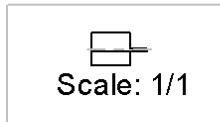
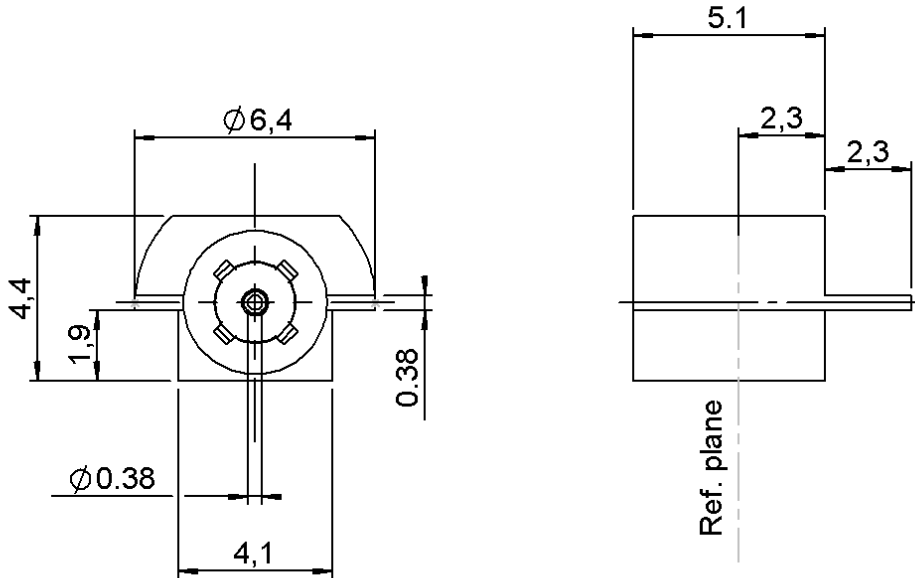
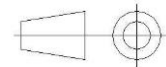

COMPONENTS	MATERIALS	PLATING (µm)
Body	STAINLESS STEEL	GOLD 1.3 OVER NICKEL2
Center contact	BERYLLIUM COPPER	GOLD 1.27 OVER NICKEL 1.27
Outer contact	-	
Insulator	PTFE	
Gasket		
Others parts		
-	-	-
-	-	-

PAGE 2/4	ISSUE 04-01-17E	SERIES SMP	PART NUMBER R222423320
----------	------------------------	-------------------	-------------------------------

PACKAGING

Standard	Unit	Other
100	Contact us	Contact us

ELECTRICAL CHARACTERISTICS

Impedance		50	Ω
Frequency		0-40*	GHz
VSWR	1.5** +	0,0000	x F(GHz) Maxi
Insertion loss		0.12*	√F(GHz) dB Maxi
RF leakage	- (NA	- F(GHz) dB Maxi
Voltage rating		335	Veff Maxi
Dielectric withstanding voltage		500	Veff mini
Insulation resistance		5000	MΩ mini

ENVIRONMENTAL

Operating temperature	-65/+165	°C
Hermetic seal	NA	Atm.cm3/s
Panel leakage	NA	

MECHANICAL CHARACTERISTICS

Center contact retention			
Axial force – Mating End		6.8	N mini
Axial force – Opposite end		6.8	N mini
Torque		NA	N.cm mini
Recommended torque			
Mating		NA	N.cm
Panel nut		NA	N.cm
Mating life		500	Cycles mini
Weight		0,6600	g

SPECIFICATION

OTHER CHARACTERISTICS

Assembly instruction:

Others:

***Coaxial transmission line only**

****DC-18 Ghz**

****Performance strongly depends on layout and PCB material**

PAGE 3/4	ISSUE 04-01-17E	SERIES SMP	PART NUMBER R222423320
----------	-----------------	------------	------------------------

SOLDER PROCEDURE

- Deposition of solder paste 'Sn Ag4 Cu0.5' on mounting zone by screen printing application. We recommend a low residue flux.
We advise a thickness of 150 microns (.5.9 microinch). Verify that the edges of the zone are clean.
- Placement of the receptacle on the mounting zone with an automatic machine of 'pick and place' type.
Video camera is recommended for the positioning of the component. Adhesive agents must not be used on the receptacle.
- Soldering by infra-red reflow.
Below, please find the typical profile to use.
- Cleaning of printed circuit boards.
- Checking of solder joints and position of the component by visual inspection.

TEMPERATURE PROFILE

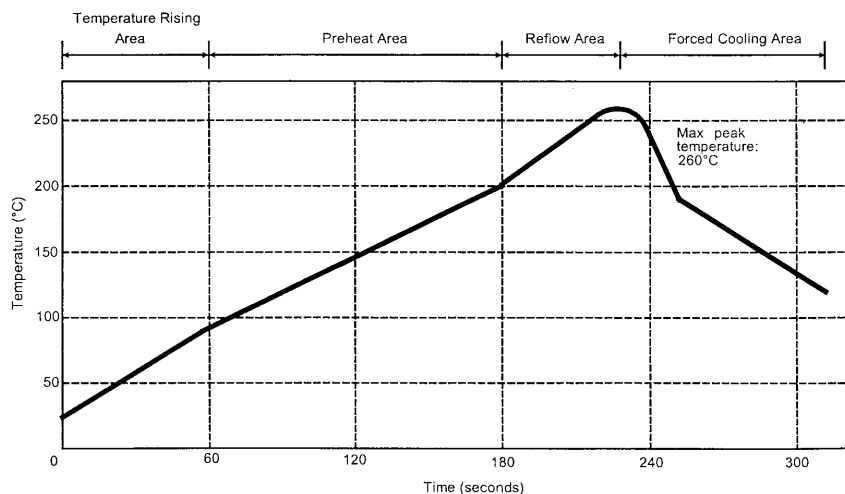

Parameter	Value	Unit
Temperature rising Area	1 - 4	°C/sec
Max Peak Temperature	260	°C
Max dwell time @260°C	10	sec
Min dwell time @235°C	20	sec
Max dwell time @235°C	60	sec
Temperature drop in cooling Area	-1 to - 4	°C/sec
Max dwell time above 100°C	420	sec

PAGE 4/4	ISSUE 04-01-17E	SERIES SMP	PART NUMBER R222423320
----------	-----------------	------------	------------------------

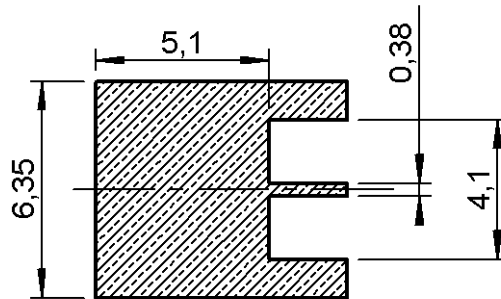

Shadow of receptacle
for video camera

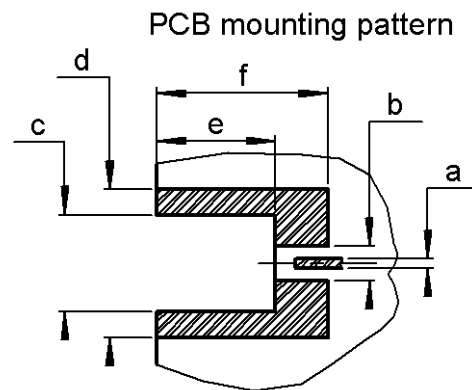

a	0,48
b	1,5
c	4,18 - 4,32
d	6,5
e	4,95 - 5,45
f	7,52