

Free and Total Chlorine Meter

860043
Instruction Manual

Table of Contents

1. Features	4
2. Specifications	5
3. Front Panel Description	7
4. Mode Selection	8
4. Calibration Procedure.....	8
5. Measuring Procedure	10
Measurement.....	10
Data Hold	11
Data Record	11
6. Battery Replacement.....	12
7. Warranty	12

Features:

The meter measures Free and Total Chlorine between 0.00 to 3.50 ppm (mg/L).

The measuring method is an adaptation of the USEPA Method 330.5 for waste water and Standard Method 4500-Cl G for drinking water.

The advanced optical system is based on a special narrow band LED lamp that allows most accurate and repeatable reading.

User friendly and powerful calibration functions are able to validate the performance of your meter at any time.

1.00 ppm Free standard solution and 1.00 ppm Total standard solution are included as standard accessories.

The unique optics structure enables the instrument to read with high resolution : 0.01 ppm (mg/L).

Splash waterproof on the front panel.

Jumbo LCD, easy readout.

Microprocessor circuit assures maximum possible accuracy, providing special functions and features.

Battery operated for field and on-site testing convenience.

Data hold function for freezing the desired value on display.

Records Maximum and Minimum reading with Recall.

Heavy duty & compact housing with hard carrying case, designed for easy carry out & operation.

Auto shut off feature to save battery life.

Applications: Test swimming pool, municipal water, food and beverage water, or other aqueous solution where fluid clarity is important.

Specifications:

Display	LCD size : 41 mm x 34 mm
Range	Free chlorine (CL) : 0.00 to 3.50 ppm (mg/L).
	Total chlorine (CL) : 0.00 to 3.50 ppm (mg/L).
Resolution	0.01 ppm (mg/L).
Accuracy	± 0.02 ppm (mg/L). @ 1.00 ppm (mg/L).
Light source	LED, 525 nm.
Light detector	Photo diode.
Method	The measuring method is an adaptation of the USEPA Method 330.5 and Standard Method 4500-Cl G. Note: The reaction between free (total) chlorine and the DPD reagent cause a pink tint in the sample.
Response time	Less than 10 seconds.
Sample volume	10 mL.
Data Hold	Freeze the display reading.
Memory Recall	Maximum & Minimum value.
Display Sampling Time	Approx. 1 second.
Power off	Auto shut off saves battery life or manual off by push button.
Calibration points	Zero chlorine. 1.00 ppm (Free chlorine). 1.00 ppm (Total chlorine).
Operating Temperature	0 to 50 °C.
Operating Humidity	Less than 85% R.H.
Power Supply	DC 1.5 V battery (UM4, AAA) x 6 PCs, or equivalent.

Power Current	Stand by Approx. DC 4 mA.
	Testing Approx. DC 12 mA.
Weight	320 g/0.70 LB. Battery is included.
Dimension	155 x 76 x 62 mm (6.1 x 3.0 x 2.4 inch)
Accessories Included	<ul style="list-style-type: none"> • Instruction manual1 PC • 1.0 ppm Free Chlorine standard solution, (LUTU-CF).....1 PC • 1.0 ppm Total Chlorine standard solution, (LUTU-CT).....1 PC • Zero Chlorine standard solution, (LUTU-CL).....1 PC • Empty testing bottle.....2 PCs • Clean cloth.....1 PC • Free Chlorine DPD powder.....10 PCs • Total Chlorine DPD powder.....10 PCs
Optional Accessories	<ul style="list-style-type: none"> • Free Chlorine DPD powder (LUCFP-10) • Total Chlorine DPD powder (LUCTP-10) • Empty testing bottle (LUTU-CELL) • 1.0 ppm Free Chlorine standard solution, (LUTU-CF) • 1.0 ppm Total Chlorine standard solution, (LUTU-CT) • Zero Chlorine standard solution, (LUTU-CL)

Front Panel Description:

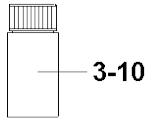

3-10

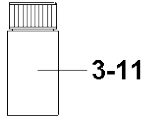

3-11

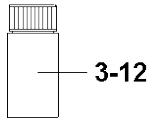

3-12

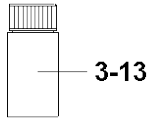

3-13

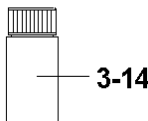

3-14

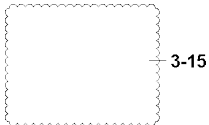

3-15



3-16



3-17

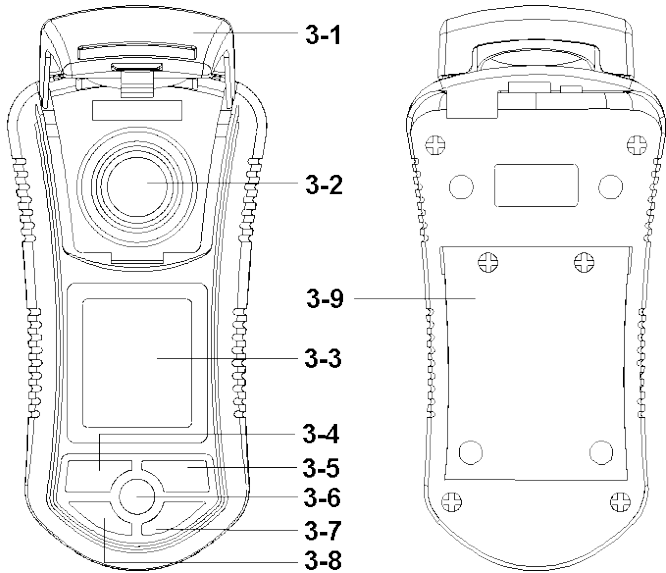

3-1 - Test Chamber Cover

3-2 - Test Chamber

3-3 - Display

3-4 - Hold Button

3-5 - TEST/CAL Button

3-6 - Power Button

3-7 - ZERO Button

3-8 - REC/MAX/MIN Button

3-9 - Battery Compartment

3-10 - Free Chlorine 1.0 ppm standard

3-11 - Total Chlorine 1.0 ppm standard

3-12 - Zero Chlorine standard

3-13 - Empty testing bottle 1

3-14 - Empty testing bottle 2

3-15 - Cleaning Cloth

3-16 - Free Chlorine DPD power (10pcs)

3-17 - Total Chlorine DPD power (10pcs)

Mode Selection:

Follow these steps to switch between Free and Total Chlorine testing modes.

1) With the meter off, press and hold the HOLD button and the REC/MAX/MIN button. While continuing to hold the HOLD and the REC/MAX/MIN button, press the Power button. The unit will enter the selection mode and display the current mode selected.

2) Press the TEST/CAL button to switch between Free and Total modes.

3) Press the REC/MAX/MIN button to confirm and save the mode into memory.

Note:

- For swimming pool applications, the Free Chlorine function is typically used.

- For industrial water applications, the Total Chlorine function is typically used.

Calibration Procedure:

1) The meter can be calibrated under the following calibration points:

Free Chlorine	Total Chlorine
- Zero ppm	- Zero ppm
- 1.00 ppm	- 1.00 ppm

Note: The calibration procedures for the "Total Chlorine" and the "Free Chlorine" are independent of each other.

2) Calibration requires the following two solutions.

- Zero Chlorine standard

- 1.0 ppm standard (Free or Total)

Calibration Procedure (continued):

3) Follow the steps below to perform calibration of the zero and 1.0ppm standards

1) Open the test chamber, place the zero chlorine standard in the chamber and close the chamber lid.

Note: Be sure the testing bottle is seated fully and oriented correctly. The white mark on the bottle should point towards the white mark on the test chamber.



2) Turn on the meter. The meter will display the current mode (Free or Total) briefly then will display CAL 0.

3) Press the Zero button. The meter will show CAL 0.00, then start flashing TEST. Once complete, the meter will display 0.00 ppm. (Note: this step is not part of the calibration process, this step sets the zero point for the meter at power up)

4) Press and hold the TEST/CAL button until CAL is displayed on the display then release the button. Press the TEST/CAL button again to enter the calibration function.

5) 0.00 PPM and CAL will be displayed. With the zero chlorine standard in the chamber, press the TEST/CAL button and CAL will begin to flash on the screen. Once complete, 1.00 ppm and CAL will be displayed.

6) Replace the zero chlorine standard in the test chamber with the 1.00 ppm chlorine standard. Then press the TEST/CAL button. CAL will begin to flash on the screen. Once complete, the unit will display 1.00 ppm.

7) Calibration is now complete and the meter is ready to use. (Note: It is recommended to perform the calibration at least once per day/use)

Measuring Procedure:

Note: Be sure to selected the appropriated measurement mode before performing a measurement. Refer to the Mode Selection.

1) Fill the testing bottle to the 10ML line with test sample.

Note :
Be sure to fill the testing bottle to the top of the 10ml line.

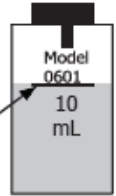

2) Open the test chamber and place the test sample in the chamber and close the chamber lid.

Note: Be sure the testing bottle is seated fully and oriented correctly. The white mark on the bottle should point towards the white mark on the test chamber.

3) Turn on the meter. The meter will display the current mode (Free or Total) briefly then will display CAL 0.

4) Press the Zero button. The meter will show CAL 0.00, then start flashing TEST. Once complete, the meter will display 0.00 ppm.

(Note: this step is not part of the calibration process, this step sets the zero point for the sample at power up)

5) Open the test chamber and remove the testing bottle. Open the test bottle and add the Free or Total DPD powder. Close the test bottle and shake bottle for at least 10 seconds.

6) Wait approximately one minute, then insert the test bottle back in to the test chamber and close the lid.

7) Press the TEST/CAL button, the display will flash TEST. Once complete, the display will show the measurement value.

Note: After testing, you should wash the testing bottle with distilled water.

Measuring Procedure (Continued):

Data Hold Function

1) During the measurement, pressing the HOLD button once will hold the measured value and will display a HOLD symbol.

Note: Press the HOLD button once again to release the data hold function.

Data Record Function

Note: The data record function only records the maximum and minimum readings.

Press the REC/MAX/MIN button once to start the data record function and a REC symbol will be shown on the display.

While REC function is active:

1) Press the REC/MAX/MIN button once to display the maximum value recorded and a MAX REC symbol will be shown on the display.

2) Press the REC/MAX/MIN button once again to display the minimum value recorded and a MIN REC symbol will be shown on the display.

Note: If you want to delete the maximum or minimum value, press the HOLD button while viewing the value and the display will return to the REC symbol only.

Note: To exit the REC function, press and hold the REC/MAX/MIN button until the REC symbol disappears.

Battery Replacement:

1) When the left corner of LCD display shows , it is necessary to replace the battery. However, in-spec measurements can still be made for several hours after low battery indicator appears before the instrument become inaccurate.

2) Open the Battery Cover by unscrewing the cover and slide the Battery Cover away from the instrument and remove the battery.

3) Replace with 1.5 V battery (AAA, Alkaline/heavy duty) x 6 PCs, and reinstate the cover.

4) Make sure the battery cover is secured after changing the battery.

Warranty:

Sper Scientific warrants this product against defects in materials and workmanship for a period of one (1) year from the date of purchase, and agrees to repair or replace any defective unit without charge. If your model has since been discontinued, an equivalent Sper Scientific product will be substituted if available. This warranty does not cover sample vials, batteries, battery leakage, or damage resulting from accident, tampering, misuse, or abuse of the product. Opening the meter to expose its electronics will void the warranty. To obtain warranty service, ship the unit postage prepaid to:

SPER SCIENTIFIC LTD.
8281 E. Evans Rd., Suite #103
Scottsdale, AZ 85260
(480) 948-4448

The defective unit must be accompanied by a description of the problem and your return address. Register your product online at www.sperwarranty.com within 10 days of purchase.

Please note: The most current version of the manual can always be found at www.sperdirect.com