

4

3

2

1

THIS DRAWING IS UNPUBLISHED.

RELEASED FOR PUBLICATION

REVISIONS

© COPYRIGHT - By -

ALL RIGHTS RESERVED.

P	LTR	DESCRIPTION	DATE	DWN	APVD
	B1	ECR-16-005292	12APR2016	T.Q	W.H

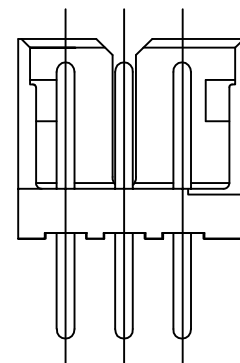
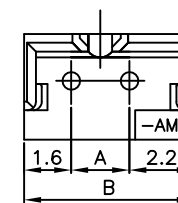
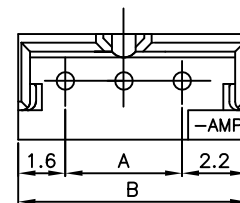
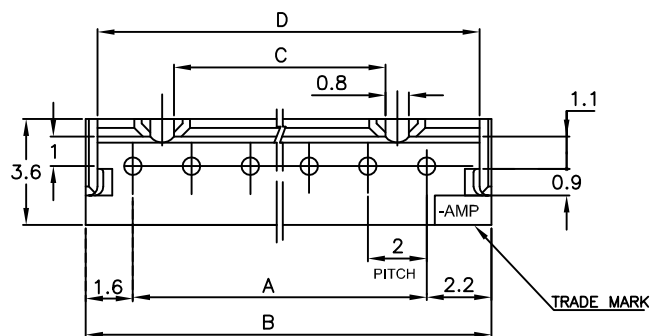

3 POS.

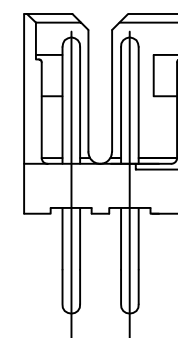

2 POS.

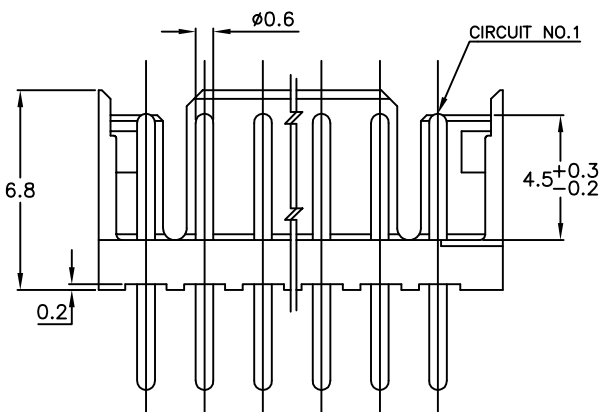
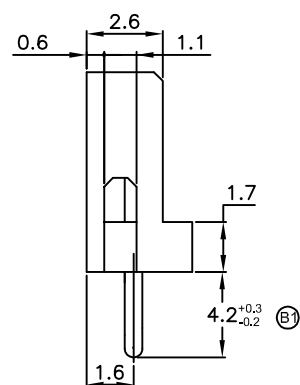

4~15 Pos.

NOTES:

- 1.MATERIAL: HOUSING - NYLON 66 (UL94V-0)
POST - TIN BRASS
- 2.THIS PRODUCT IS "NO-KINK" VERSION OF P/N
- 3.MATING RECEPTACLE P/N 173977 (AWG#26~28)
179694 (AWG#24)
MATING CRIMP II CONTACT P/N 179227 (AWG#22~26)
179609 (AWG#26~30)
MATING CRIMP II HOUSING P/N 179228

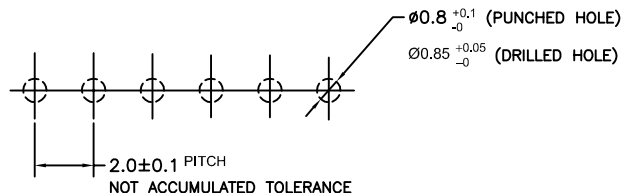

RECOMMENDABLE PCB LAYOUT (PCB THK:0.8-1.6)

TOLERANCES UNLESS OTHERWISE SPECIFIED:

- 10 > * : ±0.2
- 30 > * > 10 : ±0.25
- 100 > * > 30 : ±0.3
- ANGLE : ±3°

THIS DRAWING IS A CONTROLLED DOCUMENT.

DIMENSIONS: mm

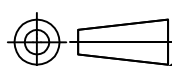

MATERIAL: SEE NOTE

TOLERANCES UNLESS OTHERWISE SPECIFIED:

- 0 PLC ± -
- 1 PLC ± -
- 2 PLC ± -
- 3 PLC ± -
- 4 PLC ± -
- ANGLES ± -

FINISH: SEE NOTE

DWN	C.ZHU	10JAN11
CHK	S.YAO	10JAN11
APVD	S.YAO	10JAN11
PRODUCT SPEC	108-60016	
APPLICATION SPEC	-	
WEIGHT	-	
CUSTOMER DRAWING		

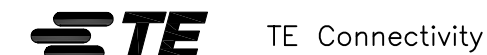

NAME: POST HEADER ASS'Y (V) NO-KINK TYPE LONG POST (AMP CT CONNECTOR 2mm PITCH)

SIZE	CAGE CODE	DRAWING NO	RESTRICTED TO
A3	00779	C=1932811	-
SCALE	SHEET	REV	
5:1	1 OF 1	B1	

1932811-3	3	4	7.8	-	7.0
NATURAL	Pos.	A	B	C	D
PART NO.					