

## Phase-Cut Dimmable and Active PFC for LED lighting With High Voltage MOSFET Integrated

### DESCRIPTION

The TS19830CS is a phase-cut (TRIAC) dimmable constant current control IC with active power factor correction for AC-DC LED lighting control. The TS19830CS is configurable as a non-isolated Buck-Boost converter which integrated 500V power MOSFET. It is compatible with many types of TRIAC dimmers including leading edge and trailing-edge. The IC achieves a high power factor and low total harmonic distortion (THD) and guarantees constant current accuracy to  $<\pm 2.5\%$  using Discontinuous Conduction Mode (DCM) operation. The TS19830CS has built-in protection circuits such as over temperature protection by current degeneration, VCC overvoltage protection and system output open/short circuit protection.

### FEATURES

- Phase cut dimmable
- Integrated 500V MOSFET
- Low THD  $<10\%$
- Good dimmer compatibility for 120/230V<sub>AC</sub> Lamps
- Constant Current Accuracy within  $\pm 2.5\%$
- High Power Factor  $>0.9$
- Low BOM Cost Design
- Discontinuous Conduction Mode Control (DCM)
- LED Open Protection
- LED Short protection
- Over Current Protection (OCP)
- Over Thermal Protection (OTP)
- Compliant to RoHS Directive 2011/65/EU and in accordance to WEEE 2002/96/EC.
- Halogen-free according to IEC 61249-2-21

### APPLICATION

- LED lighting
- Down lights, Tube lamps, PAR Lamps, Bulbs

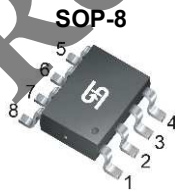

#### Pin Definition:

- |        |          |
|--------|----------|
| 1. VCC | 8. GND   |
| 2. CS  | 7. NC    |
| 3. COM | 6. DRAIN |
| 4. CL  | 5. DRAIN |

Note: MSL 3 (Moisture Sensitivity Level) per J-STD-020

### TYPICAL APPLICATION CIRCUIT

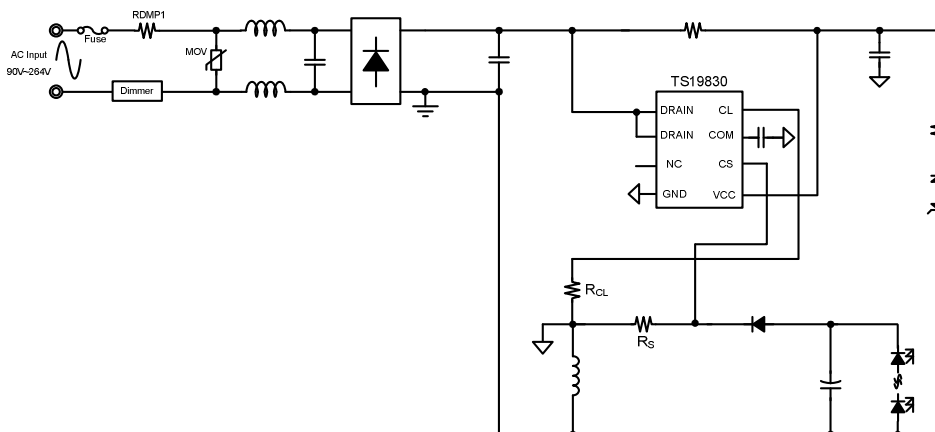

<b>ABSOLUTE MAXIMUM RATINGS</b> (Note 1)			
<b>PARAMETER</b>	<b>SYMBOL</b>	<b>LIMIT</b>	<b>UNIT</b>
Power Supply Pin	$V_{CC}$	40	V
CS Voltage to GND	$V_{CS}$	-0.3 to 5.5	V
DRAIN Voltage to GND	$V_{DRAIN}$	-0.3 to 500	V
CS Voltage to GND	$V_{CS}$	-0.3 to 5.5	V
CL Voltage to GND	$V_{CL}$	-0.3 to 5.5	V
COM Voltage to GND	$V_{COM}$	-0.3 to 5.5	V
Junction Temperature Range	$T_J$	-40 to +150	°C
Storage Temperature Range	$T_{STG}$	-65 to +150	°C
Lead Temperature (Soldering 10s)	$T_{LEAD}$	260	°C
Power Dissipation @ $T_A=25^\circ\text{C}$	$P_D$	0.6	W
ESD Rating (Human Body Mode) (Note2)	HBM	2	kV
ESD Rating (Machine Mode) (Note 2)	MM	200	V

<b>THERMAL PERFORMANCE</b>			
<b>PARAMETER</b>	<b>SYMBOL</b>	<b>LIMIT</b>	<b>UNIT</b>
Thermal Resistance - Junction to Case	$R_{\theta JC}$	50	°C/W
Thermal Resistance - Junction to Ambient	$R_{\theta JA}$	208	°C/W

**Note:**  $R_{\theta JA}$  is the sum of the junction-to-case and case-to-ambient thermal resistances. The case thermal reference is defined at the solder mounting surface of the drain pins.  $R_{\theta JA}$  is guaranteed by design while  $R_{\theta CA}$  is determined by the user's board design.  $R_{\theta JA}$  shown below for single device operation on FR-4 PCB in still air. Thermal Resistance is specified with the component mounted on a low effective thermal conductivity test board in free air at  $T_A=25^\circ\text{C}$ .

<b>RECOMMENDED OPERATING CONDITIONS</b> (Note 3)			
<b>PARAMETER</b>	<b>SYMBOL</b>	<b>CONDITIONS</b>	<b>UNIT</b>
Power Supply Pin	$V_{CC}$	33	V
CL Voltage to GND	$V_{CL}$	-0.3 to 0.3	V
DRAIN Voltage to GND	$V_{DRAIN}$	-0.3 to 500	V
CS Voltage to GND	$V_{CS}$	-0.3 to 5	V
COM Voltage to GND	$V_{COM}$	-0.3 to 5	V
Operating Junction Temperature Range	$T_J$	-40 to +125	°C
Operating Ambient Temperature Range	$T_{OPA}$	-40 to +85	°C

<b>ELECTRICAL SPECIFICATIONS</b> ( $V_{CC} = 18V, T_A = 25^{\circ}C$ unless otherwise noted)						
PARAMETER	SYMBOL	CONDITIONS	MIN	TYP	MAX	UNIT
<b>Supply Voltage</b>						
Start-up Current	$V_{CC(ST)}$	$V_{CC} = V_{UVLO(on)} - 1V$	--	45	--	$\mu A$
Operating Current	$I_{OPA}$	Operating @ 60kHz	--	2.1	2.6	mA
UVLO(off)	$V_{UVLO(off)}$		7	8	9	V
UVLO(on)	$V_{UVLO(on)}$		16	17.5	19	V
OVP Level on $V_{CC}$ Pin	$V_{OVP}$		29	31	33	V
<b>Voltage Feedback</b>						
Feedback Reference Voltage	$V_{FB}$		0.196	0.2	0.204	V
Transconductance	$g_m$		--	58	--	$\mu S$
Output Sink Current	$I_{O-SINK}$		--	5.8	--	$\mu A$
Output Source Current	$I_{O-SOURCE}$		--	5.8	--	$\mu A$
<b>Current Sensing</b>						
Open Loop Voltage	$V_{OLP}$	CS Pin Open	--	5	--	V
Leading-Edge Blanking Time	$t_{LEB}$		--	400	--	ns
Delay to Output	$t_{DELAY}$		--	100	--	ns
<b>Current Limit</b>						
CL Limit Voltage	$V_{OCP}$		--	0.3	--	V
<b>Switching Frequency</b>						
Start Frequency	$f_{STR}$		--	4.5	--	kHz

<b>ELECTRICAL SPECIFICATIONS</b> ( $V_{CC} = 18V, T_A = 25^{\circ}C$ unless otherwise noted)						
PARAMETER	SYMBOL	CONDITIONS	MIN	TYP	MAX	UNIT
<b>MOSFET section</b>						
Drain-Source Breakdown Voltage	$BV_{DS}$		500	--	--	V
Drain-Source On Resistance	$R_{DS(ON)}$		--	2.3	--	$\Omega$
<b>Thermal Section</b> (Note 5,6)						
Thermal Shutdown			--	150	--	$^{\circ}C$
Thermal Shutdown Release			--	120	--	$^{\circ}C$

**Note:**

- Stresses listed as the above "Absolute Maximum Ratings" may cause permanent damage to the device. These are for stress ratings. Functional operation of the device at these or any other conditions beyond those indicated in the operational sections of the specifications is not implied. Exposure to absolute maximum rating conditions for extended periods may remain possibility to affect device reliability.
- Devices are ESD sensitive. Handling precaution recommended.
- Thermal Resistance is specified with the component mounted on a low effective thermal conductivity test board in free air at  $T_A = 25^{\circ}C$ .
- The device is not guaranteed to function outside its operating conditions.
- Guaranteed by design.
- Auto Recovery Type.

**ORDERING INFORMATION**

PART NO.	PACKAGE	PACKING
TS19830CS RLG	SOP-8	2,500pcs / 13"Reel

**BLOCK DIAGRAM**

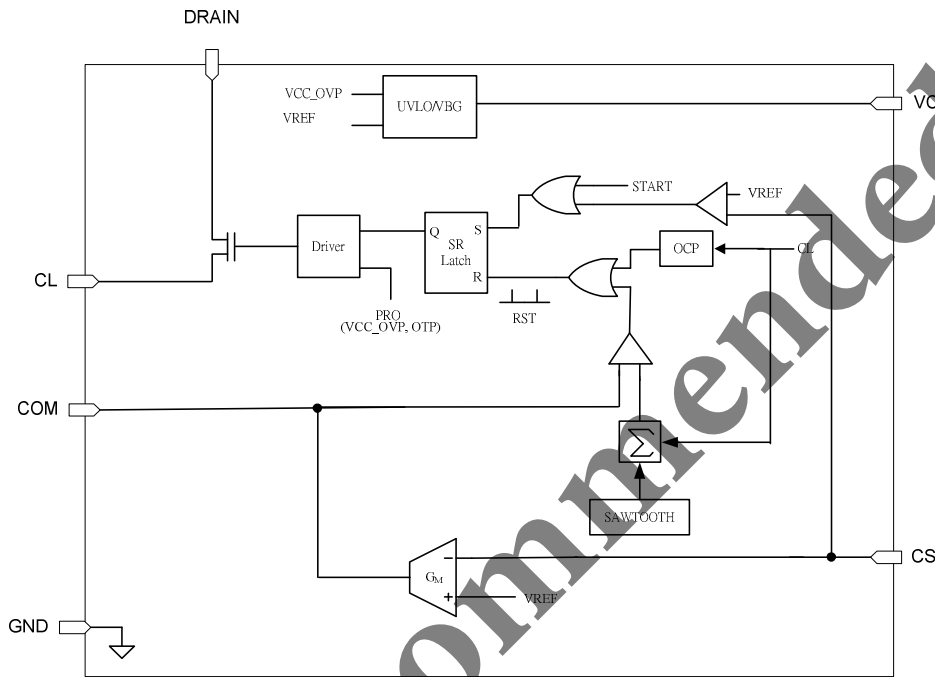

Fig. 1

**PIN DESCRIPTION**

PIN NO.	NAME	FUNCTION
1	V <sub>CC</sub>	Power supply pin for all internal circuitry.
2	CS	Input current sense pin.
3	COM	Output pin of error amplifier.
4	CL	Current limit.
5.6	DRAIN	High Voltage MOSFET Drain
7	N/C	No connect
8	GND	Ground return for all internal circuitry.

**APPLICATION INFORMATION**

**Start-up Current**

The typical start-up current is around 45μA. Very low start-up current allows the PWM controller to increase the value of start-up resistor and then reduce the power dissipation.

**UVLO(Under Voltage Lockout)**

A hysteresis UVLO comparator is implemented in TS19830. The turn-on and turn-off thresholds level are fixed at 17.5V and 8V respectively. This hysteresis shown in Fig.2 ensures that the start-up capacitor will be adequate to supply the chip during start-up. For quick start-up of the LED driver, the start-up resistor should be matched with the start-up capacitor.

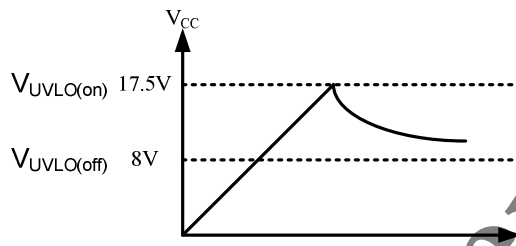

Fig. 2

**LEB(Leading-Edge Blanking)**

Each time the power MOSFET is switched on, a turn-on spike will inevitably occur at the sense resistor. To avoid fault trigger, a 400ns leading-edge blanking time is built in. Conventional RC filtering can therefore be omitted. During this blanking period, the current-limit comparator is disabled and cannot switch off the gate driver.

**OCP(Over Current Protection)**

The TS19830 has built-in cycle by cycle over current protection function on CL pin. As the CL pin voltage is larger than V<sub>OCP</sub> (0.3V), the gate output will be turned off immediately to avoid the driver board to be burned out.

**OVP (Over Voltage Protection) on V<sub>CC</sub>**

To prevent the LED driver from being damaged, the TS19830 has an implemented OVP function on V<sub>CC</sub>. When the V<sub>CC</sub> voltage is higher than the V<sub>OVP</sub> (31V), the output gate driver circuit will be shut down immediately to stop the switching of power MOSFET. The V<sub>CC</sub> pin OVP function is an auto recovery type protection. If the OVP condition happens, the pulses will be stopped until the V<sub>CC</sub> pin voltage is down to the UVLO off level. The TS19830 is working in an auto-recovery mode as shown in Fig. 3.

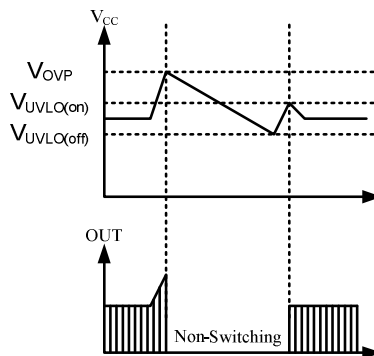
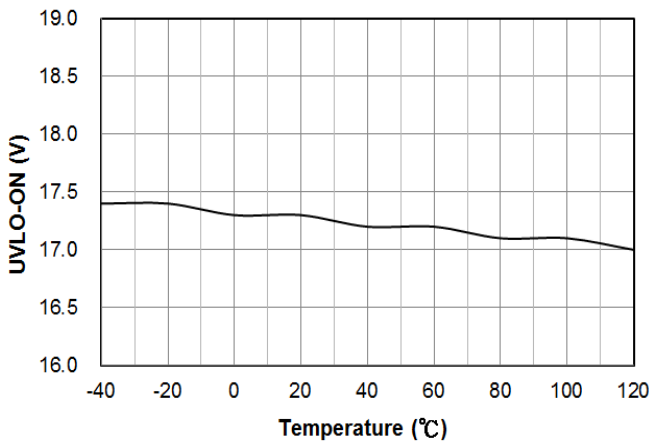
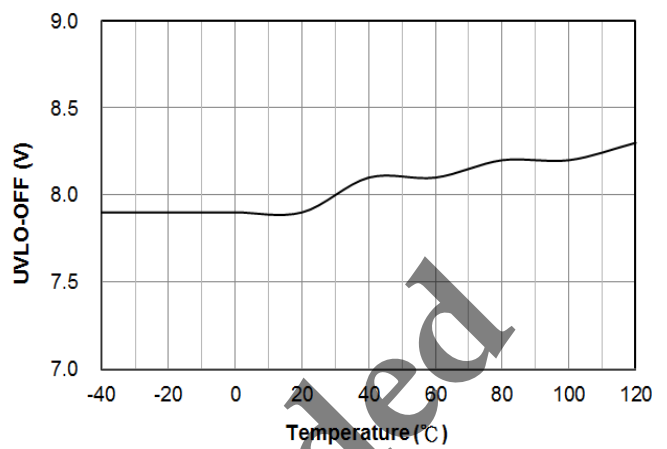

Fig. 3

**CHARACTERISTICS CURVES**



**Figure 1 – UVLO-ON vs. Ambient Temperature**



**Figure 2 – UVLO-OFF vs. Ambient Temperature**

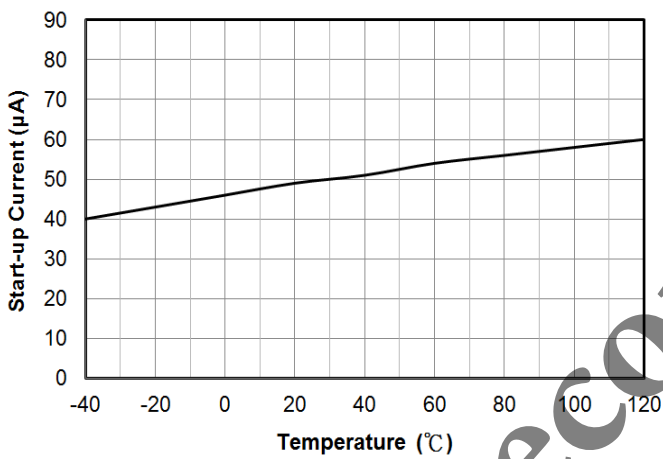

**Figure 3 – Start-up Current vs. Ambient Temperature**

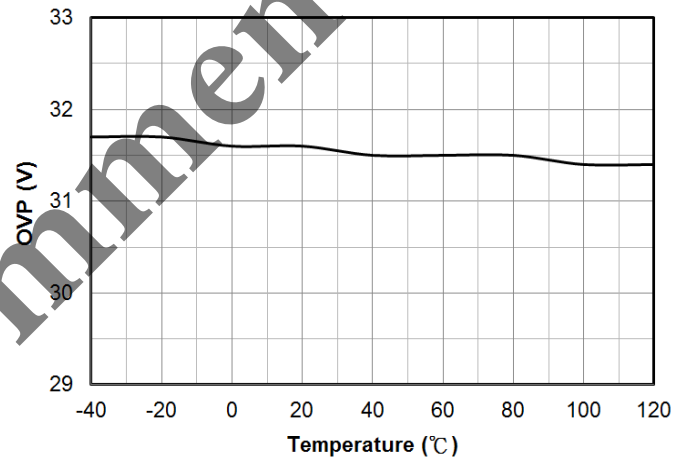

**Figure 4 – OVP vs. Ambient Temperature**

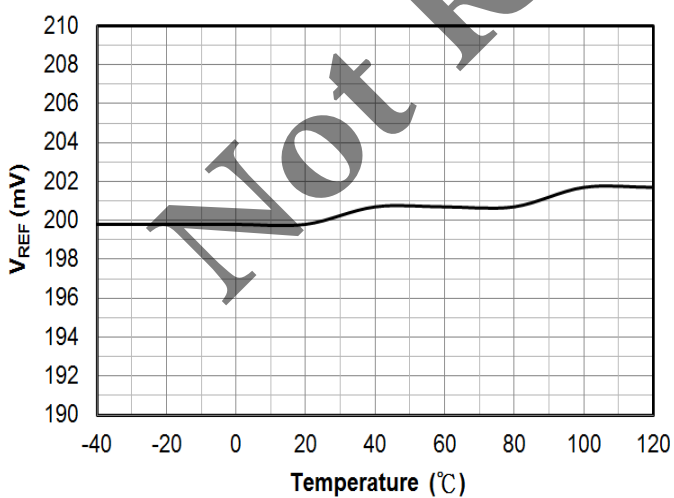

**Figure 5 – V<sub>REF</sub> vs. Ambient Temperature**

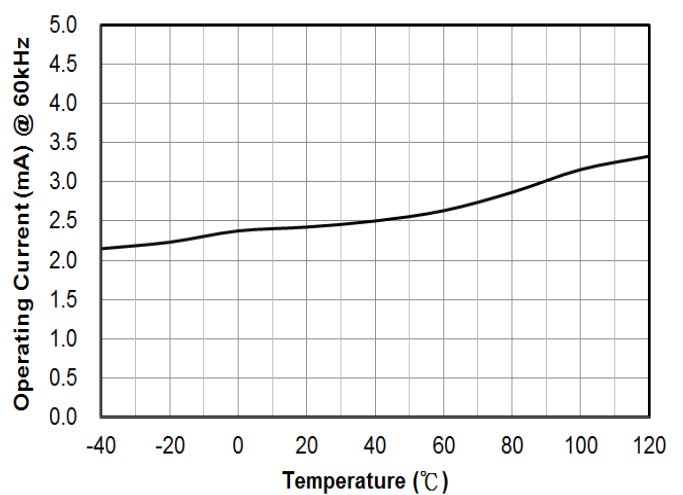

**Figure 6 – Operating Current vs. Ambient Temperature**

**PACKAGE OUTLINE DIMENSIONS** (Unit: Millimeters)

**SOP-8**

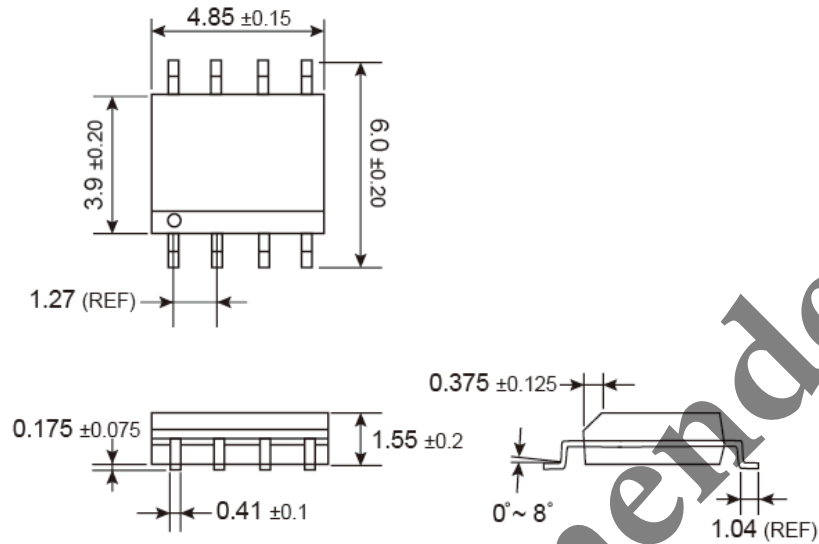

**SUGGESTED PAD LAYOUT** (Unit: Millimeters)

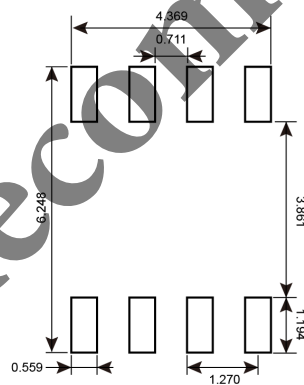

**MARKING DIAGRAM**

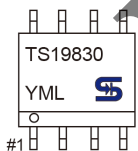

- Y** = Year Code
- M** = Month Code for Halogen Free Product
- O** =Jan    **P** =Feb    **Q** =Mar    **R** =Apr
- S** =May    **T** =Jun    **U** =Jul    **V** =Aug
- W** =Sep    **X** =Oct    **Y** =Nov    **Z** =Dec
- L** = Lot Code (1~9, A~Z)

**Not Recommended**

### **Notice**

Specifications of the products displayed herein are subject to change without notice. TSC or anyone on its behalf, assumes no responsibility or liability for any errors or inaccuracies.

Information contained herein is intended to provide a product description only. No license, express or implied, to any intellectual property rights is granted by this document. Except as provided in TSC's terms and conditions of sale for such products, TSC assumes no liability whatsoever, and disclaims any express or implied warranty, relating to sale and/or use of TSC products including liability or warranties relating to fitness for a particular purpose, merchantability, or infringement of any patent, copyright, or other intellectual property right.

The products shown herein are not designed for use in medical, life-saving, or life-sustaining applications. Customers using or selling these products for use in such applications do so at their own risk and agree to fully indemnify TSC for any damages resulting from such improper use or sale.