

TOP VIEW

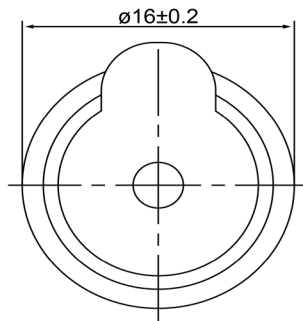

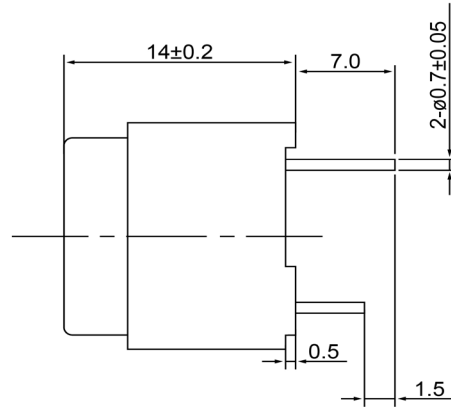

SIDE VIEW

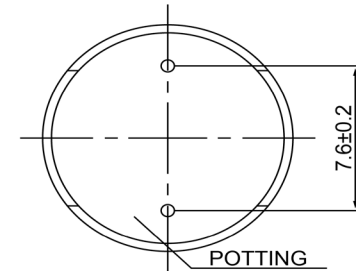

BOTTOM VIEW



Specifications			Notes	Revision History					
Description	Value	Unit		Version	Description	Date	Approved		
Technology	Electro-Mechanical		1) All dimensions are in mm unless otherwise noted 2) All parts meet RoHS	1	Released from Engineering	10/21/2013	J.S		
Resonant Frequency	2,048	(Hz)							
Rated Voltage	6	(V)							
SPL @ 10cm	85	(dBA)							
Coil Resistance	50	(ohm)							
Mount Type	Thru Hole								
Voltage Range	4 ~ 8	(V)							
Max Rated Current	40	(mA)							
Housing Material	NORYL								
Operating Temperature	-30 ~ +70	°C							
Storage Temperature	-40 ~ +85	°C							
Weight	5	(g)							
						<b>Electro-Mechanical Transducer</b>		<b>TE162006-3</b>	
						Drawn by A.B.	Date 10/21/2013	Checked by C.E.	Date 10/21/2013