

### Verpackt in Stangenprofil - Tube Packaging

Verpackungseinheit: 35 Stück - Packaging unit: 35 pcs

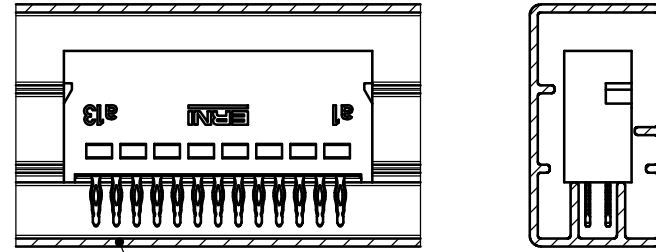

Stangenprofil - Tube Packaging  
044915

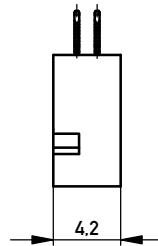
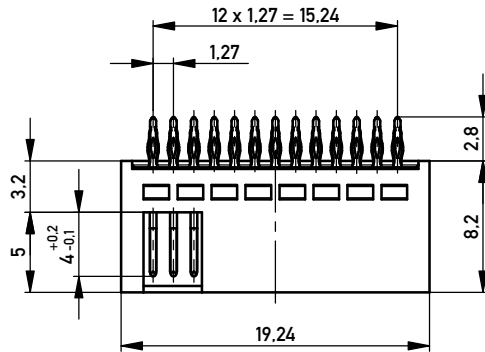
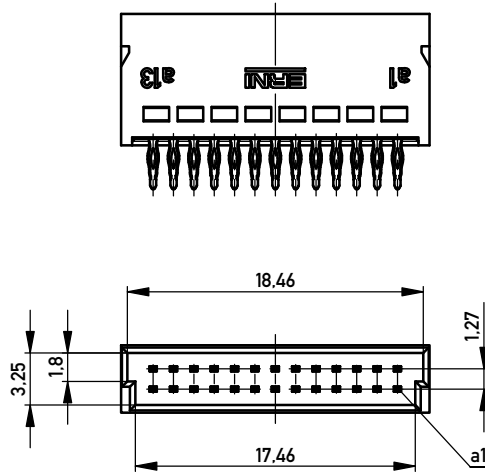

Lochbild für Leiterplatte  
Board hole pattern

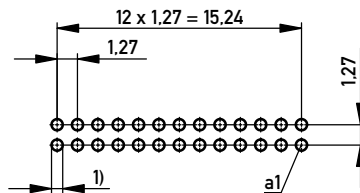



Anforderungsstufe 1  
Performance Level 1

Kontaktbereich vergoldet  
Mating Area gold plating

Anschlussbereich verzinkt 1-2 µm  
Terminal Area 1-2 µm tin plating

1) Lochaufbau siehe ERNI-Spezifikation 164062 Nr. 1  
hole design according to ERNI-specification 164062 No. 1

Information:	Tolerances	 All Dimensions in mm	Scale	3:1
	All rights reserved. Only for Information. To ensure that this is the latest version of this drawing, please contact one of the ERNI companies before using.		Designation <b>Messrl. SMC-Q 26-EE-BA 3</b> <b>Male SMC-Q 26-EE-type 3</b>	
Subject to modification without prior notice. Drawing will not be updated.		 www.ERNI.com	<b>064003</b>	
e	02.07.2015		Class SMCQ	
Index	Date	I A3		

Copyright by ERNI GmbH. Proprietary notice pursuant to ISO 9006 to be observed.