

# BLF6G15L-40RN; BLF6G15LS-40RN

Power LDMOS transistor

Rev. 3 — 1 September 2015

AMPLEON

Product data sheet

## 1. Product profile

### 1.1 General description

40 W LDMOS power transistor for base station applications at frequencies from 1450 MHz to 1550 MHz.

**Table 1. Typical performance**

Typical RF performance at  $T_{case} = 25\text{ °C}$  in a class-AB production test circuit.

Test signal	f (MHz)	$V_{DS}$ (V)	$P_{L(AV)}$ (W)	$G_p$ (dB)	$\eta_D$ (%)	ACPR (dBc)
2-carrier W-CDMA	1476 to 1511	28	2.5	22.5	13.5	-45 <sup>[1]</sup>

[1] Test signal: 3GPP test model 1; 64 DPCH; PAR = 8.4 dB at probability of 0.01 % on CCDF carrier; carrier spacing 5 MHz.

### 1.2 Features and benefits

- Typical 2-carrier W-CDMA performance at frequencies of 1476 MHz and 1511 MHz, a supply voltage of 28 V and an  $I_{DQ}$  of 375 mA:
  - ◆ Average output power = 2.5 W
  - ◆ Power gain = 22.5 dB
  - ◆ Efficiency = 13.5 %
  - ◆ ACPR = -45 dBc
- Easy power control
- Integrated ESD protection
- Enhanced ruggedness
- High efficiency
- Excellent thermal stability
- Designed for broadband operation (1450 MHz to 1550 MHz)
- Internally matched for ease of use
- Compliant to Restriction of Hazardous Substances (RoHS) Directive 2002/95/EC.

### 1.3 Applications

- RF power amplifiers for W-CDMA base stations and multi carrier applications in the 1450 MHz to 1550 MHz frequency range

## 2. Pinning information

Table 2. Pinning

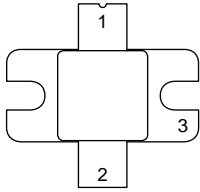
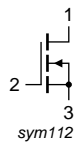
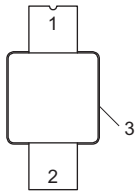
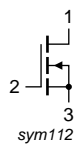
Pin	Description	Simplified outline	Graphic symbol
<b>BLF6G15L-40RN (SOT1135A)</b>			
1	drain		 sym112
2	gate		
3	source		
<b>BLF6G15LS-40RN (SOT1135B)</b>			
1	drain		 sym112
2	gate		
3	source		

[1] Connected to flange.

## 3. Ordering information

Table 3. Ordering information

Type number	Package		
	Name	Description	Version
BLF6G15L-40RN	-	flanged ceramic package; 2 mounting holes; 2 leads	SOT1135A
BLF6G15LS-40RN	-	earless flanged ceramic package; 2 leads	SOT1135B

## 4. Limiting values

Table 4. Limiting values

In accordance with the Absolute Maximum Rating System (IEC 60134).

Symbol	Parameter	Conditions	Min	Max	Unit
$V_{DS}$	drain-source voltage		-	65	V
$V_{GS}$	gate-source voltage		-0.5	+11	V
$T_{stg}$	storage temperature		-65	+150	°C
$T_j$	junction temperature		-	200	°C

## 5. Thermal characteristics

Table 5. Thermal characteristics

Symbol	Parameter	Conditions	Typ	Unit
$R_{th(j-case)}$	thermal resistance from junction to case	$T_{case} = 80\text{ °C}; P_L = 2.5\text{ W (CW)}$	1.30	K/W

## 6. Characteristics

**Table 6. Characteristics**

$T_j = 25\text{ }^\circ\text{C}$  per section; unless otherwise specified

Symbol	Parameter	Conditions	Min	Typ	Max	Unit
$V_{(BR)DSS}$	drain-source breakdown voltage	$V_{GS} = 0\text{ V}; I_D = 0.59\text{ mA}$	65	-	-	V
$V_{GS(th)}$	gate-source threshold voltage	$V_{DS} = 10\text{ V}; I_D = 59\text{ mA}$	1.4	1.8	2.4	V
$I_{DSS}$	drain leakage current	$V_{GS} = 0\text{ V}; V_{DS} = 28\text{ V}$	-	-	1.4	$\mu\text{A}$
$I_{DSX}$	drain cut-off current	$V_{GS} = V_{GS(th)} + 3.75\text{ V}; V_{DS} = 10\text{ V}$	-	9.4	-	A
$I_{GSS}$	gate leakage current	$V_{GS} = 11\text{ V}; V_{DS} = 0\text{ V}$	-	-	140	nA
$g_{fs}$	forward transconductance	$V_{DS} = 10\text{ V}; I_D = 58.9\text{ mA}$	-	0.5	-	S
$R_{DS(on)}$	drain-source on-state resistance	$V_{GS} = V_{GS(th)} + 3.75\text{ V}; I_D = 2.06\text{ A}$	-	0.32	-	$\Omega$

## 7. Application information

**Table 7. 2-carrier W-CDMA RF performance**

Class-AB production test circuit; PAR 8.4 dB at 0.01 % probability on CCDF; carrier spacing 5 MHz; 3GPP test model 1; 64 DPCH;  $f_1 = 1476\text{ MHz}; f_2 = 1511\text{ MHz};$  RF performance at  $V_{DS} = 28\text{ V}; I_{Dq} = 375\text{ mA}; T_{case} = 25\text{ }^\circ\text{C};$  unless otherwise specified.

Symbol	Parameter	Conditions	Min	Typ	Max	Unit
$P_{L(AV)}$	average output power		-	2.5	-	W
$G_p$	power gain	$P_{L(AV)} = 2.5\text{ W}$	19.8	22.5	-	dB
$RL_{in}$	input return loss	$P_{L(AV)} = 2.5\text{ W}$	-	-16	-11	dB
$\eta_D$	drain efficiency	$P_{L(AV)} = 2.5\text{ W}$	11.5	13.5	-	%
ACPR	adjacent channel power ratio	$P_{L(AV)} = 2.5\text{ W}$	-	-45	-40	dBc

### 7.1 Ruggedness in Class-AB operations

The BLF6G15L-40RN and the BLF6G15LS-40RN are capable of withstanding a load mismatch corresponding to VSWR 10 : 1 through all phases under following conditions:  $V_{DS} = 28\text{ V}; I_{Dq} = 375\text{ mA}; P_L = 40\text{ W}; f = 1476\text{ MHz}$  (CW).

## 8. Test information

### 8.1 Impedance information

**Table 8. Typical impedance**

Measured load-pull data. Typical values per section.  $I_{Dq} = 330\text{ mA};$  main transistor  $V_{DS} = 28\text{ V}$   $Z_S$  and  $Z_L$  defined in [Figure 1](#).

f (MHz)	$Z_S$ ( $\Omega$ )	$Z_L$ ( $\Omega$ )
1450	4.4 – j5.9	5.5 – j4.6
1480	4.4 – j4.1	5.0 – j5.0
1510	6.4 – j4.7	5.0 – j5.0

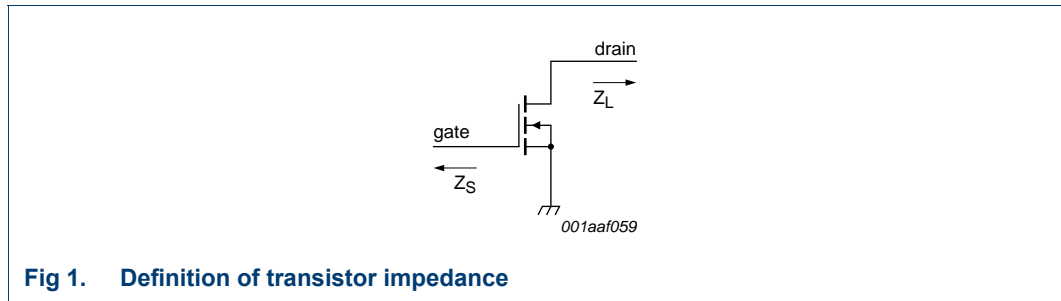

Fig 1. Definition of transistor impedance

## 8.2 One-tone graphs

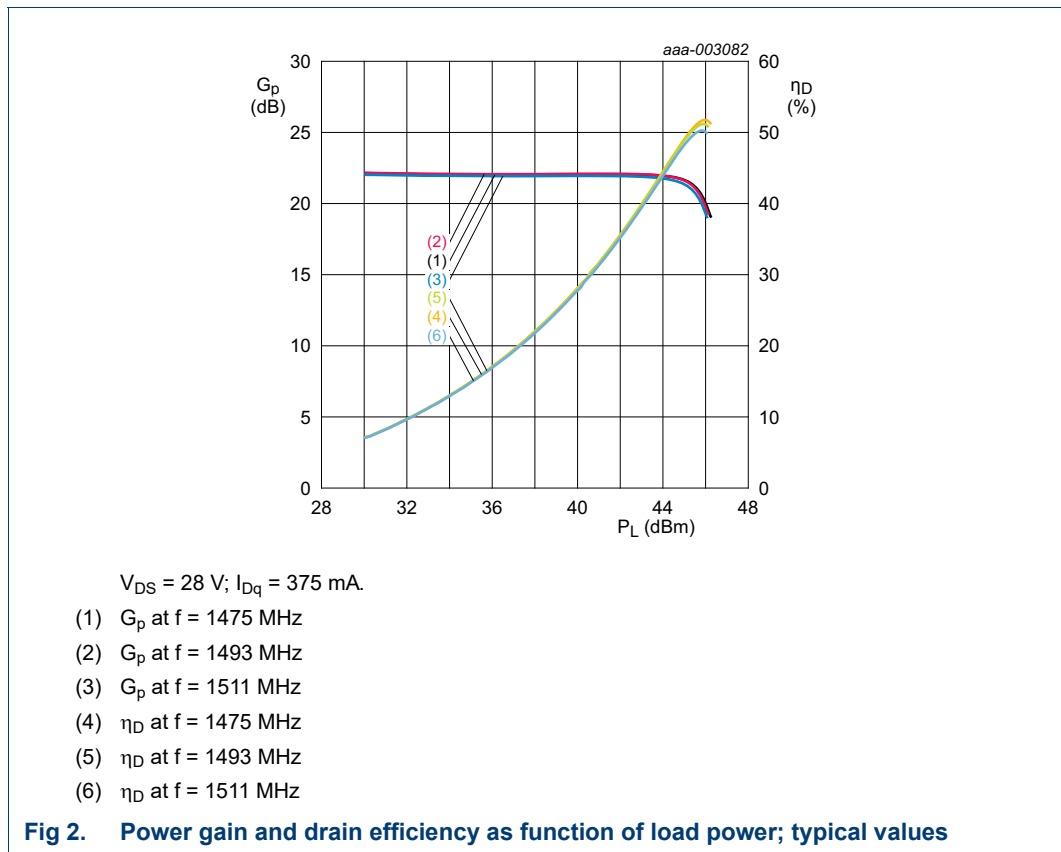
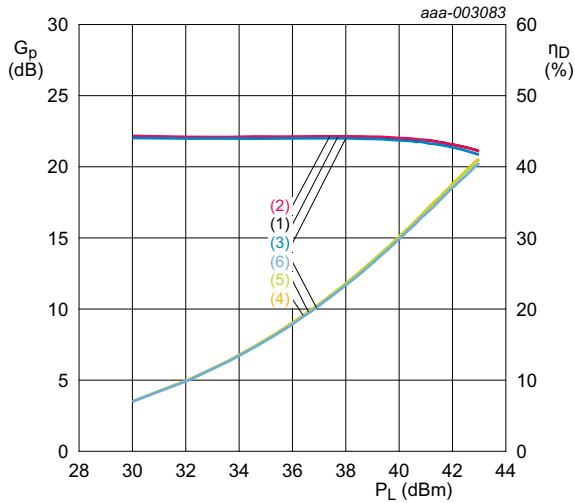

Fig 2. Power gain and drain efficiency as function of load power; typical values

### 8.3 2-Carrier W-CDMA graphs

3GPP, test model 1; 64 DPCH, PAR = 8.4 dB at 0.01 % probability, 5 MHz carrier spacing.



$T_{amb} = 25\text{ }^\circ\text{C}$ .

- (1)  $G_p$  at  $f = 1475\text{ MHz}$
- (2)  $G_p$  at  $f = 1493\text{ MHz}$
- (3)  $G_p$  at  $f = 1511\text{ MHz}$
- (4)  $\eta_D$  at  $f = 1475\text{ MHz}$
- (5)  $\eta_D$  at  $f = 1493\text{ MHz}$
- (6)  $\eta_D$  at  $f = 1511\text{ MHz}$

**Fig 3. Power gain and drain efficiency as function of load power; typical values**

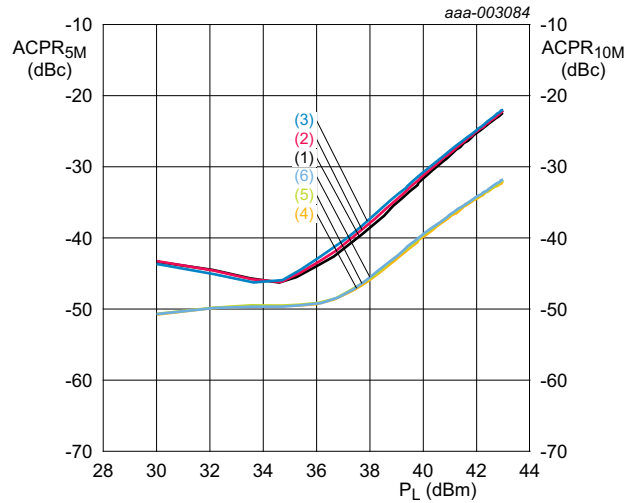

$T_{amb} = 25\text{ }^\circ\text{C}$ .

- (1)  $ACPR_{5M}$  at  $f = 1475\text{ MHz}$
- (2)  $ACPR_{5M}$  at  $f = 1493\text{ MHz}$
- (3)  $ACPR_{5M}$  at  $f = 1511\text{ MHz}$
- (4)  $ACPR_{10M}$  at  $f = 1475\text{ MHz}$
- (5)  $ACPR_{10M}$  at  $f = 1493\text{ MHz}$
- (6)  $ACPR_{10M}$  at  $f = 1511\text{ MHz}$

**Fig 4. Adjacent channel power ratio (5 MHz and 10 MHz) as a function of load power; typical values**

8.4 Test circuit

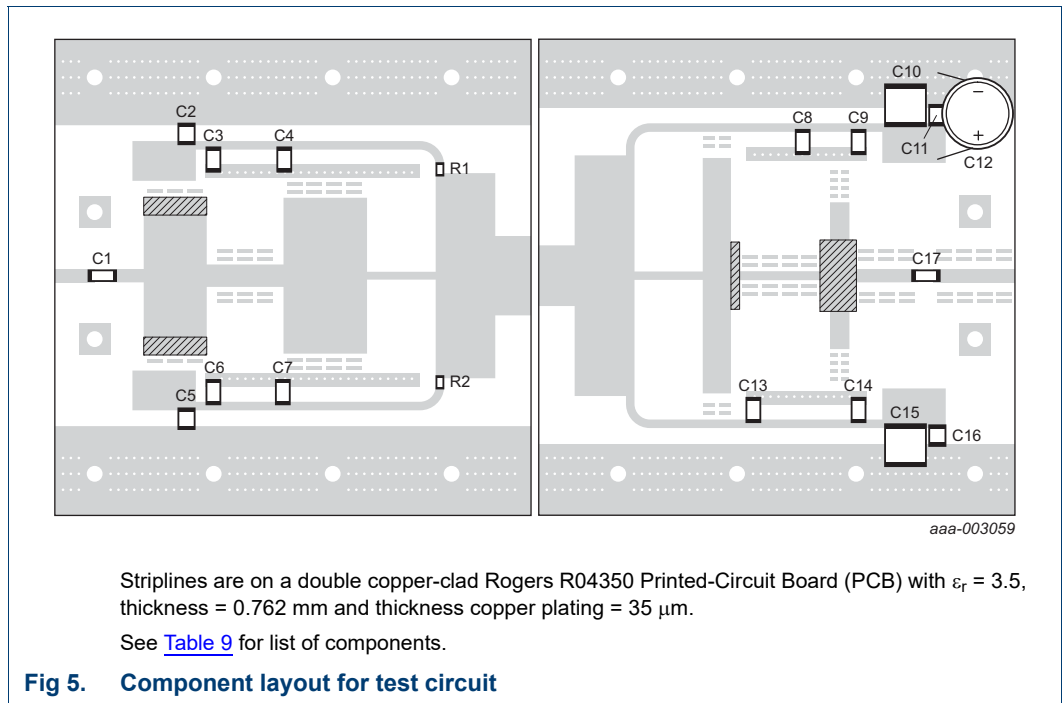

**Table 9. List of components**

For test circuit, see [Figure 5](#).

Component	Description	Value	Remarks
C1, C17	multilayer ceramic chip capacitor	24 pF	[1]
C3, C6	multilayer ceramic chip capacitor	68 pF	[2]
C4, C7, C8	multilayer ceramic chip capacitor	150 pF	[2]
C9, C14	multilayer ceramic chip capacitor	47 pF	[2]
C13	multilayer ceramic chip capacitor	15 pF	[2]
C2, C5, C11, C16	multilayer ceramic chip capacitor	10 $\mu\text{F}$	[3]
C10, C15	multilayer ceramic chip capacitor	0.1 $\mu\text{F}$	[3]
C12	electrolytic capacitor	2200 $\mu\text{F}$ , 50 V	
R1, R2	chip resistor	15 $\Omega$	

[1] American technical ceramics type 800B or capacitor of same quality.

[2] American technical ceramics type 100B or capacitor of same quality.

[3] TDK or capacitor of same quality.

9. Package outline

Flanged ceramic package; 2 mounting holes; 2 leads

SOT1135A

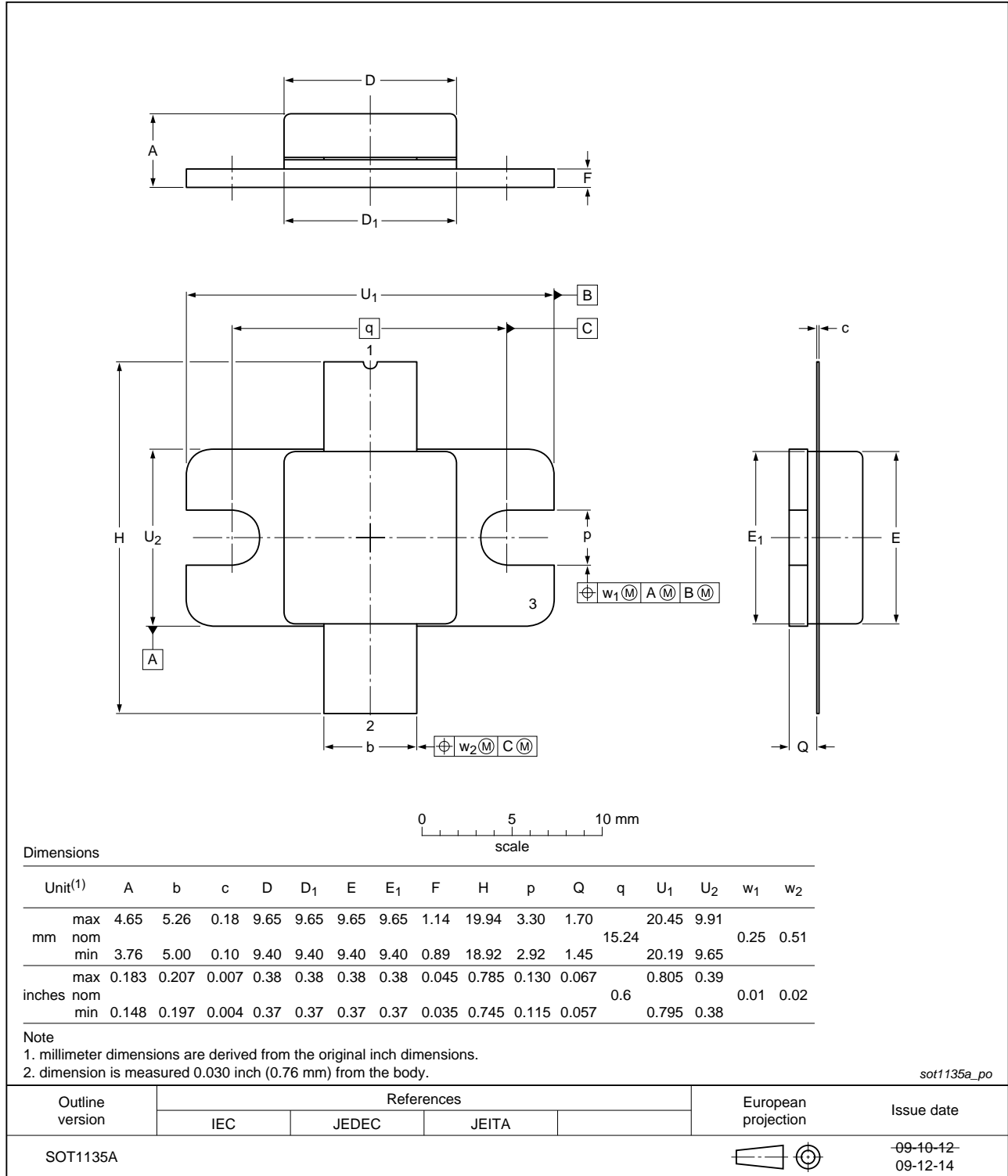
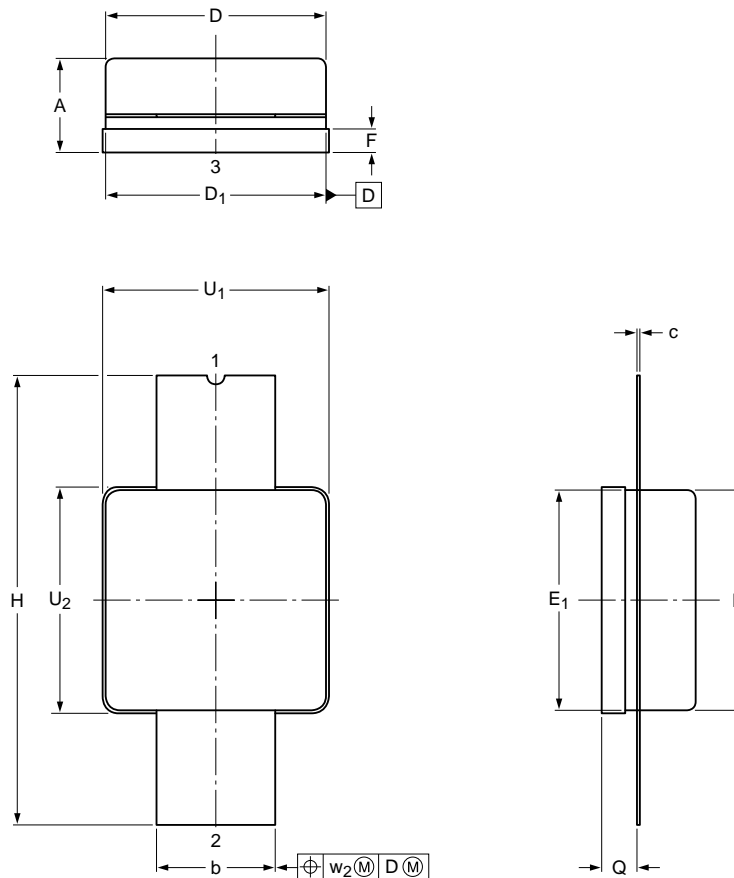

Fig 6. Package outline SOT1135A

Earless flanged ceramic package; 2 leads

SOT1135B



Dimensions

Unit <sup>(1)</sup>	A	b	c	D	D <sub>1</sub>	E	E <sub>1</sub>	F	H	Q	U <sub>1</sub>	U <sub>2</sub>	w <sub>2</sub>
mm	max	4.65	5.26	0.18	9.65	9.65	9.65	1.14	19.94	1.70	9.91	9.91	0.51
	nom												
	min	3.76	5.00	0.10	9.40	9.40	9.40	0.89	18.92	1.45	9.65	9.65	
inches	max	0.183	0.207	0.007	0.38	0.38	0.38	0.045	0.785	0.067	0.39	0.39	0.02
	nom												
	min	0.148	0.197	0.004	0.37	0.37	0.37	0.035	0.745	0.057	0.38	0.38	

Note

1. millimeter dimensions are derived from the original inch dimensions.
2. dimension is measured 0.030 inch (0.76 mm) from the body.

sot1135b\_po

Outline version	References			European projection	Issue date
	IEC	JEDEC	JEITA		
SOT1135B					-09-10-12- 09-12-14

Fig 7. Package outline SOT1135B



## 10. Handling information

### CAUTION



This device is sensitive to ElectroStatic Discharge (ESD). Observe precautions for handling electrostatic sensitive devices.

Such precautions are described in the *ANSI/ESD S20.20*, *IEC/ST 61340-5*, *JESD625-A* or equivalent standards.

## 11. Abbreviations

Table 10. Abbreviations

Acronym	Description
3GPP	3rd Generation Partnership Project
CCDF	Complementary Cumulative Distribution Function
CW	Continuous Wave
DPCH	Dedicated Physical Channel
ESD	ElectroStatic Discharge
LDMOS	Laterally Diffused Metal-Oxide Semiconductor
PAR	Peak-to-Average Ratio
RF	Radio Frequency
VSWR	Voltage Standing-Wave Ratio
W-CDMA	Wideband Code Division Multiple Access

## 12. Revision history

Table 11. Revision history

Document ID	Release date	Data sheet status	Change notice	Supersedes
BLF6G15L-40RN_6G15LS-40RN#3	20150901	Product data sheet	-	BLF6G15L-40RN_6G15LS-40RN v.2
Modifications:	<ul style="list-style-type: none"> <li>The format of this document has been redesigned to comply with the new identity guidelines of Ampleon.</li> <li>Legal texts have been adapted to the new company name where appropriate.</li> </ul>			
BLF6G15L-40RN_6G15LS-40RN v.2	20120514	Product data sheet	-	BLF6G15L-40RN_6G15LS-40RN v.1
BLF6G15L-40RN_6G15LS-40RN v.1	20111027	Objective data sheet	-	-

## 13. Legal information

### 13.1 Data sheet status

Document status <sup>[1][2]</sup>	Product status <sup>[3]</sup>	Definition
Objective [short] data sheet	Development	This document contains data from the objective specification for product development.
Preliminary [short] data sheet	Qualification	This document contains data from the preliminary specification.
Product [short] data sheet	Production	This document contains the product specification.

[1] Please consult the most recently issued document before initiating or completing a design.

[2] The term 'short data sheet' is explained in section "Definitions".

[3] The product status of device(s) described in this document may have changed since this document was published and may differ in case of multiple devices. The latest product status information is available on the Internet at URL <http://www.ampleon.com>.

### 13.2 Definitions

**Draft** — The document is a draft version only. The content is still under internal review and subject to formal approval, which may result in modifications or additions. Ampleon does not give any representations or warranties as to the accuracy or completeness of information included herein and shall have no liability for the consequences of use of such information.

**Short data sheet** — A short data sheet is an extract from a full data sheet with the same product type number(s) and title. A short data sheet is intended for quick reference only and should not be relied upon to contain detailed and full information. For detailed and full information see the relevant full data sheet, which is available on request via the local Ampleon sales office. In case of any inconsistency or conflict with the short data sheet, the full data sheet shall prevail.

**Product specification** — The information and data provided in a Product data sheet shall define the specification of the product as agreed between Ampleon and its customer, unless Ampleon and customer have explicitly agreed otherwise in writing. In no event however, shall an agreement be valid in which the Ampleon product is deemed to offer functions and qualities beyond those described in the Product data sheet.

Ampleon product can reasonably be expected to result in personal injury, death or severe property or environmental damage. Ampleon and its suppliers accept no liability for inclusion and/or use of Ampleon products in such equipment or applications and therefore such inclusion and/or use is at the customer's own risk.

**Applications** — Applications that are described herein for any of these products are for illustrative purposes only. Ampleon makes no representation or warranty that such applications will be suitable for the specified use without further testing or modification.

Customers are responsible for the design and operation of their applications and products using Ampleon products, and Ampleon accepts no liability for any assistance with applications or customer product design. It is customer's sole responsibility to determine whether the Ampleon product is suitable and fit for the customer's applications and products planned, as well as for the planned application and use of customer's third party customer(s). Customers should provide appropriate design and operating safeguards to minimize the risks associated with their applications and products.

Ampleon does not accept any liability related to any default, damage, costs or problem which is based on any weakness or default in the customer's applications or products, or the application or use by customer's third party customer(s). Customer is responsible for doing all necessary testing for the customer's applications and products using Ampleon products in order to avoid a default of the applications and the products or of the application or use by customer's third party customer(s). Ampleon does not accept any liability in this respect.

**Limiting values** — Stress above one or more limiting values (as defined in the Absolute Maximum Ratings System of IEC 60134) will cause permanent damage to the device. Limiting values are stress ratings only and (proper) operation of the device at these or any other conditions above those given in the Recommended operating conditions section (if present) or the Characteristics sections of this document is not warranted. Constant or repeated exposure to limiting values will permanently and irreversibly affect the quality and reliability of the device.

**Terms and conditions of commercial sale** — Ampleon products are sold subject to the general terms and conditions of commercial sale, as published at <http://www.ampleon.com/terms>, unless otherwise agreed in a valid written individual agreement. In case an individual agreement is concluded only the terms and conditions of the respective agreement shall apply. Ampleon hereby expressly objects to applying the customer's general terms and conditions with regard to the purchase of Ampleon products by customer.

**No offer to sell or license** — Nothing in this document may be interpreted or construed as an offer to sell products that is open for acceptance or the grant, conveyance or implication of any license under any copyrights, patents or other industrial or intellectual property rights.

**Export control** — This document as well as the item(s) described herein may be subject to export control regulations. Export might require a prior authorization from competent authorities.

### 13.3 Disclaimers

**Limited warranty and liability** — Information in this document is believed to be accurate and reliable. However, Ampleon does not give any representations or warranties, expressed or implied, as to the accuracy or completeness of such information and shall have no liability for the consequences of use of such information. Ampleon takes no responsibility for the content in this document if provided by an information source outside of Ampleon.

In no event shall Ampleon be liable for any indirect, incidental, punitive, special or consequential damages (including - without limitation - lost profits, lost savings, business interruption, costs related to the removal or replacement of any products or rework charges) whether or not such damages are based on tort (including negligence), warranty, breach of contract or any other legal theory.

Notwithstanding any damages that customer might incur for any reason whatsoever, Ampleon' aggregate and cumulative liability towards customer for the products described herein shall be limited in accordance with the *Terms and conditions of commercial sale* of Ampleon.

**Right to make changes** — Ampleon reserves the right to make changes to information published in this document, including without limitation specifications and product descriptions, at any time and without notice. This document supersedes and replaces all information supplied prior to the publication hereof.

**Suitability for use** — Ampleon products are not designed, authorized or warranted to be suitable for use in life support, life-critical or safety-critical systems or equipment, nor in applications where failure or malfunction of an

**Non-automotive qualified products** — Unless this data sheet expressly states that this specific Ampleon product is automotive qualified, the product is not suitable for automotive use. It is neither qualified nor tested in accordance with automotive testing or application requirements. Ampleon accepts no liability for inclusion and/or use of non-automotive qualified products in automotive equipment or applications.

In the event that customer uses the product for design-in and use in automotive applications to automotive specifications and standards, customer (a) shall use the product without Ampleon' warranty of the product for such automotive applications, use and specifications, and (b) whenever customer uses the product for automotive applications beyond Ampleon' specifications such use shall be solely at customer's own risk, and (c) customer fully indemnifies Ampleon for any liability, damages or failed product claims resulting from customer design and use of the product for automotive applications beyond Ampleon' standard warranty and Ampleon' product specifications.

**Translations** — A non-English (translated) version of a document is for reference only. The English version shall prevail in case of any discrepancy between the translated and English versions.

## 14. Contact information

---

For more information, please visit:  
<http://www.ampleon.com>

### 13.4 Trademarks

Notice: All referenced brands, product names, service names and trademarks are the property of their respective owners.

Any reference or use of any 'NXP' trademark in this document or in or on the surface of Ampleon products does not result in any claim, liability or entitlement vis-à-vis the owner of this trademark. Ampleon is no longer part of the NXP group of companies and any reference to or use of the 'NXP' trademarks will be replaced by reference to or use of Ampleon's own Any reference or use of any 'NXP' trademark in this document or in or on the surface of Ampleon products does not result in any claim, liability or entitlement vis-à-vis the owner of this trademark. Ampleon is no longer part of the NXP group of companies and any reference to or use of the 'NXP' trademarks will be replaced by reference to or use of Ampleon's own trademarks.

For sales office addresses, please visit:  
<http://www.ampleon.com/sales>

15. Contents

1 **Product profile** . . . . . 1

1.1 General description . . . . . 1

1.2 Features and benefits . . . . . 1

1.3 Applications . . . . . 1

2 **Pinning information** . . . . . 2

3 **Ordering information** . . . . . 2

4 **Limiting values** . . . . . 2

5 **Thermal characteristics** . . . . . 2

6 **Characteristics** . . . . . 3

7 **Application information** . . . . . 3

7.1 Ruggedness in Class-AB operations . . . . . 3

8 **Test information** . . . . . 3

8.1 Impedance information . . . . . 3

8.2 One-tone graphs . . . . . 4

8.3 2-Carrier W-CDMA graphs . . . . . 5

8.4 Test circuit . . . . . 6

9 **Package outline** . . . . . 7

10 **Handling information** . . . . . 9

11 **Abbreviations** . . . . . 9

12 **Revision history** . . . . . 9

13 **Legal information** . . . . . 10

13.1 Data sheet status . . . . . 10

13.2 Definitions . . . . . 10

13.3 Disclaimers . . . . . 10

13.4 Trademarks . . . . . 11

14 **Contact information** . . . . . 11

15 **Contents** . . . . . 12

Please be aware that important notices concerning this document and the product(s) described herein, have been included in section 'Legal information'.

© Ampleon The Netherlands B.V. 2015. All rights reserved.

For more information, please visit: <http://www.ampleon.com>  
 For sales office addresses, please visit: <http://www.ampleon.com/sales>

Date of release: 1 September 2015

Document identifier: BLF6G15L-40RN\_6G15LS-40RN#3