

3 Joining the Pipe to the Ceiling Adapter

IMPORTANT! Do not loosen screws all the way when making adjustments, this may disconnect the parts and may cause injury or property damage.

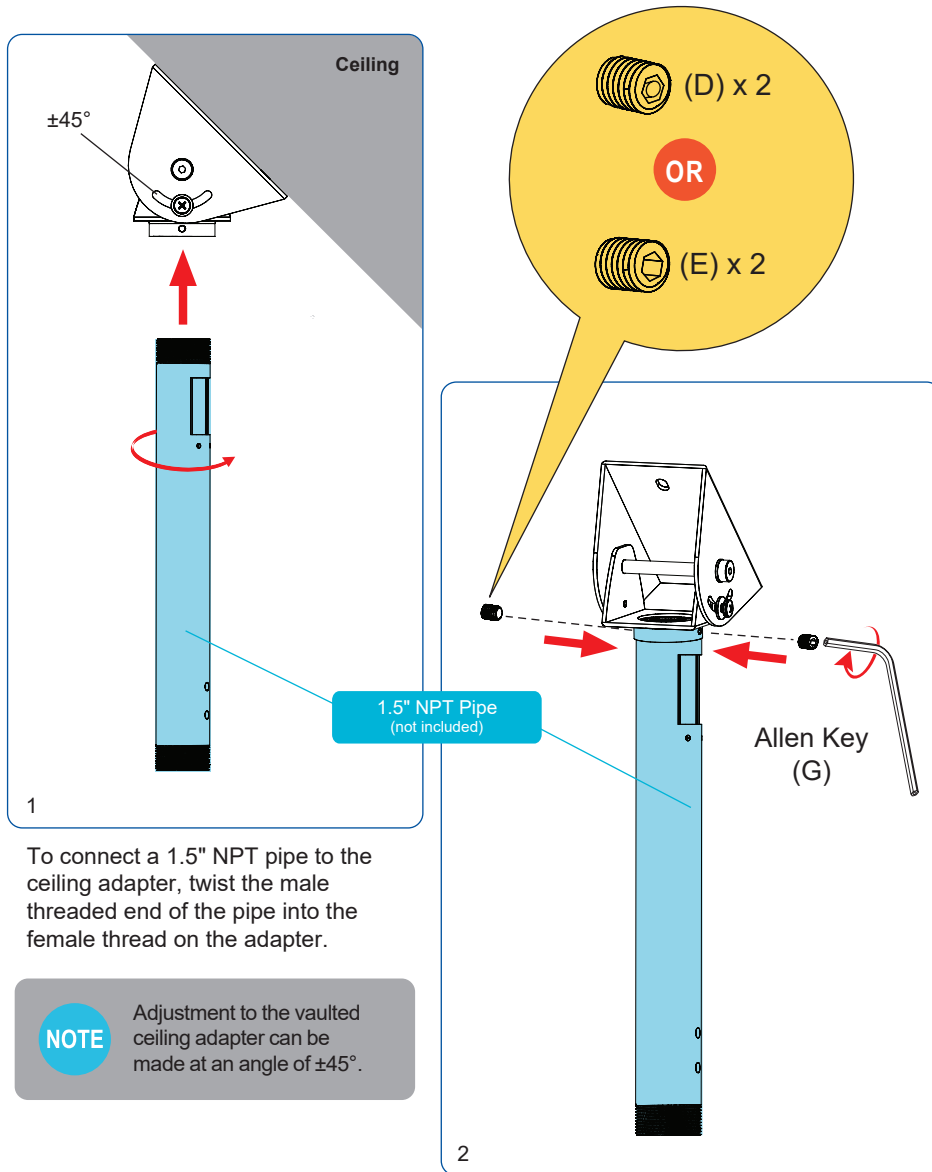

To connect a 1.5" NPT pipe to the ceiling adapter, twist the male threaded end of the pipe into the female thread on the adapter.

NOTE Adjustment to the vaulted ceiling adapter can be made at an angle of $\pm 45^\circ$.

Using allen key (G), tighten screws (D or E) onto the pipe and secure the position.

QualGear
Accessories that Inspire.

QG-PRO-PM-VCA-B
QG-PRO-PM-VCA-W
INSTALLATION MANUAL

VAULTED CEILING ADAPTER

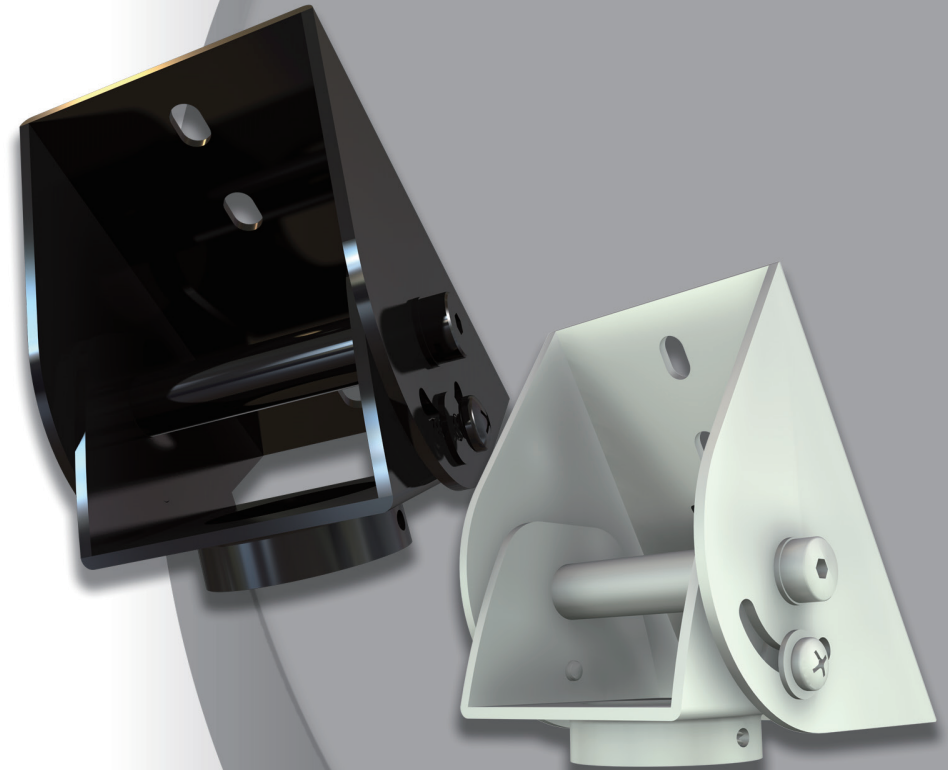

www.qualgear.com

136kg
(300lbs)
RATED

CAUTION!
Do not exceed the maximum rated weight specified. Otherwise, serious injury or property damage may occur.



■ 5 Year Limited Warranty

■ Version November 2015

NOTE Please read the entire installation manual before you start installation and assembly.

WARNING

- Do not begin to install your QualGear product until you have read and understood all the instructions and warnings contained in this installation manual. If you have any questions regarding the instructions, for US customers please contact QualGear customer support via email at support@qualgear.com. For all international customers, please contact your local distributor.
- This product should only be installed by someone of good mechanical aptitude, has experience with basic building construction, and fully understands these instructions.
- This product was designed to be installed and utilized only as specified in this manual. Improper installation of this product may cause damage or serious injury. QualGear is not liable for the improper use or installation of its products.
- Make sure that the supporting surface will safely support the combined load of the equipment and all attached hardware and components.
- Always use an assistant or mechanical lifting equipment to safely lift and position the equipment.
- Tighten screws firmly, but do not over tighten. Over tightening can damage the items, greatly reducing their holding power.
- ALL QUALGEAR products are intended for indoor use only and any outdoor use voids the limited warranty. For warranty information, please visit:
<http://www.qualgear.com/warranty.php>
- Never exceed the maximum rated weight specified in this manual.
- All hardware must be used at the designated points in the installation instructions to prevent property damage and/or personal injury.
- This product was designed to be compatible with all standard 1.5" NPT pipes.



IMPORTANT: Installers must verify that the supporting surface will safely support the combined weight of the equipment and all attached hardware and components.

Maintenance

Please check that the ceiling adapter is secure and safe to use at regular intervals. If you have any questions regarding any of the instructions or warnings, please contact your local distributor (OR) contact QualGear technical support via email at support@qualgear.com.

Parts & Hardware Checklist



IMPORTANT: Before starting installation, please check that all parts shown in this checklist are included. If any parts are missing or damaged, contact your local distributor or support@qualgear.com for replacement parts and do not start assembly and installation until you receive all the parts.

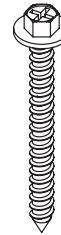

Screws
A (x3)



Wall Marking Template
B (x1)

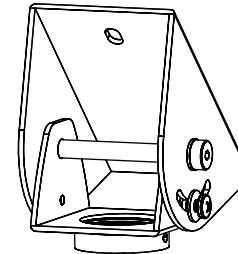

Vaulted Ceiling Adapter
C (x1)



M5 x 5mm Security Screws
D (x2)



M5 x 5mm Screws
E (x2)



Metal Expansion Anchors
F (x3)



Allen Key
G (x1)

1a Mounting to a Vaulted Wooden Joist or Wooden Stud Ceiling

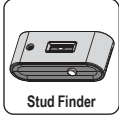
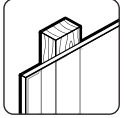

NOTE For concrete ceiling mounting, follow step 1b.

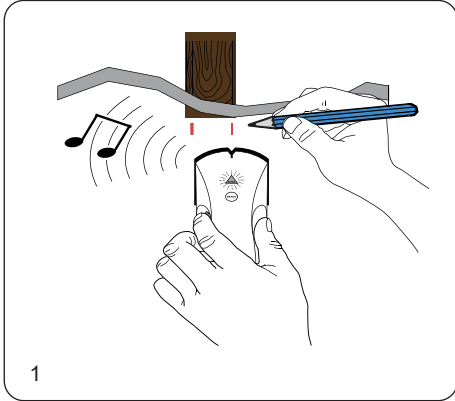

1

Using an edge-to-edge stud finder, find the edges of the stud.

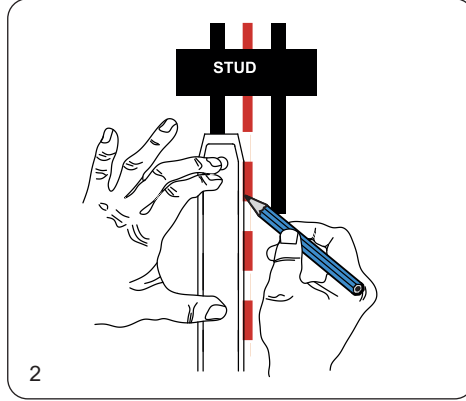

2

Using a straight edge, mark the centerline of the stud.

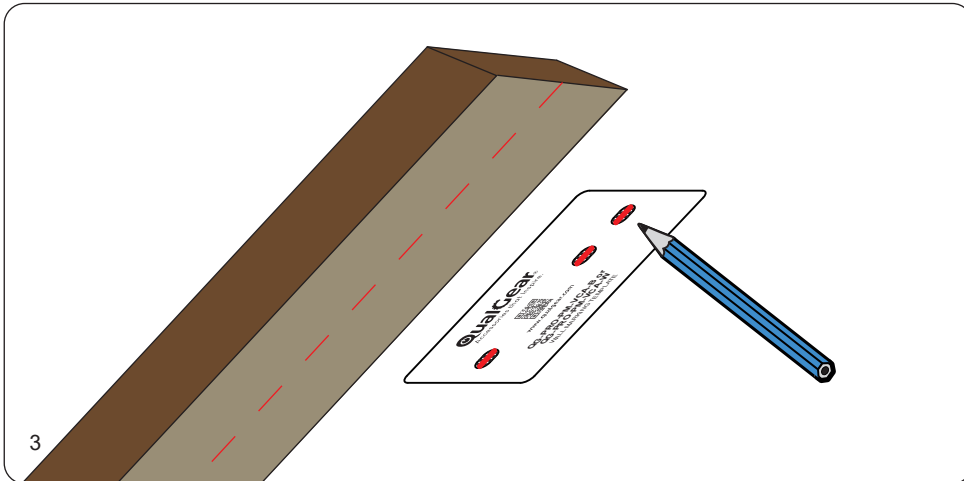

3

Using wall marking template (B), mark on the center of the stud the locations of where you want to mount the ceiling adapter.

TIP

Mark the drill locations on the center of the studs for security.

SKIP TO STEP 2 →

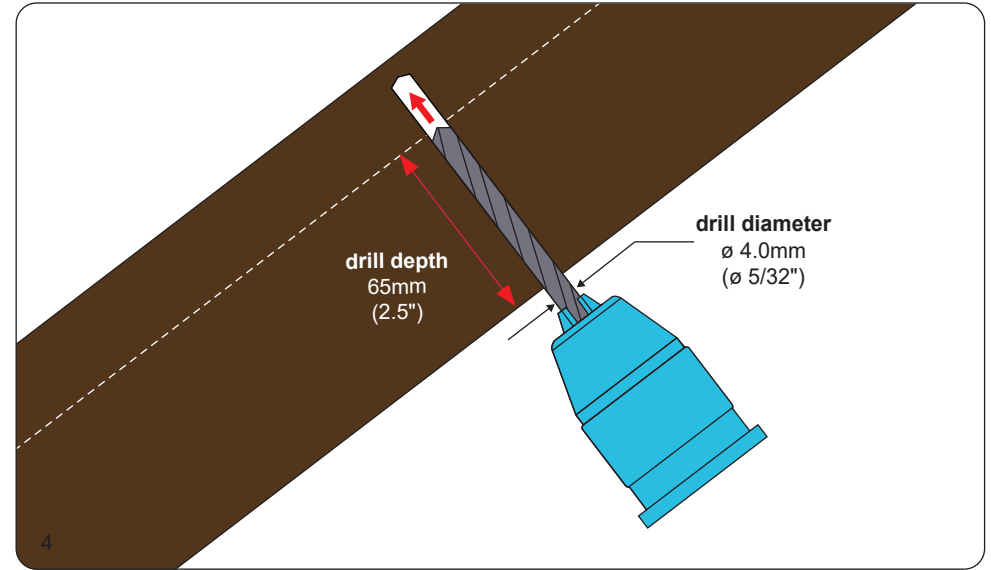

4

Using a power drill and a 5/32" wood drill bit, drill holes of 5/32" (4mm) diameter, and 2.5" (65mm) depth at the marked locations.

1b Mounting to a Vaulted Concrete Ceiling

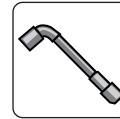
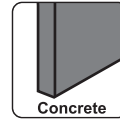

TIP

Make sure drilled holes are free of dust so the anchors will be set properly.

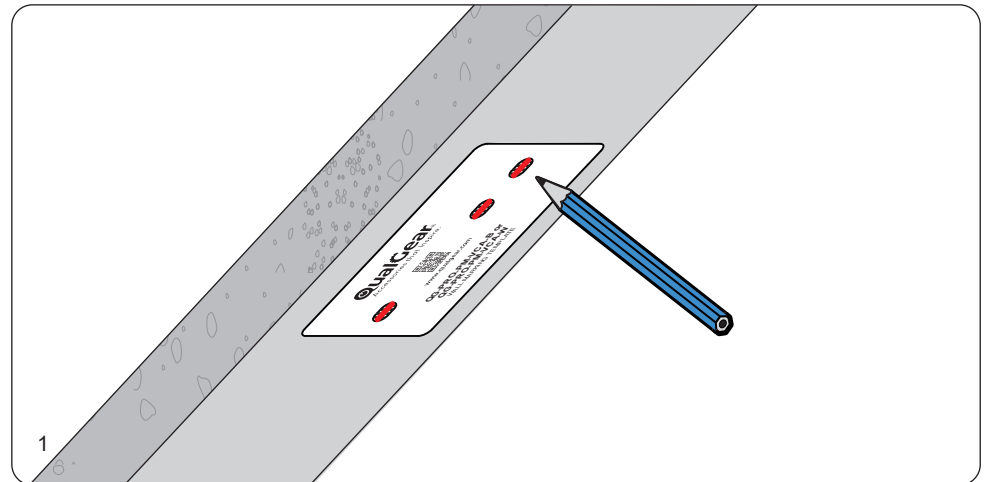

1

Using wall marking template (B), mark on the concrete the locations of where you want to mount the ceiling adapter.

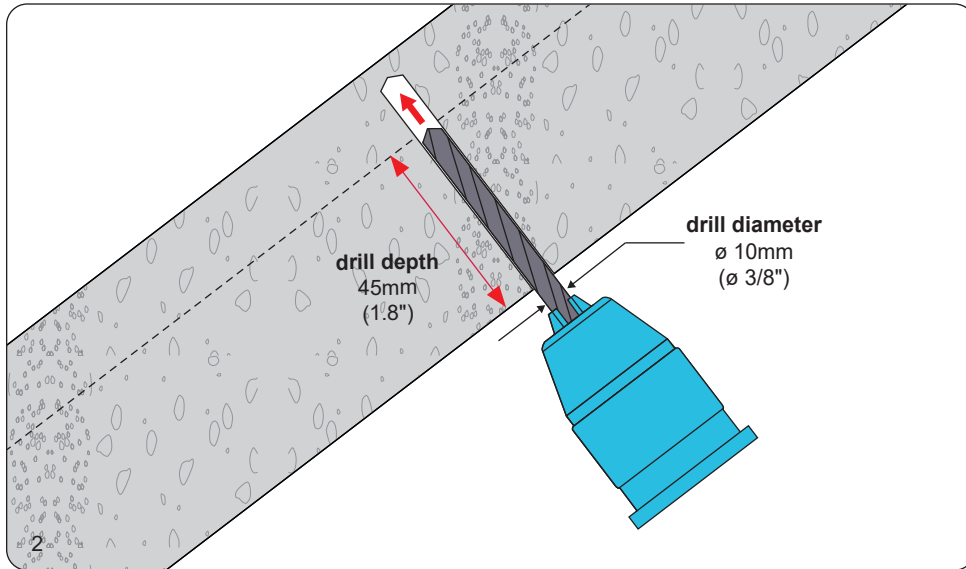

Using a power drill and a 3/8" masonry drill bit, drill mounting holes of 3/8" (10mm) diameter and 1.8" (45mm) depth at the marked locations in the previous step.

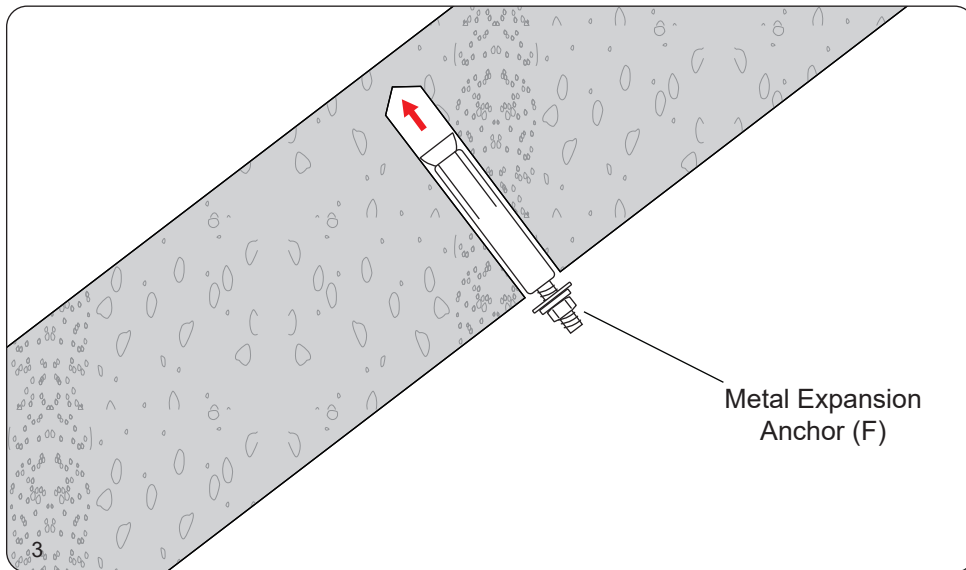

Insert the metal expansion anchors (F) and hammer them into the drilled holes. Make sure to leave a portion of the anchors outside of the concrete. Once the anchors are set, take off the washers and the nuts on the anchors by using a socket wrench.

2 Installing the Vaulted Ceiling Adapter to the Ceiling



WOODEN JOIST CEILING

Align the mounting holes on the vaulted ceiling adapter with the drilled holes on the ceiling, insert screws (A) into the mounting holes and tighten with a socket wrench.

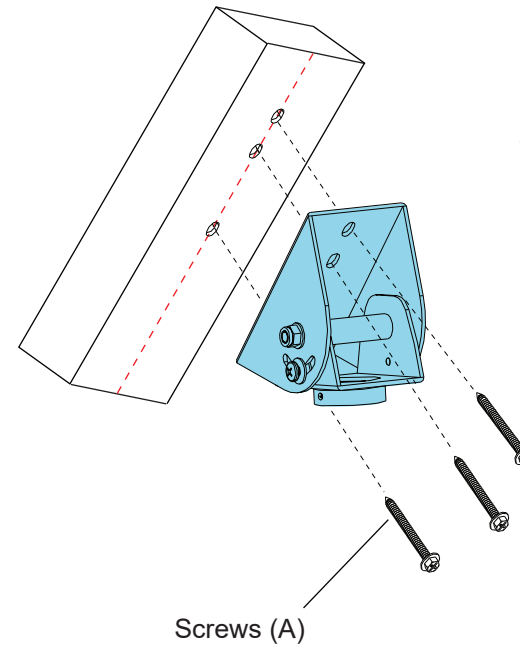

CONCRETE CEILING

After setting the metal expansion anchors (F) into the drilled holes, align them with the mounting holes on the vaulted ceiling adapter. Then place the washers and the nuts at the end of the anchors and tighten with a socket wrench.

