

GlobTek, Inc. www.globtek.com 186 Veterans Drive, Northvale, NJ 07647 Tel. (201) 784-1000 Fax (201) 784-0111	Drawing Title: GTM91110P24012-FA-S, Medical Power Supply, Efficiency Level: , Case Color/Style: PCB, Open Frame/Internal, Regulated Switchmode AC-DC Power Supply AC Adaptor, Input Rating: 100-240V~, 50-60 Hz, PCB Pins , Output Rating: 240W, 12V@20A, Output Configuration: N/A mm, N/A/6 Cond, , MOLEX 6-PIN FRICTION LOCK HEADER P/N 26-60-4060 MATES WITH PN: 09-50-3061, Ferrite: None, N/A, GT Cord # C1196, Pin Out: Pins 1,2,3: V+, Pins 4,5,6: Common, Blades/Input Cord: Not Applicable, Approvals: SIQ; SIQ; CE; cETLus 60601; cETLus; ETL; Class I; Book 60601; EAC; RoHS; China RoHS; FCC; Ukraine; VCCI; WEEE;	
	Model No. GTM91110P24012-FA-S	
	Part No./Ordering No. GTM91110P24012FSIM(R)	Rev C

REVISION HISTORY

REV	DESCRIPTION	SUB	DATE	APPROVED
C	Update to SF format, update approvals on the label		08/15/2018	QA

In Addition to GlobTek Inc.'s renewed ISO9001:2015 - Quality Management System Certification, GlobTek Inc. is now certified to:

ISO13485:2016 - Medical Devices Quality Management System Certification
ISO14001:2015 - Environmental Management System Certification

ISO Certificates are available online at <https://www.globtek.com/iso-certificates/>

Customer Approval of Specification:

Please approve, sign and send back to GlobTek so we can complete order processing.
A delay in receipt of this form will delay delivery schedule.

Company Name:

Customer P/N:

Quote Number:

Date:

Authorized Representative Name:

Authorized Representative Signature:

The acceptance of this specification and use of the product described in this document indicates the acceptance and binding of the customer to Globtek terms and conditions, which supersede all other agreements, terms, and conditions (<https://en.globtek.com/terms-and-conditions/>).

Footnote:

GlobTek Inc. will not be liable for the safety and performance of these power supplies if unauthorized access and repair occurs. End user should consult applicable UL, CSA or EN standards for proper installation instruction.

Limitation of Use:

GlobTek products are intended for use with commercial, medical, and/or industrial equipment only. GlobTek product are not authorized for use as mission critical components in life support hazardous environment, nuclear or aircraft applications without prior written approval from the CEO of GlobTek Inc.
Contents of this document are subject to change without prior notice.

GlobTek, Inc. www.globtek.com 186 Veterans Drive, Northvale, NJ 07647 Tel. (201) 784-1000 Fax (201) 784-0111	Drawing Title: GTM91110P24012-FA-S, Medical Power Supply, Efficiency Level: , Case Color/Style: PCB, Open Frame/Internal, Regulated Switchmode AC-DC Power Supply AC Adaptor, Input Rating: 100-240V~, 50-60 Hz, PCB Pins , Output Rating: 240W, 12V@20A, Output Configuration: N/A mm, N/A/6 Cond, , MOLEX 6-PIN FRICTION LOCK HEADER P/N 26-60-4060 MATES WITH PN: 09-50-3061, Ferrite: None, N/A, GT Cord # C1196, Pin Out: Pins 1,2,3: V+, Pins 4,5,6: Common, Blades/Input Cord: Not Applicable, Approvals: SIQ; SIQ; CE; cETLus 60601; cETLus; ETL; Class I; Book 60601; EAC; RoHS; China RoHS; FCC; Ukraine; VCCI; WEEE;	
	Model No. GTM91110P24012-FA-S	
	Part No./Ordering No. GTM91110P24012FSIM(R)	Rev C

POWER SUPPLY INFORMATION

TYPE: Open Frame/Internal
TECHNOLOGY: Regulated Switchmode AC-DC Power Supply AC Adaptor
CASE COLOR: PCB
NAMEPLATE RATED INPUT: 100-240V~, 50-60 Hz, 4.0
INPUT CONFIG: PCB Pins
WATTS: 240.0
VOLTS OUT: 12
CURRENT OUT (Amps): 20
BLADE/CORD INCLUDED: N/A
BLADE/CORD INSTALLED: N/A
INGRESS PROTECTION:
GROUNDING CONFIGURATION: (E1) Earthed output
OUTPUT CONFIGURATION: N/A mm, N/A/6 Cond, , MOLEX 6-PIN FRICTION LOCK HEADER P/N 26-60-4060 MATES WITH PN: 09-50-3061, Ferrite: None, N/A, GT Cord # C1196
CONNECTOR PIN OUT: Pins 1,2,3: V+, Pins 4,5,6: Common
LABEL SPECS: Standard GT,L-1186
SPECIAL BARCODE LABEL
MATERIAL:
PACK SPEC: Standard OF, Individually Box
USER MANUAL: N/A User Manual

Notes/Modifications/Customizations (notes in this section supersede the values shown in the standard spec):

DIMENSIONS ARE IN MM UNLESS SPECIFIED OTHERWISE.

GlobTek, Inc. www.globtek.com 186 Veterans Drive, Northvale, NJ 07647 Tel. (201) 784-1000 Fax (201) 784-0111	Drawing Title: GTM91110P24012-FA-S, Medical Power Supply, Efficiency Level: , Case Color/Style: PCB, Open Frame/Internal, Regulated Switchmode AC-DC Power Supply AC Adaptor, Input Rating: 100-240V~, 50-60 Hz, PCB Pins , Output Rating: 240W, 12V@20A, Output Configuration: N/A mm, N/A/6 Cond, , MOLEX 6-PIN FRICTION LOCK HEADER P/N 26-60-4060 MATES WITH PN: 09-50-3061, Ferrite: None, N/A, GT Cord # C1196, Pin Out: Pins 1,2,3: V+, Pins 4,5,6: Common, Blades/Input Cord: Not Applicable, Approvals: SIQ; SIQ; CE; cETLus 60601; cETLus; ETL; Class I; Book 60601; EAC; RoHS; China RoHS; FCC; Ukraine; VCCI; WEEE;	
	Model No. GTM91110P24012-FA-S	
	Part No./Ordering No. GTM91110P24012FSIM(R)	Rev C

ELECTRICAL SPECIFICATIONS

A) ELECTRICAL SPECIFICATIONS:

01. Input Voltage: Specified 90-264 Vac, Nameplate rated 100-240 Vac
02. Input Frequency: Specified 47-63 Hz, Nameplate rated 50/60 Hz
03. Inrush current: Cold start @ 25°C, 40A @ 115Vac, 80A @ 230Vac
04. Efficiency: 85% to 90% typical at full load, 120-240Vac input
05. Power factor: 0.98 typical at full load, 230Vac input
06. Turn on delay: 5 Seconds maximum, (3 seconds max option)
07. Load regulation: $\pm 1\%$ Measured at the connector side
08. Line regulation: $\pm 0.2\%$ Measured at the connector side
09. Output Ripple protection (Peak to Peak): $\pm 1\%$ maximum of nominal output voltage measured at 20 MHz bandwidth with 0.1 μ f ceramic capacitor in parallel with a low impedance 47 μ f electrolytic capacitor located 200mm from the end of the output connector
10. Turn on/off overshoot: 5% Maximum, 1mS recovery time
11. Hold up time: 8 mS @ 300W load, 10mS@200W load, 16mS@150W load at 115Vac input
12. Transient response: 2% Maximum deviation, returns to initial condition in 3 ms max for 25% load step, from 10% to 100% of rated load
13. Remote sense (optional): compensates for up to 0.5V voltage drop in output wiring.
Power supply will operate correctly, with or without remote sense pins hooked up.
14. Auxillary Output: For forced air fan 12V @ 250mA, if convection cooled 12V @ 150mA. Other output voltages and current ratings from 5V to 24V available, contact factory for availability.
15. Indicator: Green LED for output presence

B) PROTECTION

01. Input Protection: Input line fusing and 300Vac MOV
02. Short circuit: Protected. Unit will autorecover upon removal of short
03. Overload protection: Autorecover upon removal of overload
 - 150W, 175% - 210% of nominal power rating
 - 200W, 130% - 160% of nominal power rating
 - 240W, 110% - 130% of nominal power rating
 - 300W, 110% - 130% of nominal power rating
04. Over voltage: Protected at 110- 140% of nominal output voltage, latched type. AC cycling required to restore output. Autorecovery type OVP is an option, contact factory for availability.
05. Fan output protection: 3 Pin Linear Regulator, short circuit proof

C) SAFETY

01. Dielectric Withstand Voltage: 4000Vac or 5656Vdc from input to output,
On Class I models, 2500Vac or 3535Vdc from input to earth
02. Earth Leakage Current:
 - Class I Input Models: Does not exceed 500uA
 - Class II Input Models: Does not apply
03. Touch Current: Does not exceed 100uA, output terminations to earth
04. Output terminations rated as SELV, and Means of Operator Protection

D) OTHER:

01. MTBF: 200,000 Hours @ 25°C ambient temperature
02. Operating Temperature Range:
 - 10°C to 50°C @ 100% output power rating

PROPRIETARY INFORMATION

PROPRIETARY OF GLOBTEK, INC. ANY REPRODUCTION, DISCLOSURE OR USE OF THIS DRAWING, IN WHOLE OR IN PART, IS HEREBY PROHIBITED EXCEPT AS SPECIFIED IN WRITING BY GLOBTEK, INC. © GlobTek, Inc. 2012 - 2019

GlobTek, Inc. www.globtek.com 186 Veterans Drive, Northvale, NJ 07647 Tel. (201) 784-1000 Fax (201) 784-0111	Drawing Title: GTM91110P24012-FA-S, Medical Power Supply, Efficiency Level: , Case Color/Style: PCB, Open Frame/Internal, Regulated Switchmode AC-DC Power Supply AC Adaptor, Input Rating: 100-240V~, 50-60 Hz, PCB Pins , Output Rating: 240W, 12V@20A, Output Configuration: N/A mm, N/A/6 Cond, , MOLEX 6-PIN FRICTION LOCK HEADER P/N 26-60-4060 MATES WITH PN: 09-50-3061, Ferrite: None, N/A, GT Cord # C1196, Pin Out: Pins 1,2,3: V+, Pins 4,5,6: Common, Blades/Input Cord: Not Applicable, Approvals: SIQ; SIQ; CE; cETLus 60601; cETLus; ETL; Class I; Book 60601; EAC; RoHS; China RoHS; FCC; Ukraine; VCCI; WEEE;	
	Model No. GTM91110P24012-FA-S	
	Part No./Ordering No. GTM91110P24012FSIM(R)	Rev C

-10°C to 70°C @ 50% output power derating

03. Cooling:

Open Frame 150W Series: Convection

Open Frame 240W and 300W Series: 20 CFM Forced Air Cooling

Perforated Plastic Housing 200W Series: 20 CFM Forced Air Cooling,
with convection cooling 50% derated (100W) output capability.

04. Relative Humidity: operating 0% to 90% Non-condensing

05. Storage Temperature: -30°C to 85°C

06. Altitude: up to 2000 meter

07. Random vibration/transient drop: MIL-STD 810E

E) MECHANICAL FORMAT:

150W, 240W and 300W Open Frame version

Size: 127*76.2*43 mm

Weight: 470 grams

200W Perforated Plastic Enclosure version

Size: 140*87.6*51.9 mm

Weight: 620 grams

GlobTek, Inc. www.globtek.com 186 Veterans Drive, Northvale, NJ 07647 Tel. (201) 784-1000 Fax (201) 784-0111	Drawing Title: GTM91110P24012-FA-S, Medical Power Supply, Efficiency Level: , Case Color/Style: PCB, Open Frame/Internal, Regulated Switchmode AC-DC Power Supply AC Adaptor, Input Rating: 100-240V~, 50-60 Hz, PCB Pins , Output Rating: 240W, 12V@20A, Output Configuration: N/A mm, N/A/6 Cond, , MOLEX 6-PIN FRICTION LOCK HEADER P/N 26-60-4060 MATES WITH PN: 09-50-3061, Ferrite: None, N/A, GT Cord # C1196, Pin Out: Pins 1,2,3: V+, Pins 4,5,6: Common, Blades/Input Cord: Not Applicable, Approvals: SIQ; SIQ; CE; cETLus 60601; cETLus; ETL; Class I; Book 60601; EAC; RoHS; China RoHS; FCC; Ukraine; VCCI; WEEE;	
	Model No. GTM91110P24012-FA-S	
	Part No./Ordering No. GTM91110P24012FSIM(R)	Rev C

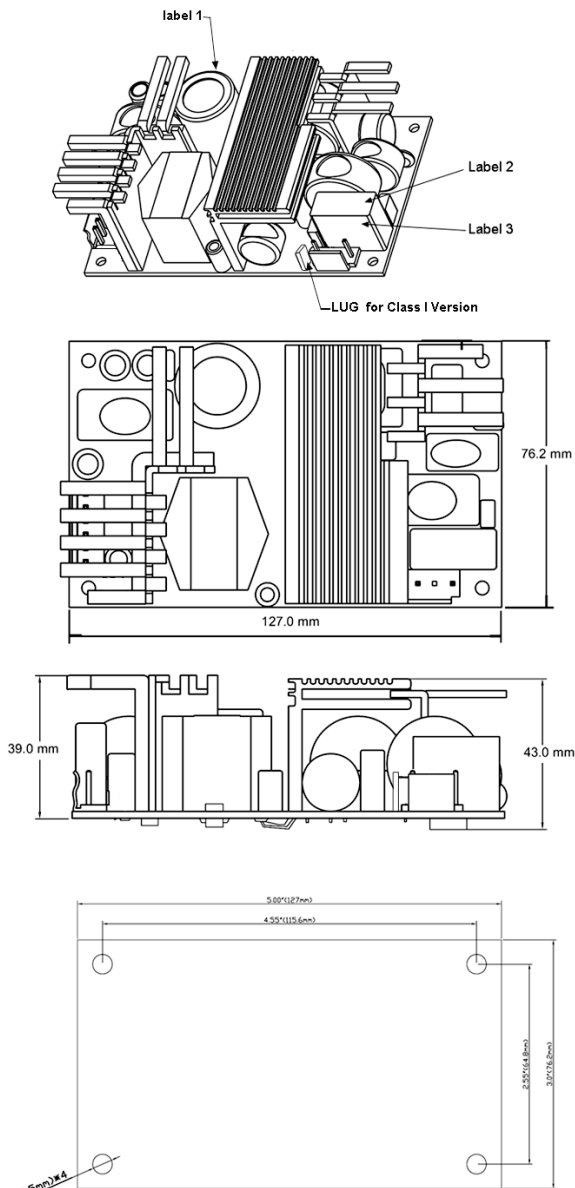

MOUNTING REQUIREMENTS:
 USE ONLY M3 TYPE SCREWS AND STANDOFF FOR MOUNTING.
 HARDWARES BIGGER THAN M3 TYPE MAY CAUSE SPACING VIOLATION BETWEEN LIVE PARTS AND THE CHASSIS.

DERATING CURVE

GlobTek, Inc. www.globtek.com 186 Veterans Drive, Northvale, NJ 07647 Tel. (201) 784-1000 Fax (201) 784-0111	Drawing Title: GTM91110P24012-FA-S, Medical Power Supply, Efficiency Level: , Case Color/Style: PCB, Open Frame/Internal, Regulated Switchmode AC-DC Power Supply AC Adaptor, Input Rating: 100-240V~, 50-60 Hz, PCB Pins , Output Rating: 240W, 12V@20A, Output Configuration: N/A mm, N/A/6 Cond, , MOLEX 6-PIN FRICTION LOCK HEADER P/N 26-60-4060 MATES WITH PN: 09-50-3061, Ferrite: None, N/A, GT Cord # C1196, Pin Out: Pins 1,2,3: V+, Pins 4,5,6: Common, Blades/Input Cord: Not Applicable, Approvals: SIQ; SIQ; CE; cETLus 60601; cETLus; ETL; Class I; Book 60601; EAC; RoHS; China RoHS; FCC; Ukraine; VCCI; WEEE;	
	Model No. GTM91110P24012-FA-S	
	Part No./Ordering No. GTM91110P24012FSIM(R)	Rev C

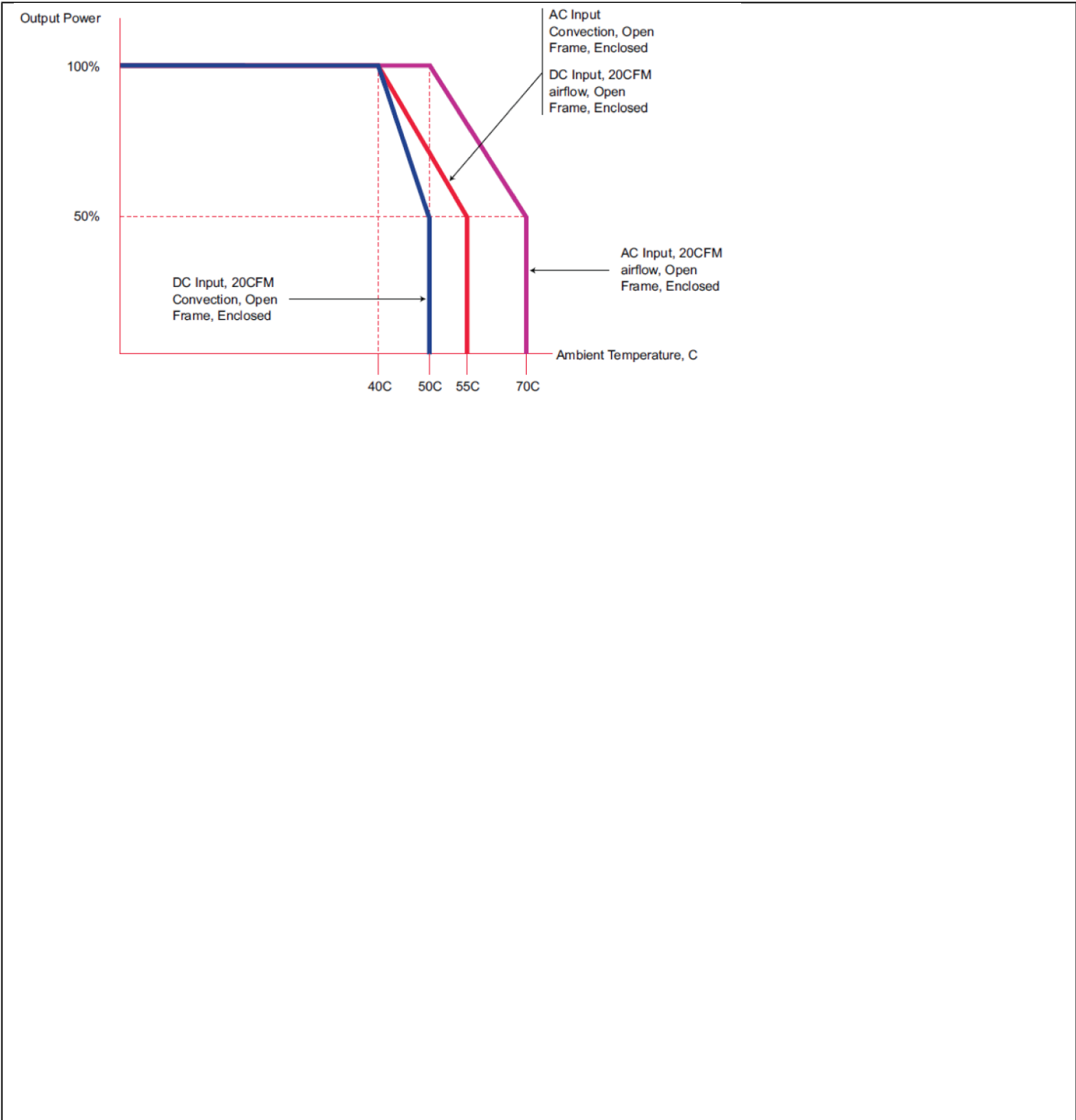

GlobTek, Inc. www.globtek.com 186 Veterans Drive, Northvale, NJ 07647 Tel. (201) 784-1000 Fax (201) 784-0111	Drawing Title: GTM91110P24012-FA-S, Medical Power Supply, Efficiency Level: , Case Color/Style: PCB, Open Frame/Internal, Regulated Switchmode AC-DC Power Supply AC Adaptor, Input Rating: 100-240V~, 50-60 Hz, PCB Pins , Output Rating: 240W, 12V@20A, Output Configuration: N/A mm, N/A/6 Cond, , MOLEX 6-PIN FRICTION LOCK HEADER P/N 26-60-4060 MATES WITH PN: 09-50-3061, Ferrite: None, N/A, GT Cord # C1196, Pin Out: Pins 1,2,3: V+, Pins 4,5,6: Common, Blades/Input Cord: Not Applicable, Approvals: SIQ; SIQ; CE; cETLus 60601; cETLus; ETL; Class I; Book 60601; EAC; RoHS; China RoHS; FCC; Ukraine; VCCI; WEEE;	
	Model No. GTM91110P24012-FA-S	
	Part No./Ordering No. GTM91110P24012FSIM(R)	Rev C

INPUT CONFIGURATION

(E1) Earthed output

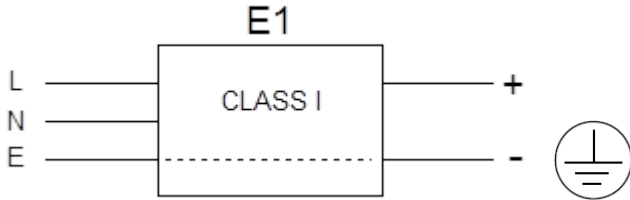

[Alternate grounding configurations](#) available upon request.

Blades/Cord Included:N/A:

Blades/Cord Installed:N/A:

Molex 26-60-4050 5 Position Header Pin 1: Gnd, Pin 2: Removed, PIN 3: Neutral, Pin 4: removed, Pin 5: Line

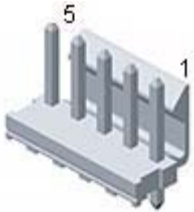

Optional Input Wiring Kits are available:

PN/Ordering No	Length	End A	End B
C810070M6MLX5(R)	60	IEC 60320 C8	MOLEX 09-50-3051
C1410070M6MLX5(R)	60	IEC 60320 C13	MOLEX 09-50-3051
MLX5410070M7MLX5(R)	73	MOLEX 09-50-3051	MOLEX 09-50-3051

Custom lengths, construction, cable types, ferrites, filters, and termination available upon request.

GlobTek, Inc. www.globtek.com 186 Veterans Drive, Northvale, NJ 07647 Tel. (201) 784-1000 Fax (201) 784-0111	Drawing Title: GTM91110P24012-FA-S, Medical Power Supply, Efficiency Level: , Case Color/Style: PCB, Open Frame/Internal, Regulated Switchmode AC-DC Power Supply AC Adaptor, Input Rating: 100-240V~, 50-60 Hz, PCB Pins , Output Rating: 240W, 12V@20A, Output Configuration: N/A mm, N/A/6 Cond, , MOLEX 6-PIN FRICTION LOCK HEADER P/N 26-60-4060 MATES WITH PN: 09-50-3061, Ferrite: None, N/A, GT Cord # C1196, Pin Out: Pins 1,2,3: V+, Pins 4,5,6: Common, Blades/Input Cord: Not Applicable, Approvals: SIQ; SIQ; CE; cETLus 60601; cETLus; ETL; Class I; Book 60601; EAC; RoHS; China RoHS; FCC; Ukraine; VCCI; WEEE;	
	Model No. GTM91110P24012-FA-S	
	Part No./Ordering No. GTM91110P24012FSIM(R)	Rev C

OUTPUT CORD AND CONNECTOR: MOLFC1196

ACTUAL CONNECTORS, OVERMOLDS, FERRITES MAY VARY SLIGHTLY FROM THE PICTURE BELOW

CABLE TYPE

CABLE LENGTH (mm) N/A

CABLE TOLERANCE (mm) N/A

WIRE GAUGE (AWG) N/A

CONDUCTORS 6

HANK DIMENSION (mm) N/A

CABLE / CONNECTOR OVERMOLD COLOR N/A

FERRITE TYPE / DIMENSION None

FERRITE # OF TURNS [\(Definition\)](#) N/A

FERRITE DIMENSION FROM STRAIN RELIEF N/A

FERRITE DIMENSION FROM PLUG N/A

PLUG TYPE MOLEX 6-PIN FRICTION LOCK HEADER P/N 26-60-4060 MATES WITH PN: 09-50-3061

OUTPUT CONNECTOR SEX

OVERMOLDED

OVER MOLD ORIENTATION

CONNECTOR PIN OUT: Pins 1,2,3: V+, Pins 4,5,6: Common

ADDITIONAL REQUIREMENTS

Drawing: http://www.molex.com/pdm_docs/sd/022280040_sd.pdf

Datasheet: http://www.molex.com/molex/products/datasheet.jsp?part=active/0022280040_PCB_HEADERS.xml

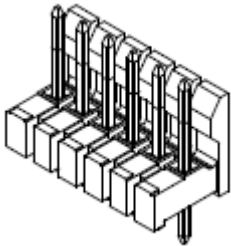

Mates With Part(s):

[KK® Crimp Housing 2695, 6471, 7880](#), [KK® PC Board Connector 4455](#)

ADDITIONAL OUTPUT PLUG OPTIONS ARE AVAILABLE AT <https://www.globtek.com/connectors/>

STANDARD PLUGS AND CONNECTORS CAN BE SEEN ONLINE AT <https://www.globtek.com/connectors/>

GlobTek, Inc. www.globtek.com 186 Veterans Drive, Northvale, NJ 07647 Tel. (201) 784-1000 Fax (201) 784-0111	Drawing Title: GTM91110P24012-FA-S, Medical Power Supply, Efficiency Level: , Case Color/Style: PCB, Open Frame/Internal, Regulated Switchmode AC-DC Power Supply AC Adaptor, Input Rating: 100-240V~, 50-60 Hz, PCB Pins , Output Rating: 240W, 12V@20A, Output Configuration: N/A mm, N/A/6 Cond, , MOLEX 6-PIN FRICTION LOCK HEADER P/N 26-60-4060 MATES WITH PN: 09-50-3061, Ferrite: None, N/A, GT Cord # C1196, Pin Out: Pins 1,2,3: V+, Pins 4,5,6: Common, Blades/Input Cord: Not Applicable, Approvals: SIQ; SIQ; CE; cETLus 60601; cETLus; ETL; Class I; Book 60601; EAC; RoHS; China RoHS; FCC; Ukraine; VCCI; WEEE;	
	Model No. GTM91110P24012-FA-S	
	Part No./Ordering No. GTM91110P24012FSIM(R)	Rev C

LABEL:L-1186

LABEL P/N: Standard GT

MATERIAL: Flat Thermal Transfer, Imprintable, Polyester Label and/or Pad Printed and/or Molded, and/or Laser Engraved in the case

BACKGROUND COLOR: Black if housing is Black, White or Silver if housing is White or Gray.

TEXT COLOR: White or Silver if label is Black Background for Black housing. Black if label is White or Silver background and Housing is White or Gray

LABEL WIDTH (mm): 30.0

LABEL HEIGHT (mm): 20.0

SPECIAL BARCODE LABEL MATERIAL:

Below is the minimum information which will appear on the label. NOTE: in the logo area additional/actual positioning of symbols and text is subjected to change as per agency updates/requirements or additional model approvals become available.

Regulatory certifications/label markings may be in logo area on the label or molded into the case housing outside the label area.

Information will be shown via label and/or pad printed and/or molded and/or laser engraved in the case. * Date code markings at GlobTek option.



A=Medical Power Supply
B=P/N: (料号) GTM91110P24012FSIM(R)
C=Model (型号) GTM91110P24012-FA-S
D=Input (输入) 100-240V~, 50-60 Hz, 4.0
E=Output (输出) 12 V 20 A, 240.0W

GlobTek, Inc. www.globtek.com 186 Veterans Drive, Northvale, NJ 07647 Tel. (201) 784-1000 Fax (201) 784-0111	Drawing Title: GTM91110P24012-FA-S, Medical Power Supply, Efficiency Level: , Case Color/Style: PCB, Open Frame/Internal, Regulated Switchmode AC-DC Power Supply AC Adaptor, Input Rating: 100-240V~, 50-60 Hz, PCB Pins , Output Rating: 240W, 12V@20A, Output Configuration: N/A mm, N/A/6 Cond, , MOLEX 6-PIN FRICTION LOCK HEADER P/N 26-60-4060 MATES WITH PN: 09-50-3061, Ferrite: None, N/A, GT Cord # C1196, Pin Out: Pins 1,2,3: V+, Pins 4,5,6: Common, Blades/Input Cord: Not Applicable, Approvals: SIQ; SIQ; CE; cETLus 60601; cETLus; ETL; Class I; Book 60601; EAC; RoHS; China RoHS; FCC; Ukraine; VCCI; WEEE;	
	Model No. GTM91110P24012-FA-S	
	Part No./Ordering No. GTM91110P24012FSIM(R)	Rev C

AGENCY ONLINE DOCUMENTS

- CE EC-Declaration for Medical http://globtek.force.com/models/ec_declaration?id=a0Oa000000Bz790EAB
 - CE EC-Declaration for Industrial/Commercial/ITE [Contact GlobTek for more information](#)
 - CE EC-Declaration for Household [Contact GlobTek for more information](#)
 - RoHS/RoHS3 Declaration https://www.globtek.com/pdf/rohs_cert/01t30000002p7QKAAY
 - REACH Declaration https://www.globtek.com/pdf/iso_certificates/REACH.pdf
 - Conflict Minerals Declaration <https://www.globtek.com/pdf/conflict-minerals.pdf>
- IPXY rating is based on 3rd party testing and customers should check suitability and test system level IPXY rating before ordering.

Regulatory Certifications/Label Markings

LATEST PRODUCT/MODEL CERTIFICATIONS: <http://en.globtek.com/datasheet/id/a0Oa000000Bz790>
AGENCY ONLINE DOCUMENTS: <http://www.globtek.info/certs/GTM91110P/>



(E1) Earthed output

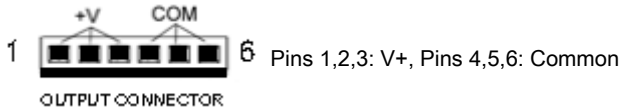

GlobTek, Inc. www.globtek.com 186 Veterans Drive, Northvale, NJ 07647 Tel. (201) 784-1000 Fax (201) 784-0111	Drawing Title: GTM91110P24012-FA-S, Medical Power Supply, Efficiency Level: , Case Color/Style: PCB, Open Frame/Internal, Regulated Switchmode AC-DC Power Supply AC Adaptor, Input Rating: 100-240V~, 50-60 Hz, PCB Pins , Output Rating: 240W, 12V@20A, Output Configuration: N/A mm, N/A/6 Cond, , MOLEX 6-PIN FRICTION LOCK HEADER P/N 26-60-4060 MATES WITH PN: 09-50-3061, Ferrite: None, N/A, GT Cord # C1196, Pin Out: Pins 1,2,3: V+, Pins 4,5,6: Common, Blades/Input Cord: Not Applicable, Approvals: SIQ; SIQ; CE; cETLus 60601; cETLus; ETL; Class I; Book 60601; EAC; RoHS; China RoHS; FCC; Ukraine; VCCI; WEEE;	
	Model No. GTM91110P24012-FA-S	
	Part No./Ordering No. GTM91110P24012FSIM(R)	Rev C

PACKAGING

Packing Spec P/N:	Standard OF, Individually Box
Box Qty:	60
Gift Box Size (mm):	135 x 85 x 60
Gift Box Color:	White
Master Carton Size (mm):	430 x 380 x 275
Master Carton Cubic Volume (m ³):	0.04
Master GW (Kg):	kg
BLADES INCLUDED:	N/A:
BLADE/CORD INSTALLED:	N/A:
USER MANUAL:	N/A User Manual
USER MANUAL WEB LINK:	

<p>GlobTek, Inc. www.globtek.com 186 Veterans Drive, Northvale, NJ 07647 Tel. (201) 784-1000 Fax (201) 784-0111</p>	<p>Drawing Title: GTM91110P24012-FA-S, Medical Power Supply, Efficiency Level: , Case Color/Style: PCB, Open Frame/Internal, Regulated Switchmode AC-DC Power Supply AC Adaptor, Input Rating: 100-240V~, 50-60 Hz, PCB Pins , Output Rating: 240W, 12V@20A, Output Configuration: N/A mm, N/A/6 Cond, , MOLEX 6-PIN FRICTION LOCK HEADER P/N 26-60-4060 MATES WITH PN: 09-50-3061, Ferrite: None, N/A, GT Cord # C1196, Pin Out: Pins 1,2,3: V+, Pins 4,5,6: Common, Blades/Input Cord: Not Applicable, Approvals: SIQ; SIQ; CE; cETLus 60601; cETLus; ETL; Class I; Book 60601; EAC; RoHS; China RoHS; FCC; Ukraine; VCCI; WEEE;</p>
	<p>Model No. GTM91110P24012-FA-S</p>
	<p>Part No./Ordering No. GTM91110P24012FSIM(R) Rev C</p>

If specific packaging is required, this section must specify all requirements and note "no exceptions". If this section does not specify packaging, it is subject to change without notice at GlobTek's discretion
(Power Supply in picture for reference only)

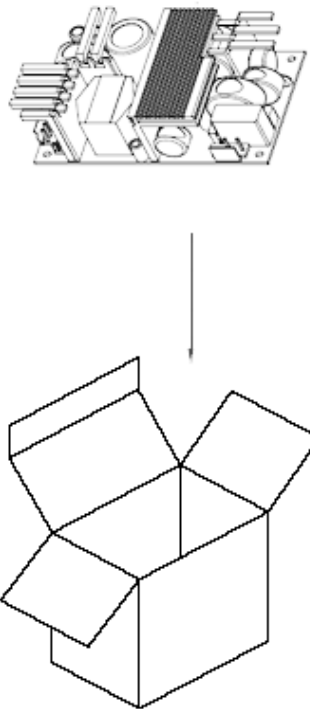
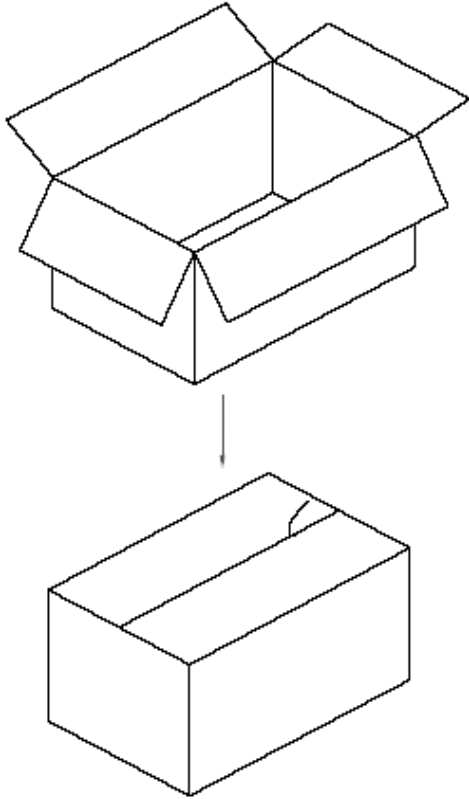

GlobTek, Inc. www.globtek.com 186 Veterans Drive, Northvale, NJ 07647 Tel. (201) 784-1000 Fax (201) 784-0111	Drawing Title: GTM91110P24012-FA-S, Medical Power Supply, Efficiency Level: , Case Color/Style: PCB, Open Frame/Internal, Regulated Switchmode AC-DC Power Supply AC Adaptor, Input Rating: 100-240V~, 50-60 Hz, PCB Pins , Output Rating: 240W, 12V@20A, Output Configuration: N/A mm, N/A/6 Cond, , MOLEX 6-PIN FRICTION LOCK HEADER P/N 26-60-4060 MATES WITH PN: 09-50-3061, Ferrite: None, N/A, GT Cord # C1196, Pin Out: Pins 1,2,3: V+, Pins 4,5,6: Common, Blades/Input Cord: Not Applicable, Approvals: SIQ; SIQ; CE; cETLus 60601; cETLus; ETL; Class I; Book 60601; EAC; RoHS; China RoHS; FCC; Ukraine; VCCI; WEEE;	
	Model No. GTM91110P24012-FA-S	
	Part No./Ordering No. GTM91110P24012FSIM(R)	Rev C

INSTRUCTIONS TO THE OEM SYSTEMS ENGINEER

It is the responsibility of the OEM systems engineer to provide the end system user instructions and warnings for the use of this product in the end system.

If an input cord is required for this product, AC Mains voltage should be provided to the power supply by a power supply cord approved to the national standards of the country in which it will be used.

This power supply is not designed to be repaired. No serviceable parts inside. A blown internal fuse is an indication of catastrophic failure of circuit component(s). If a Failure Analysis is required for a failed power supply/battery charger, please return the damaged unit to Globtek for an accurate determination of the root cause of the failure.

EMC Compliance of the complete OEM product, including the GlobTek power supply/battery charger needs to be verified by the OEM systems engineer.

INSTRUCTION SHEET