

Common mode Noise Filters

Type: **EXCX4CE**



Features

- Small and thin (L 0.65 mm×W 0.50 mm×H 0.30 mm)
- Noise suppression of high-speed differential transmission lines with little influence of waveform rounding on signal transmission
- Strong multilayer/sintered structure, excellent reflow resistance and high mounting reliability
- Lead, halogen and antimony-free
- RoHS compliant

Recommended Applications

- Smartphones, Tablet PCs and DSC
- Noise suppression of high-speed differential data lines such as MIPI, USB and LVDS

Explanation of Part Numbers

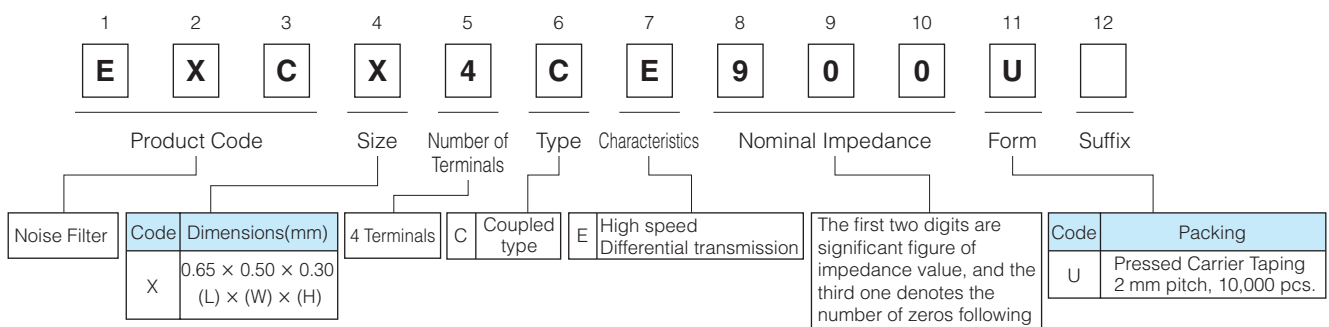

Construction

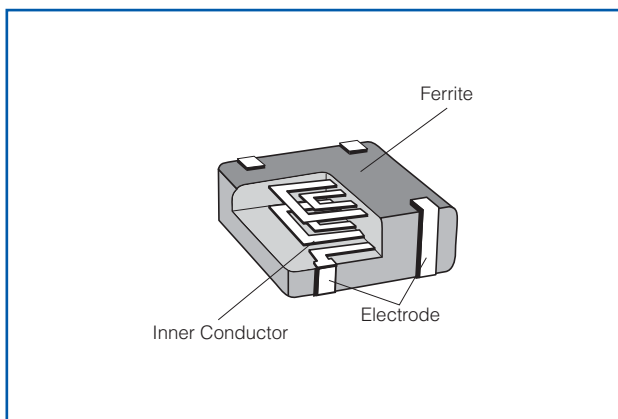

Dimensions in mm (not to scale)

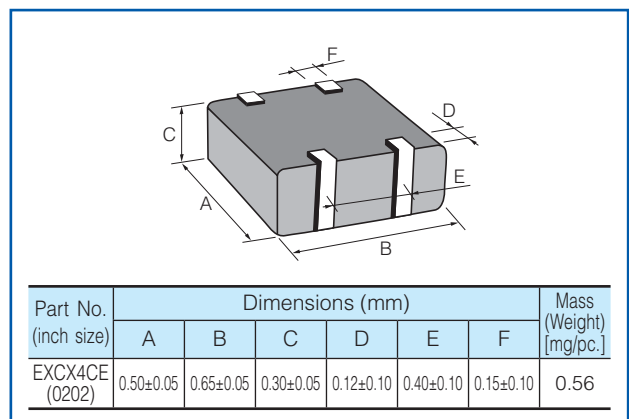

Circuit Configuration (No Polarity)

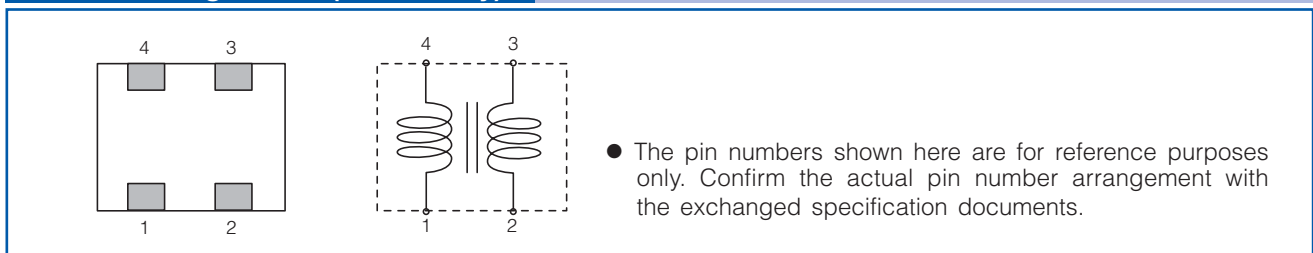

Ratings

Part Number	Impedance (Ω) at 100 MHz		Rated Voltage (V DC)	Rated Current (mA DC)	DC Resistance (Ω)max.
	Common Mode	Differential Mode			
EXCX4CE600U	60 Ω \pm 20 %	18 Ω max.	5	100	2.4 \pm 30 %
EXCX4CE900U	90 Ω \pm 20 %	20 Ω max.	5	100	3.0 \pm 30 %

- Category Temperature Range -40 °C to $+85$ °C

Impedance Characteristics (Typical)

● EXCX4CE600U

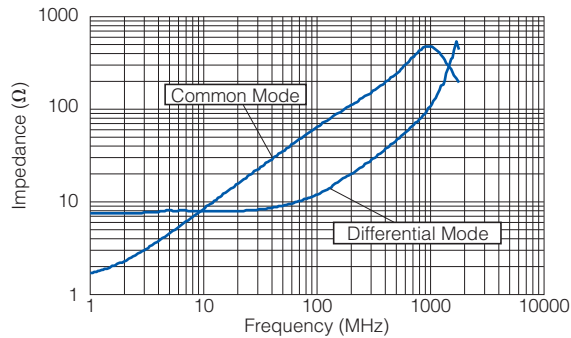

● EXCX4CE900U

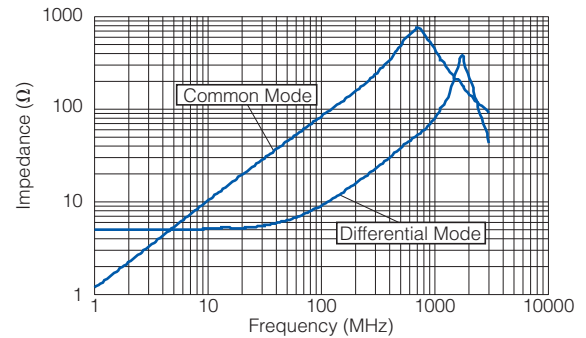

● Measurement Circuit

(A) Common Mode

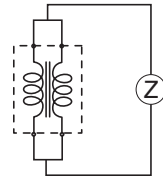

(B) Differential Mode

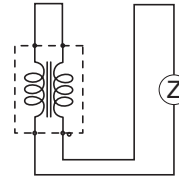

- As for Packaging Methods, Land Pattern, Soldering Conditions and Safety Precautions, Please see Data Files

Performance

Test Item	Performance Requirements	Test Conditions
Resistance	Within Specified Tolerance	25 °C
Overload	–	Rated Voltage
Resistance to Soldering Heat	±30 % (Impedance Change)	260 °C, 10 s
Rapid Change of Temperature	±30 % (Impedance Change)	–40 °C (30 min.) / +85 °C (30 min.), 200 cycles
High Temperature Exposure	±30 % (Impedance Change)	85 °C, 500 h
Damp Heat, Steady State	±30 % (Impedance Change)	60 °C, 95 %RH, 500 h
Load Life in Humidity	±30 % (Impedance Change)	60 °C, 95 %RH, Rated Current, 500 h

Guidelines and precautions regarding the technical information and use of our products described in this online catalog.

- If you want to use our products described in this online catalog for applications requiring special qualities or reliability, or for applications where the failure or malfunction of the products may directly jeopardize human life or potentially cause personal injury (e.g. aircraft and aerospace equipment, traffic and transportation equipment, combustion equipment, medical equipment, accident prevention, anti-crime equipment, and/or safety equipment), it is necessary to verify whether the specifications of our products fit to such applications. Please ensure that you will ask and check with our inquiry desk as to whether the specifications of our products fit to such applications use before you use our products.
- The quality and performance of our products as described in this online catalog only apply to our products when used in isolation. Therefore, please ensure you evaluate and verify our products under the specific circumstances in which our products are assembled in your own products and in which our products will actually be used.
- If you use our products in equipment that requires a high degree of reliability, regardless of the application, it is recommended that you set up protection circuits and redundancy circuits in order to ensure safety of your equipment.
- The products and product specifications described in this online catalog are subject to change for improvement without prior notice. Therefore, please be sure to request and confirm the latest product specifications which explain the specifications of our products in detail, before you finalize the design of your applications, purchase, or use our products.
- The technical information in this online catalog provides examples of our products' typical operations and application circuits. We do not guarantee the non-infringement of third party's intellectual property rights and we do not grant any license, right, or interest in our intellectual property.
- If any of our products, product specifications and/or technical information in this online catalog is to be exported or provided to non-residents, the laws and regulations of the exporting country, especially with regard to security and export control, shall be observed.

<Regarding the Certificate of Compliance with the EU RoHS Directive/REACH Regulations>

- The switchover date for compliance with the RoHS Directive/REACH Regulations varies depending on the part number or series of our products.
- When you use the inventory of our products for which it is unclear whether those products are compliant with the RoHS Directive/REACH Regulation, please select "Sales Inquiry" in the website inquiry form and contact us.

We do not take any responsibility for the use of our products outside the scope of the specifications, descriptions, guidelines and precautions described in this online catalog.
