

1

2

3

4

A

A

B

B

C

C

D

D

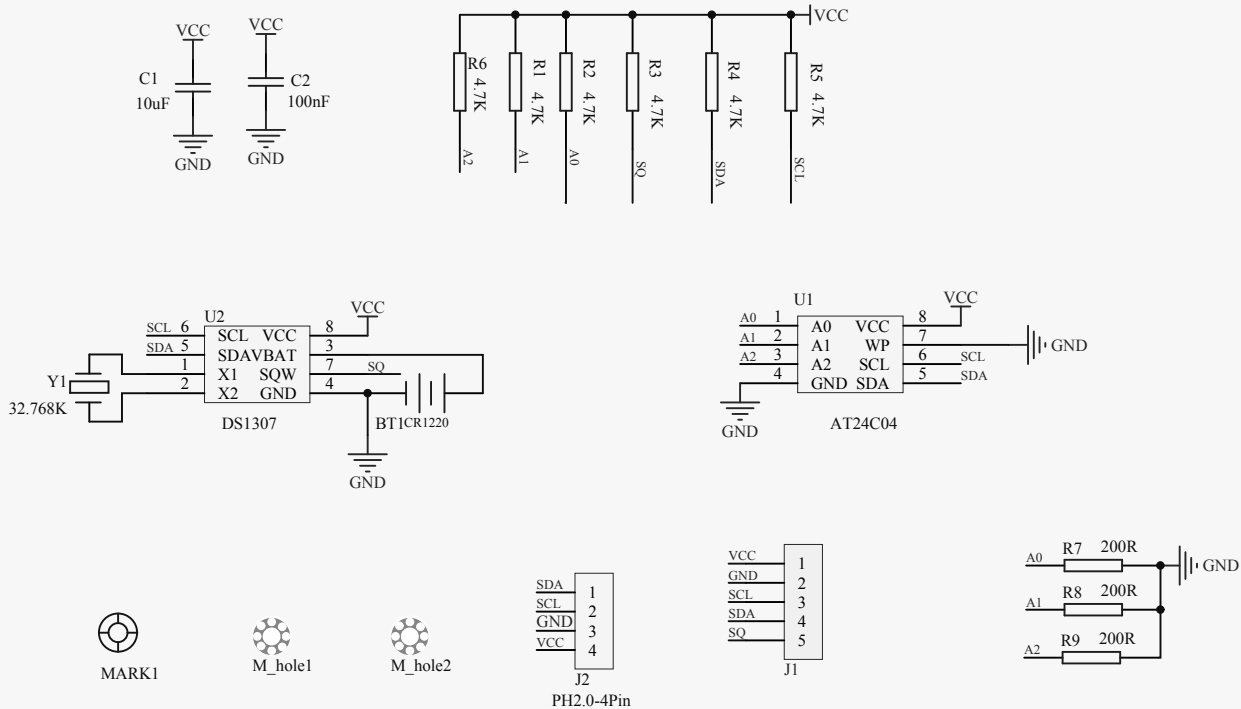

Title: Real Time Clock Module		SKU: DFR0151
Drawn: DongZi-CD	Revision: V1.0	Size: A4
Page: 1 of 1	Date: 2017-09-08	Time: 13:22:26

1

2

3

4

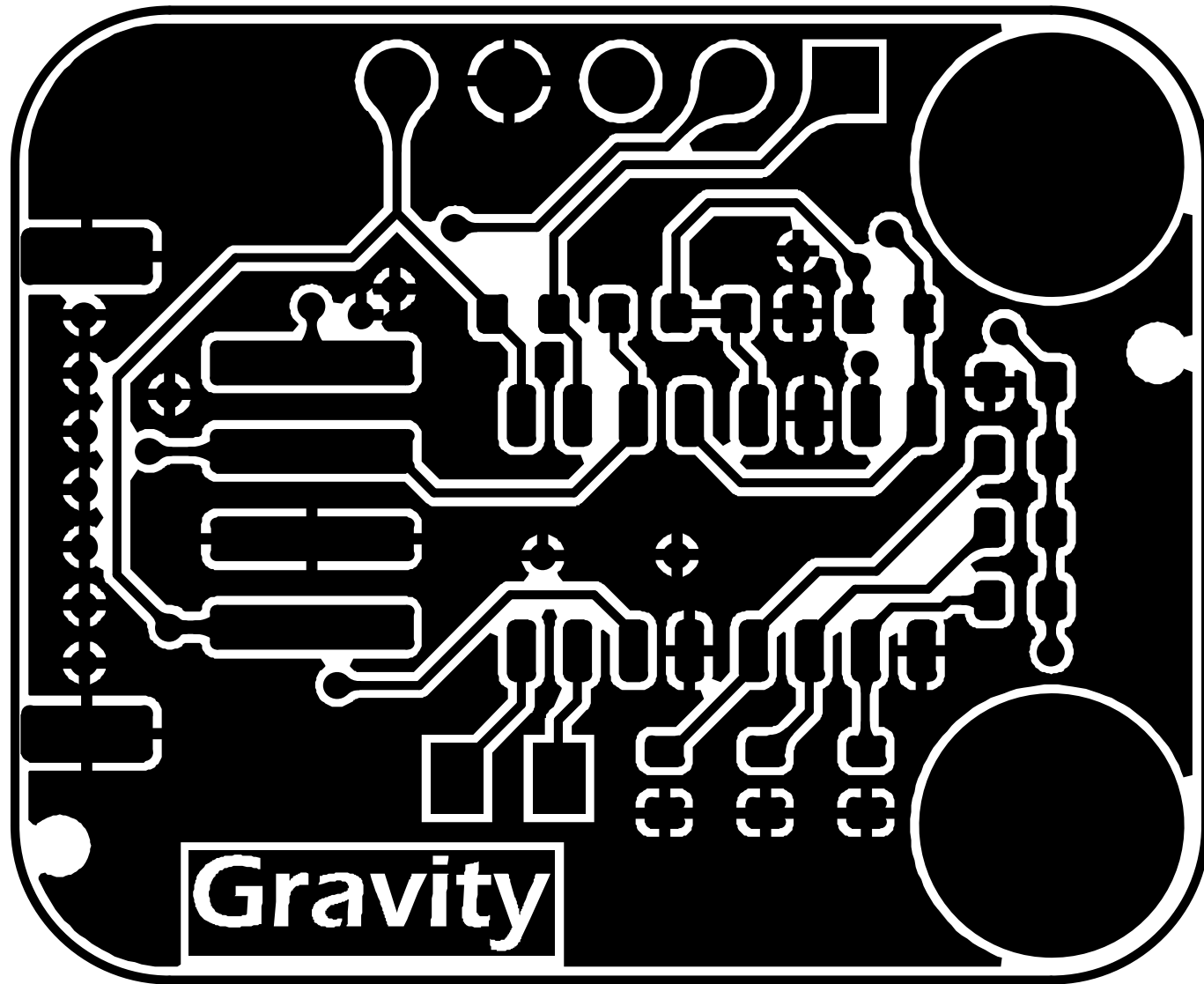

PCB Information	Name: DFR0151[V1.0]	Thickness: 1.6mm
Engineer: DongZi	Top SolderMask: Black	Bottom SolderMask: Black
Date: 20170908	Top Silkscreen: White	Bottom Silkscreen: White

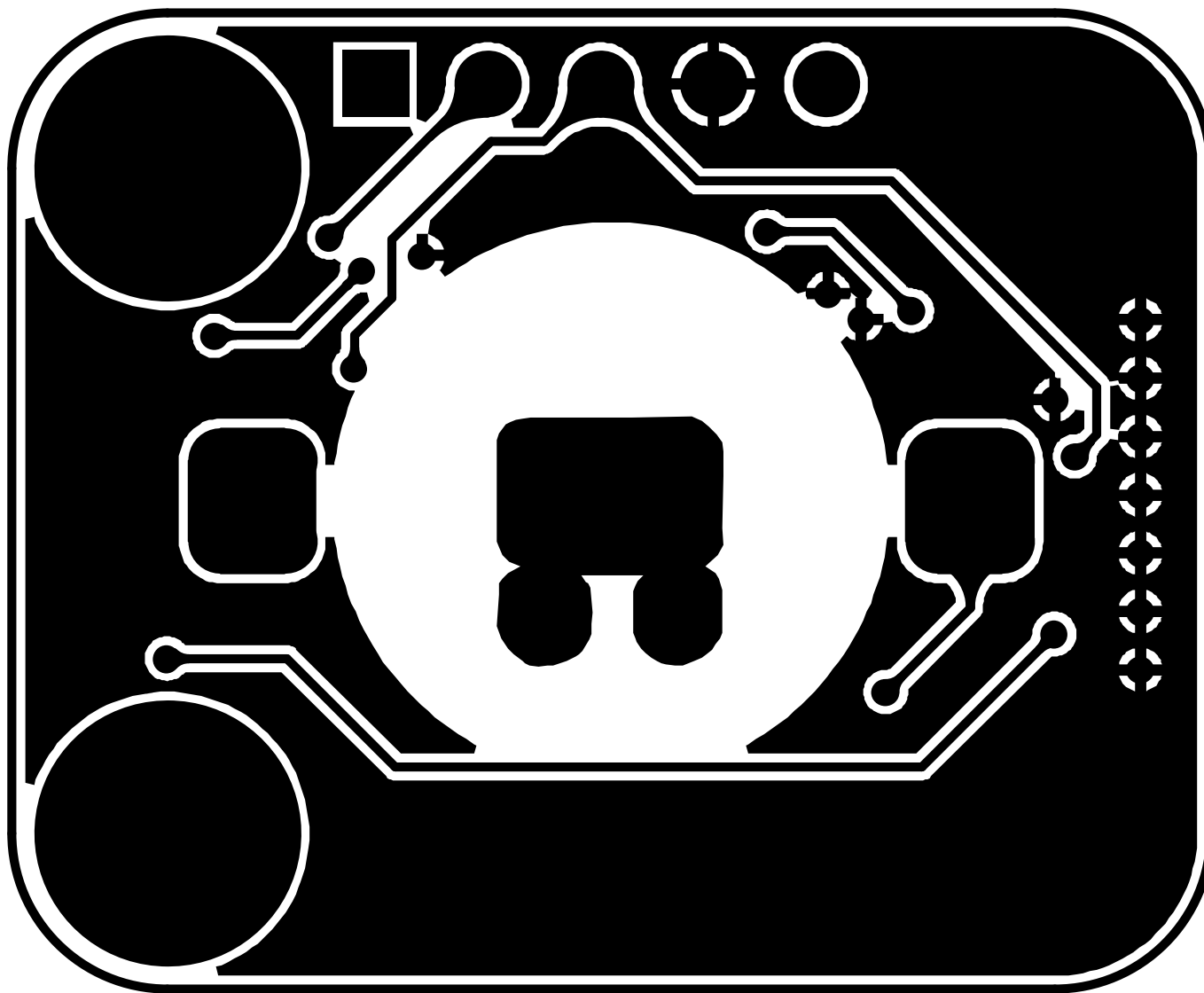

PCB Information	Name: DFR0151[V1.0]	Thickness: 1.6mm
Engineer: DangZi	Top SolderMask: Black	Bottom SolderMask: Black
Date: 20170908	Top Silkscreen: White	Bottom Silkscreen: White

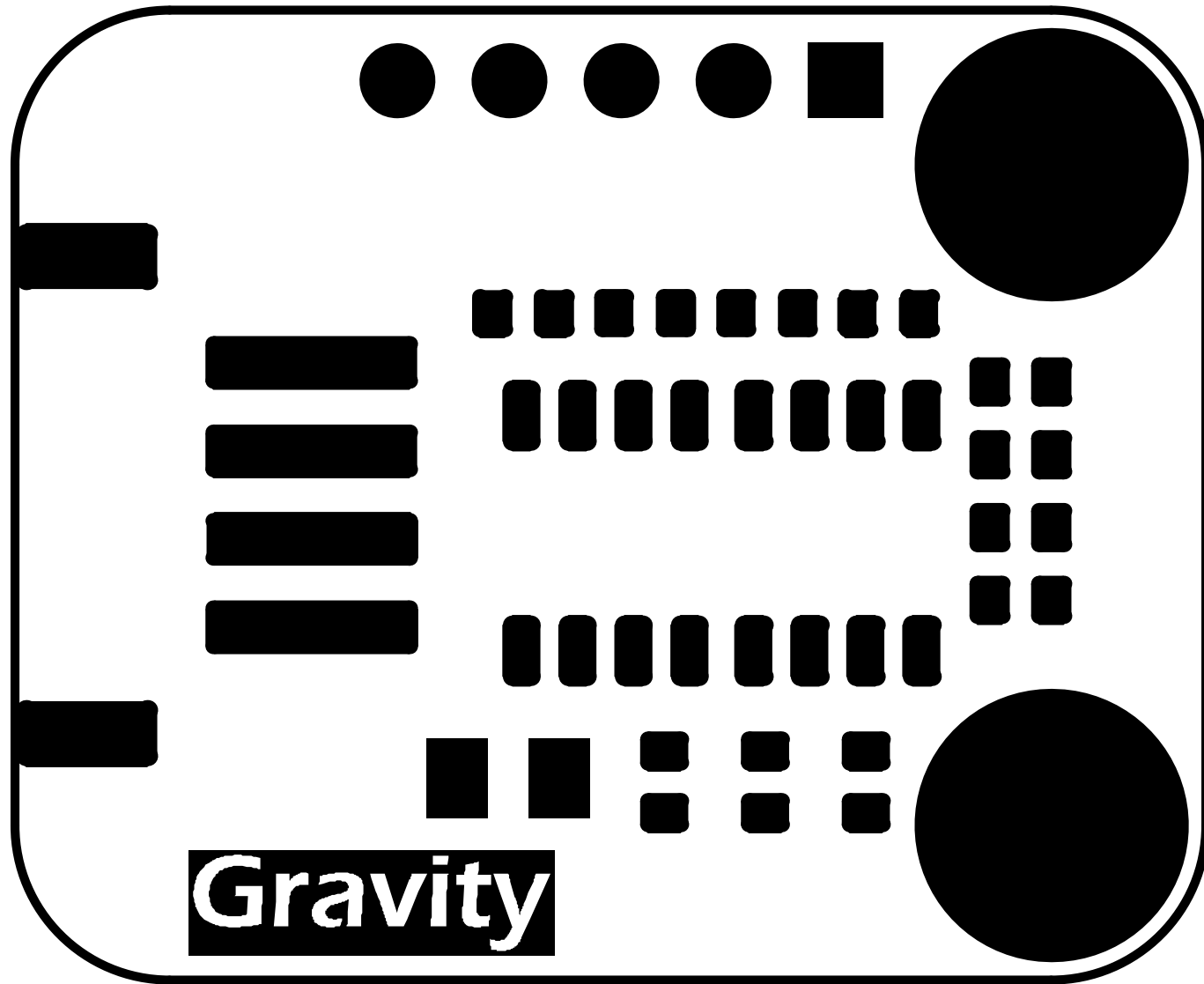

PCB Information	Name: DFR0151[V1.0]	Thickness: 1.6mm
Engineer: DongZi	Top SolderMask: Black	Bottom SolderMask: Black
Date: 20170908	Top Silkscreen: White	Bottom Silkscreen: White

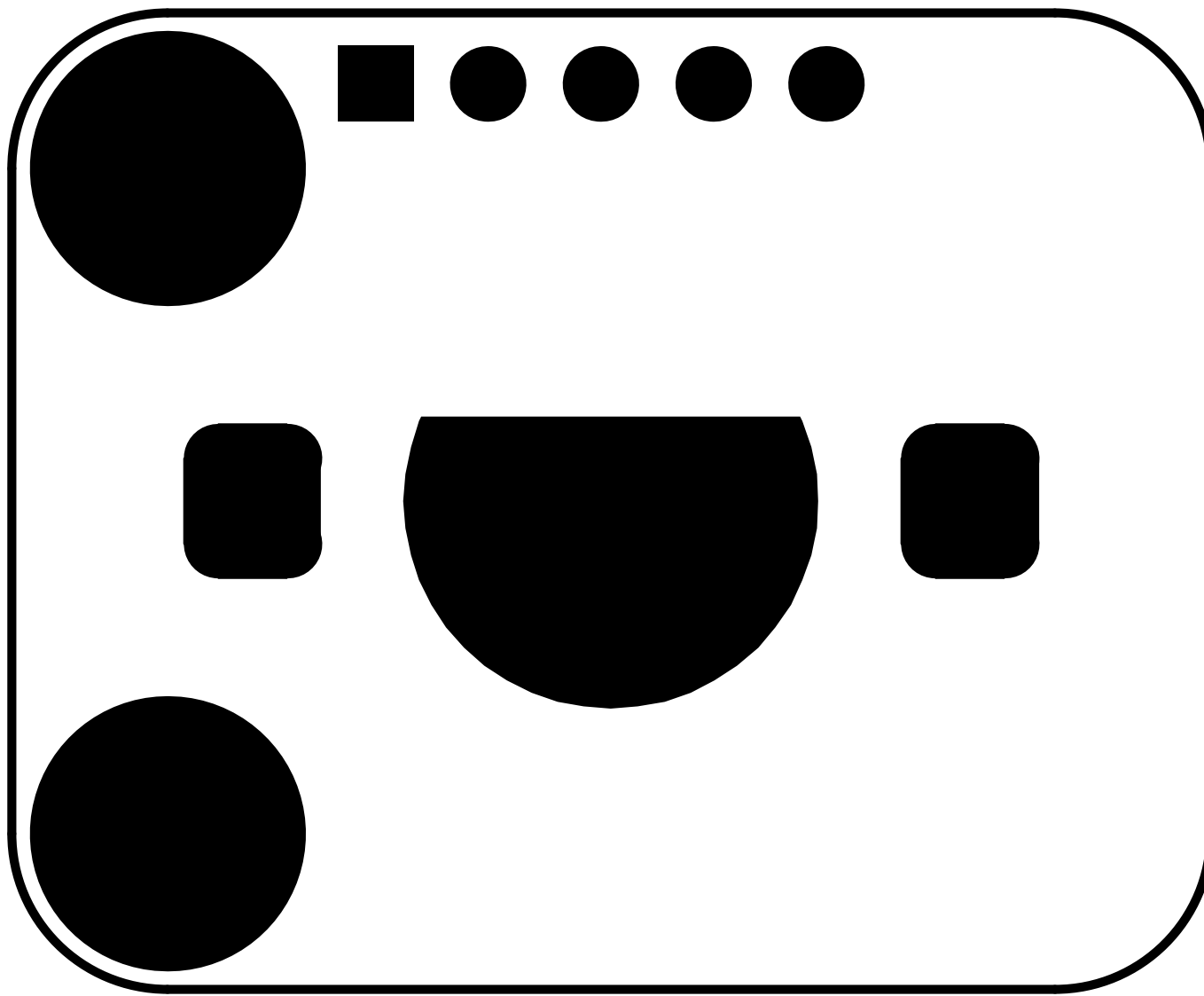

PCB Information	Name: DFR0151[V1.0]	Thickness: 1.6mm
Engineer: DangZi	Top SolderMask: Black	Bottom SolderMask: Black
Date: 20170908	Top Silkscreen: White	Bottom Silkscreen: White

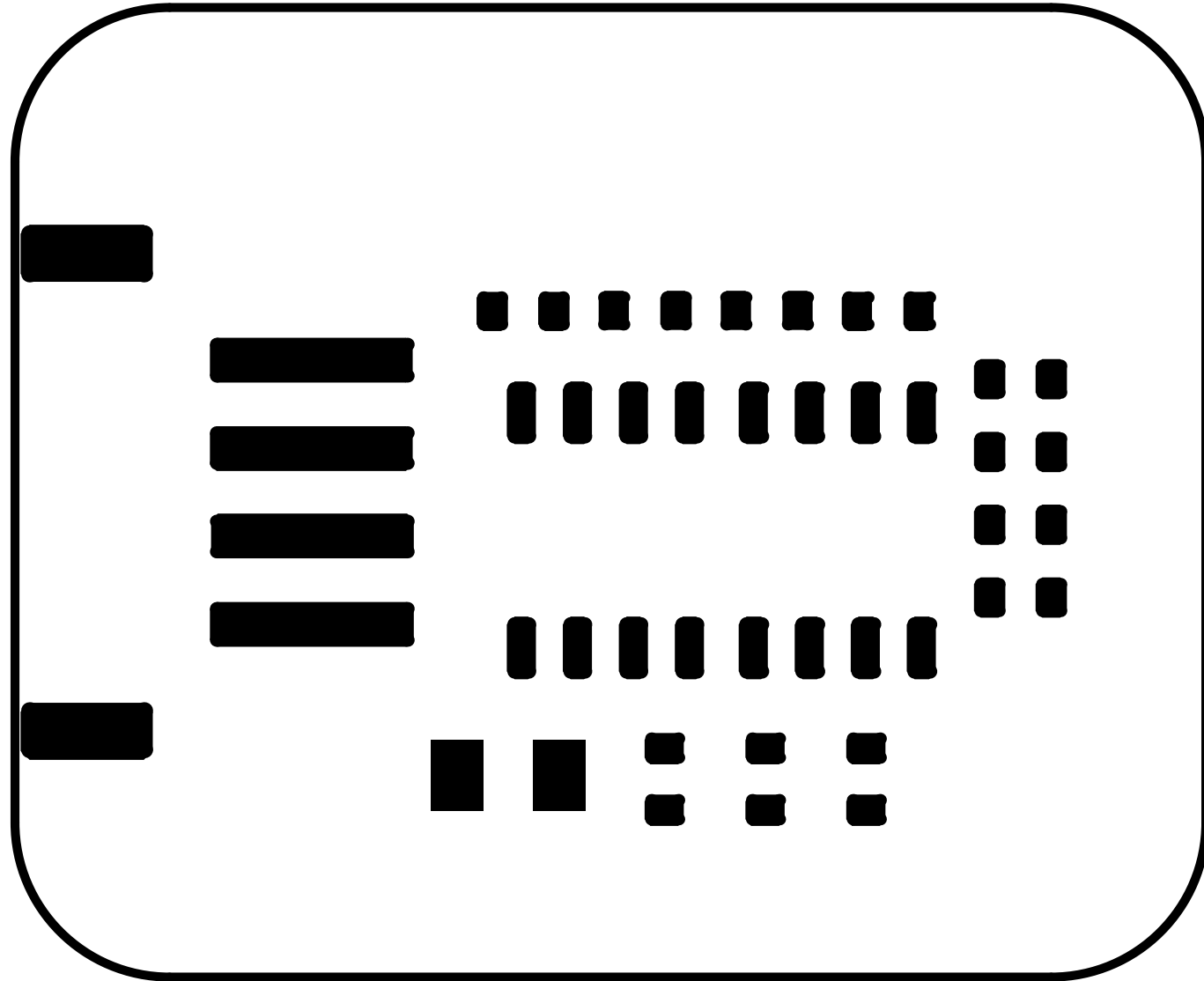

PCB Information	Name: DFR0151[V1.0]	Thickness: 1.6mm
Engineer: DongZi	Top SolderMask: Black	Bottom SolderMask: Black
Date: 20170908	Top Silkscreen: White	Bottom Silkscreen: White

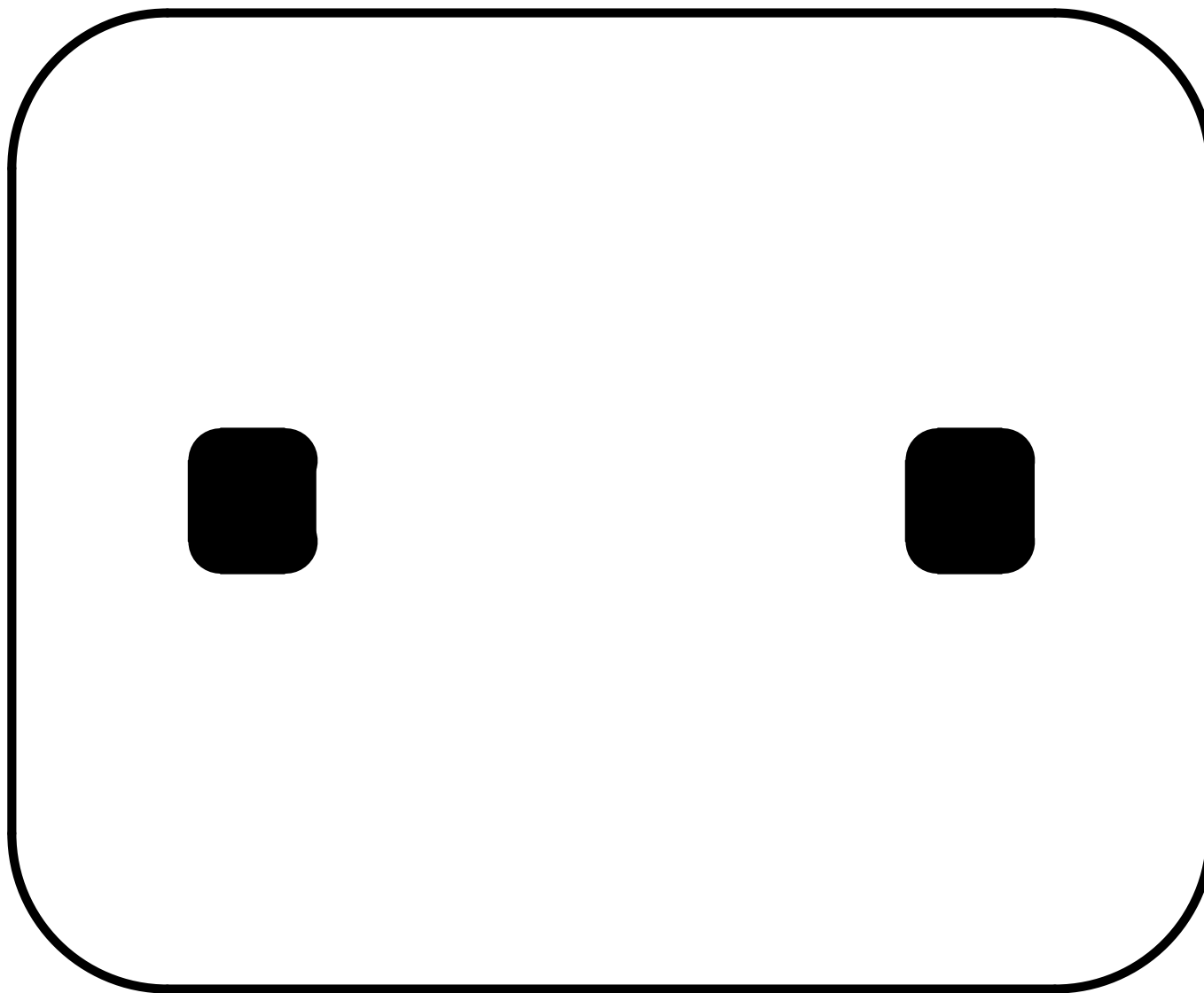

PCB Information	Name: DFR0151[V1.0]	Thickness: 1.6mm
Engineer: DangZi	Top SolderMask: Black	Bottom SolderMask: Black
Date: 20170908	Top Silkscreen: White	Bottom Silkscreen: White

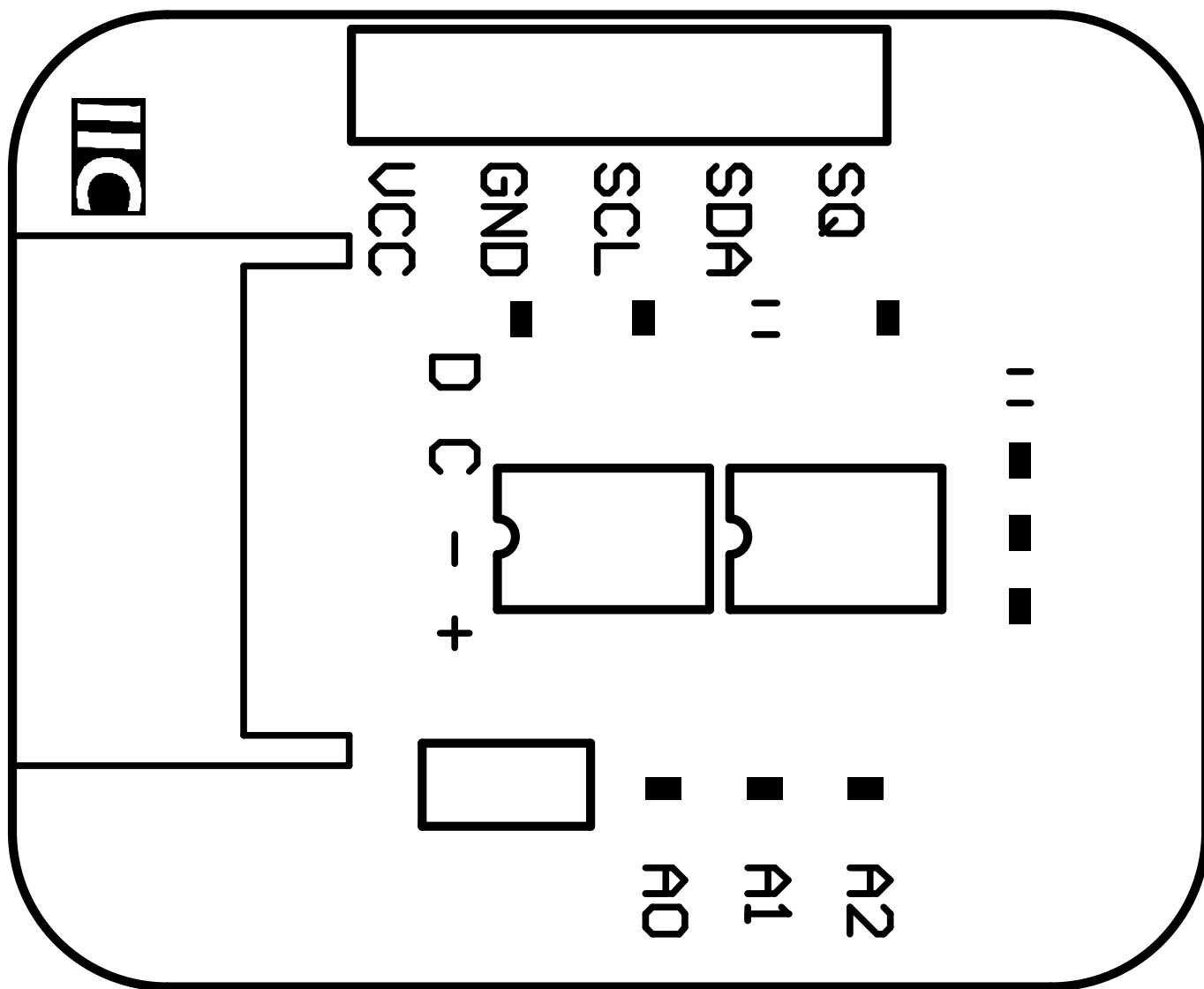

PCB Information	Name: DFR0151[V1.0]	Thickness: 1.6mm
Engineer: DongZi	Top SolderMask: Black	Bottom SolderMask: Black
Date: 20170908	Top Silkscreen: White	Bottom Silkscreen: White

Real Time Clock Module V1.0

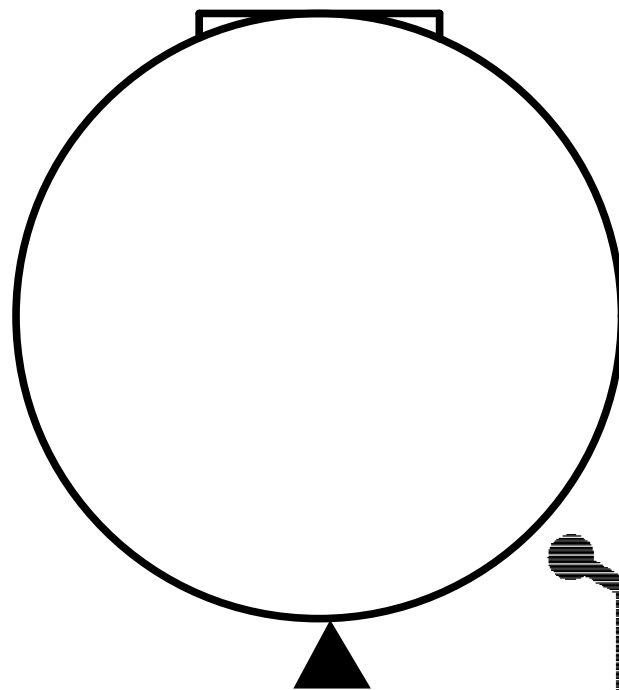

CR1220

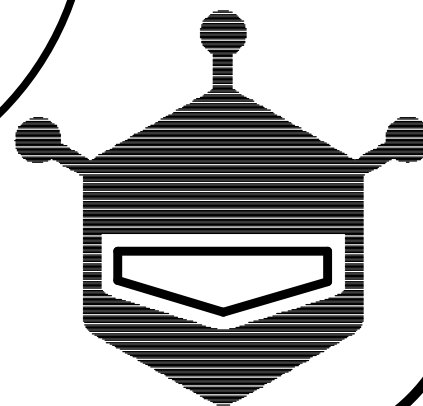

PCB Information	Name: DFR0151[V1.0]	Thickness: 1.6mm
Engineer: DangZi	Top SolderMask: Black	Bottom SolderMask: Black
Date: 20170908	Top Silkscreen: White	Bottom Silkscreen: White

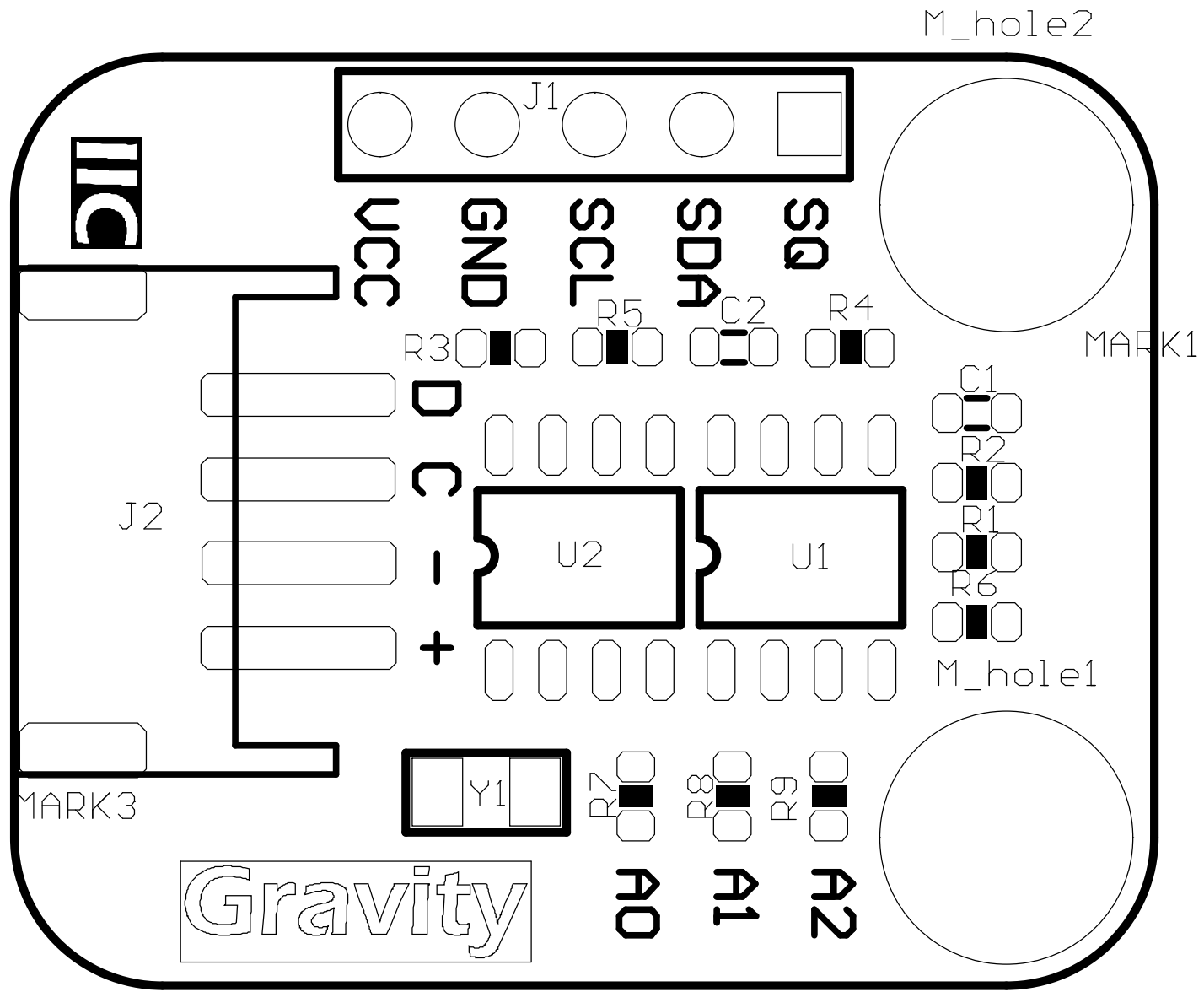

PCB Information	Name: DFR0151[V1.0]	Thickness: 1.6mm
Engineer: DongZi	Top SolderMask: Black	Bottom SolderMask: Black
Date: 20170908	Top Silkscreen: White	Bottom Silkscreen: White

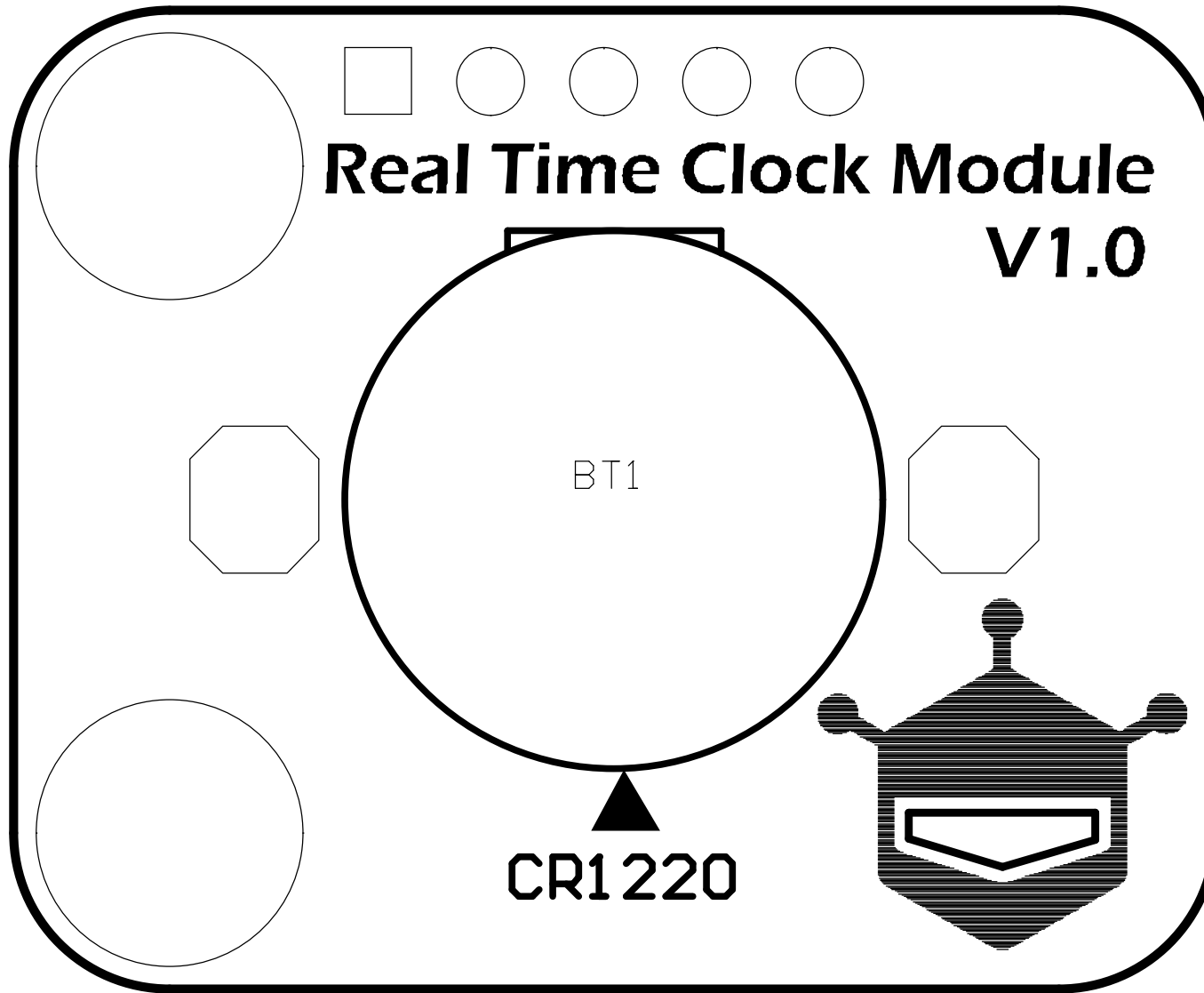

PCB Information	Name: DFR0151[V1.0]	Thickness: 1.6mm
Engineer: DangZi	Top SolderMask: Black	Bottom SolderMask: Black
Date: 20170908	Top Silkscreen: White	Bottom Silkscreen: White

2*R 1.55

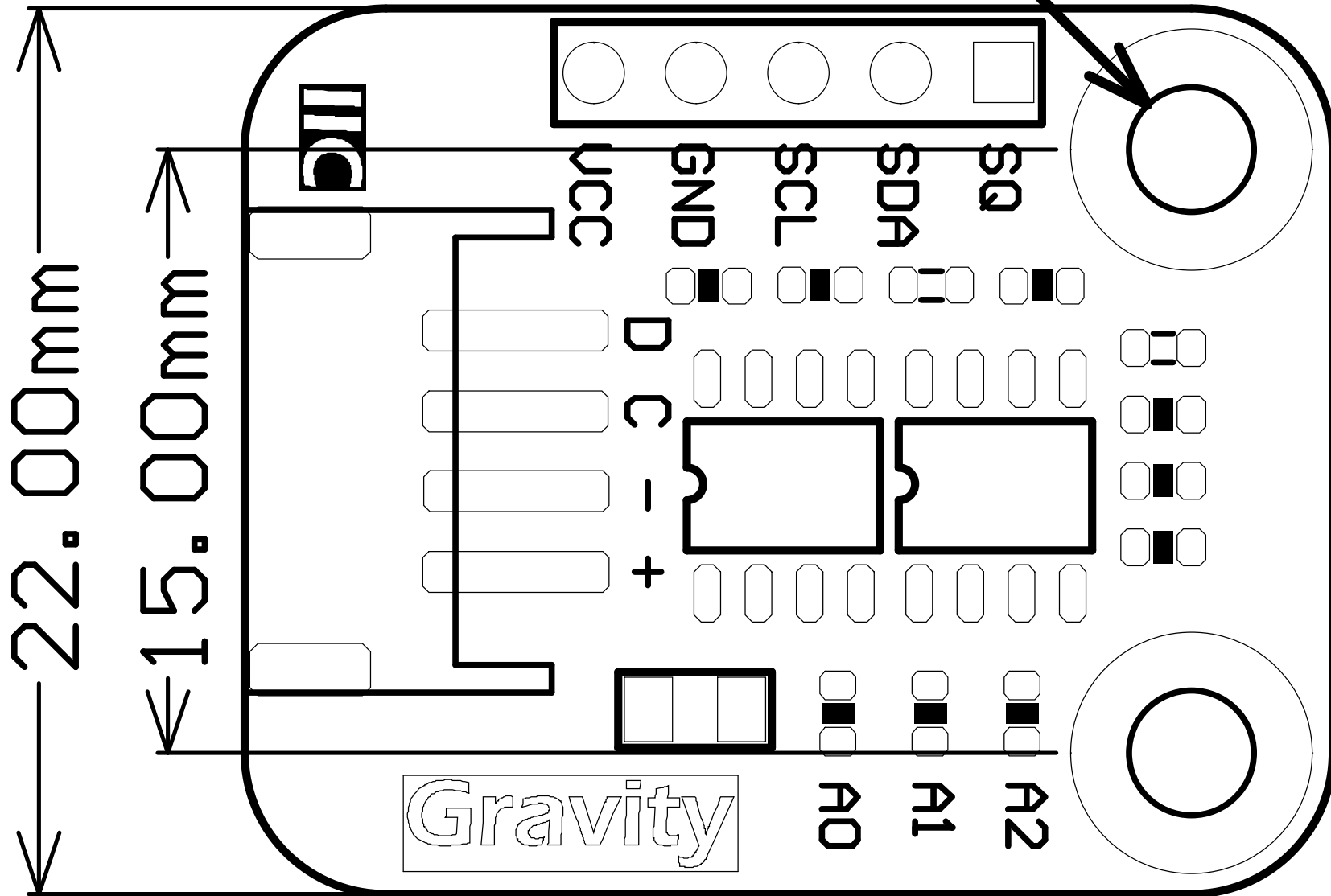

PCB Information	Name: DFR0151[V1.0]	Thickness: 1.6mm
Engineer: DongZi	Top SolderMask: Black	Bottom SolderMask: Black
Date: 20170908	Top Silkscreen: White	Bottom Silkscreen: White

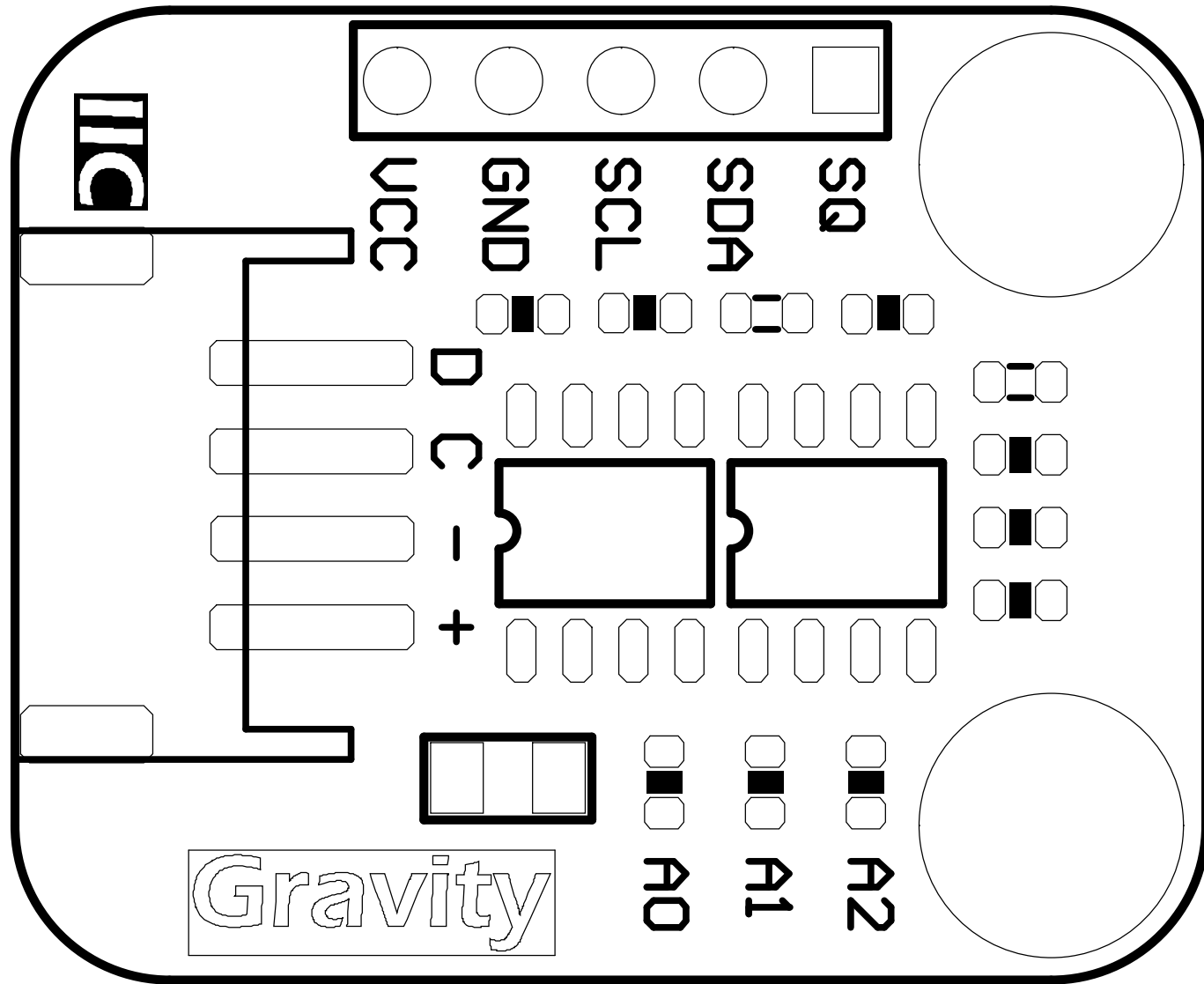

PCB Information	Name: DFR0151[V1.0]	Thickness: 1.6mm
Engineer: DongZi	Top SolderMask: Black	Bottom SolderMask: Black
Date: 20170908	Top Silkscreen: White	Bottom Silkscreen: White

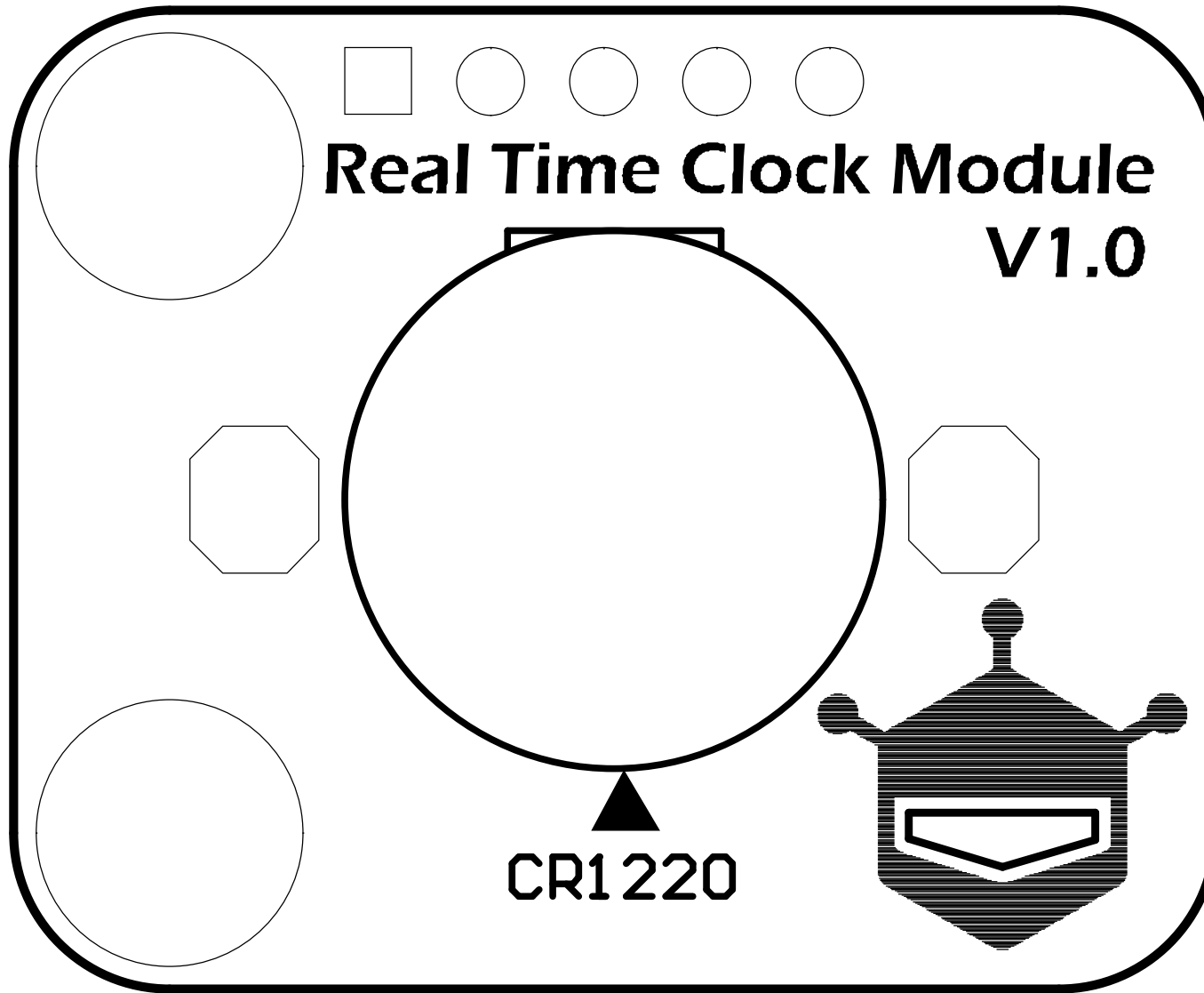

PCB Information	Name: DFR0151[V1.0]	Thickness: 1.6mm
Engineer: DangZi	Top SolderMask: Black	Bottom SolderMask: Black
Date: 20170908	Top Silkscreen: White	Bottom Silkscreen: White