

P	LTR	DESCRIPTION	DATE	DWN	APVD
	E1	6 POS PART 1-282845-4 ADDED	29 JUN 2020	SS	PS

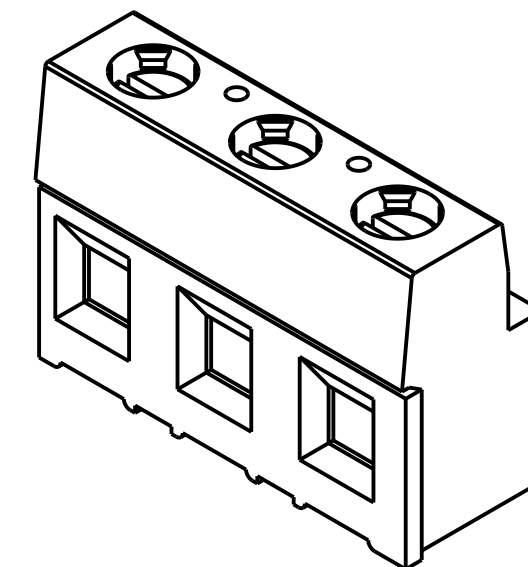

282845-3 AS SHOWN

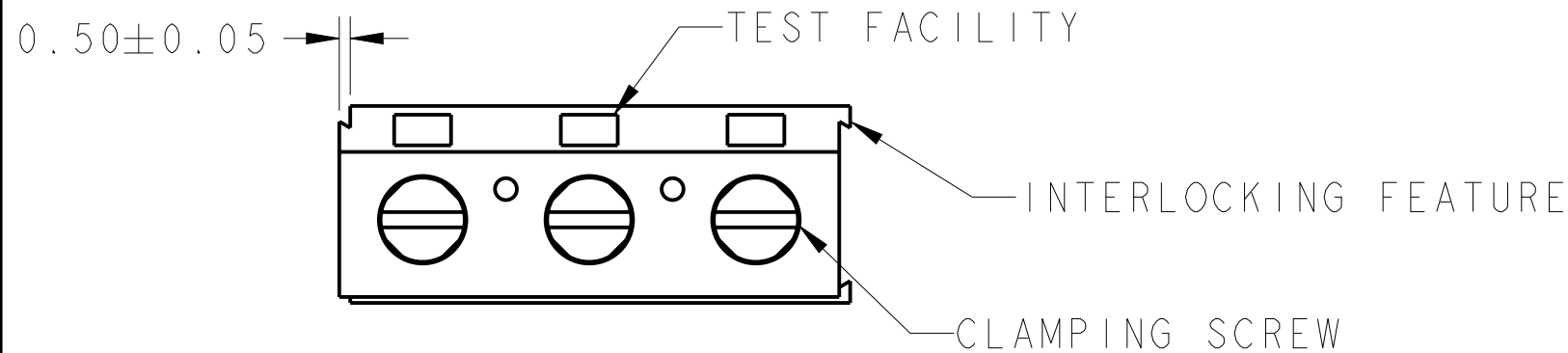
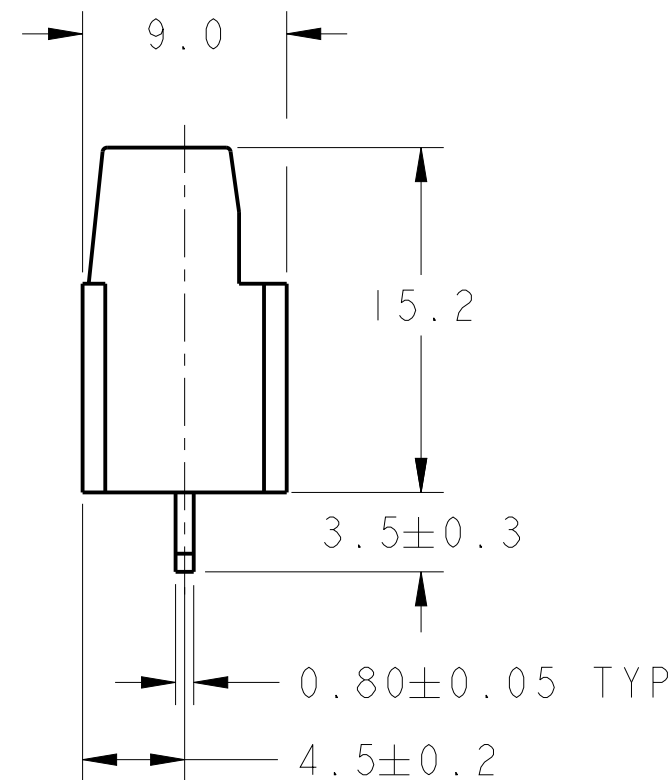
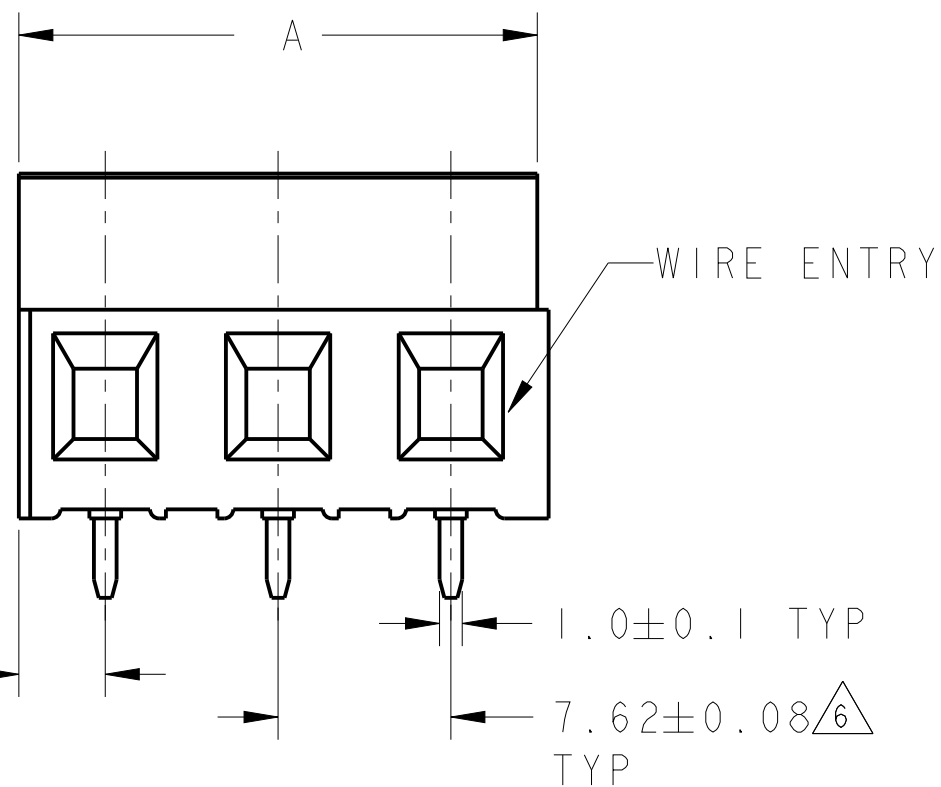

-	45.72	6	9	1-282845-4
7	SEE SHEET 2	22.86	3	1-282845-3
7	SEE SHEET 2	68.58	9	1-282845-2
7	SEE SHEET 2	22.86	3	1-282845-1
7	SEE SHEET 2	15.24	2	1-282845-0
7	SEE SHEET 2	15.24	2	282845-9
7	SEE SHEET 2	22.86	3	282845-8
7	SEE SHEET 2	15.24	2	282845-7
7	SEE SHEET 2	15.24	2	282845-6
7	SEE SHEET 2	22.86	3	282845-5
-	22.86	3		282845-3
-	15.24	2		282845-2
MARKING		DIM A	POS	PART NUMBER

RECOMMENDED PC BOARD LAYOUT

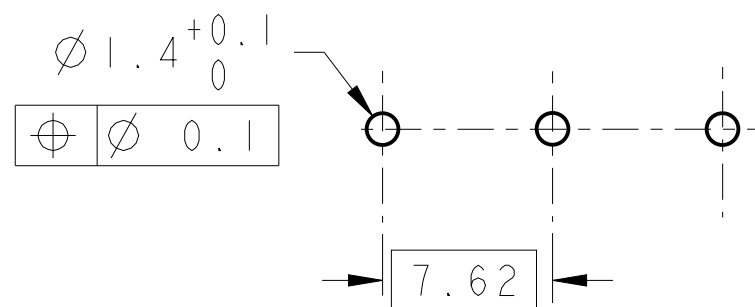

THIS DRAWING IS A CONTROLLED DOCUMENT.		DWN E. ZANOLINI 16AUG2001	TE Connectivity	
DIMENSIONS: mm		CHK D. BIEVENOUR 16AUG2001		
TOLERANCES UNLESS OTHERWISE SPECIFIED:		APVD D. BIEVENOUR 16AUG2001	NAME TERMINAL BLOCK PCB MOUNT SIDE WIRE ENTRY, STACKING W/INTERLOCK, 7.62mm PITCH	
0 PLC ± 1 PLC ±.3 2 PLC ±.25 3 PLC ± 4 PLC ± ANGLES ±°		PRODUCT SPEC	RESTRICTED TO	
MATERIAL		APPLICATION SPEC 114-20079	SIZE A3	CAGE CODE 00779
FINISH		WEIGHT -	DRAWING NO C-282845	
		CUSTOMER DRAWING	SCALE 3:1	SHEET 1 OF 2
				REV E1

P	LTR	DESCRIPTION	DATE	DWN	APVD
-		SEE SHEET 1	-	-	-

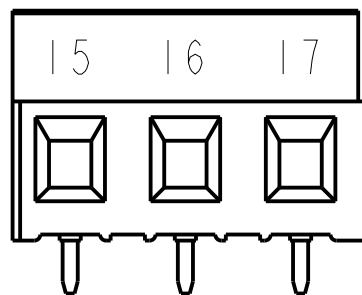

P/N 282845-5 AS SHOWN

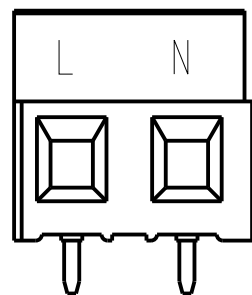

P/N 282845-6 AS SHOWN

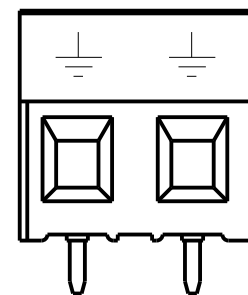

P/N 282845-7 AS SHOWN

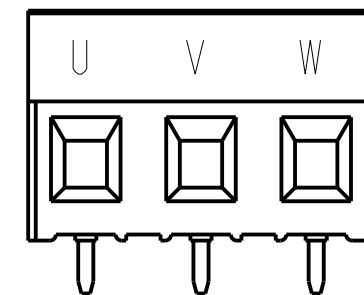

P/N 282845-8 AS SHOWN

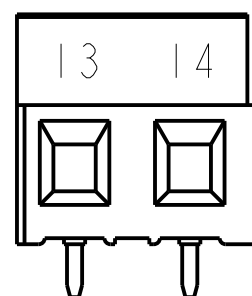

P/N 282845-9 AS SHOWN

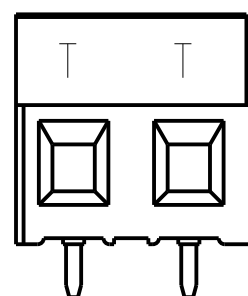

P/N 1-282845-0 AS SHOWN

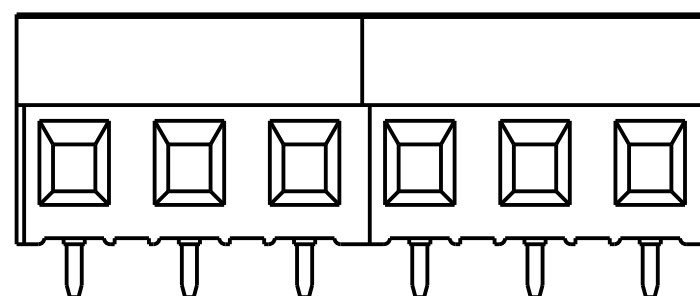

P/N 1-282845-4 AS SHOWN

1. MATERIALS AND FINISH  
 HOUSING: PA 6-6, UL 94-V0, COLOR GREEN.  
 CLAMP: BRASS, NICKEL PLATED.  
 TERMINAL: BRASS, TIN PLATED.  
 CLAMPING SCREW: M3, BRASS, NICKEL PLATED

- 2. SUITABLE FOR 1,6-2,4mm. PCB THICKNESS.
- 3. END-TO-END STACKABLE W/INTERLOCK WITHOUT LOSS OF CENTERLINE SPACING.
- 4. WIRE SIZE RANGE : 30-12 AWG
- 5. RECOGNIZED UNDER THE COMPONENT PROGRAM OF UNDERWRITERS LABORATORIES INC. FILE NO E60677.

- 6. NOT CUMULATIVE TOLERANCE.
- 7. INK MARKING, BLACK COLOR
- 8. P/N 1-282845-2 IS OBTAINED BY GLUING AND ASSEMBLING TOGETHER No.1 CONNECTOR P/N 282845-6, No.1 CONNECTOR P/N 282845-7, No.1 CONNECTOR P/N 282845-8 AND No.1 CONNECTOR P/N 1-282845-0
- 9. P/N 1-282845-4 IS OBTAINED BY INTERLOCKING 2 NO.OF CONNECTOR P/N 282845-3.

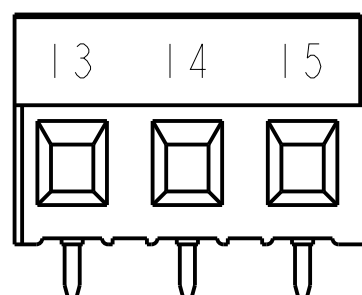

P/N 1-282845-1 AS SHOWN

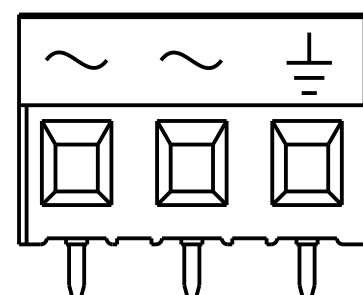

P/N 1-282845-3 AS SHOWN

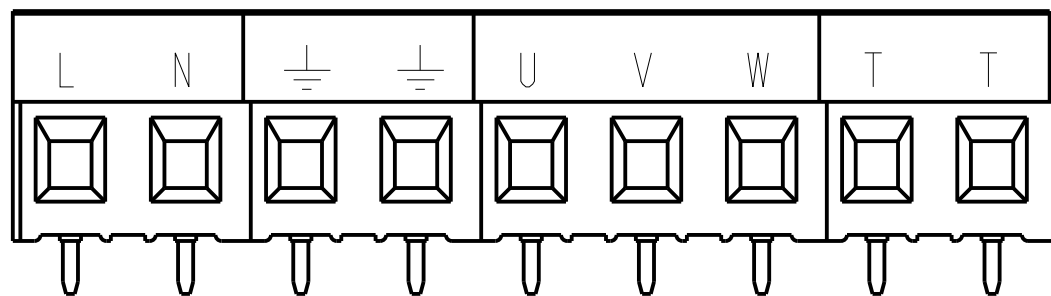

P/N 1-282845-2 AS SHOWN

THIS DRAWING IS A CONTROLLED DOCUMENT.

DIMENSIONS:	TOLERANCES UNLESS OTHERWISE SPECIFIED:
mm	
0 PLC	±0
1 PLC	±.3
2 PLC	±.25
3 PLC	±0
4 PLC	±0
ANGLES	±2°

MATERIAL	FINISH
1	1

DWN	E. ZANOLINI	16AUG2001
CHK	D. BIEVENOUR	16AUG2001
APVD	D. BIEVENOUR	16AUG2001
PRODUCT SPEC	108-20166	
APPLICATION SPEC	114-20079	
WEIGHT	-	
CUSTOMER DRAWING		

<b>TE</b> TE Connectivity			
NAME TERMINAL BLOCK PCB MOUNT SIDE WIRE ENTRY, STACKING W/INTERLOCK, 7.62mm PITCH			
SIZE	CAGE CODE	DRAWING NO	RESTRICTED TO
A3	00779	C=282845	-
SCALE		SHEET	REV
2:1		2 OF 2	E1