

RECOMMENDED P.C.B LAYOUT

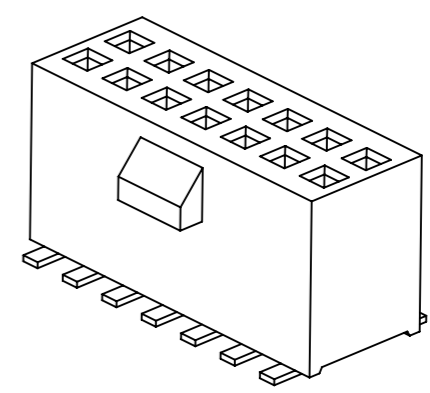
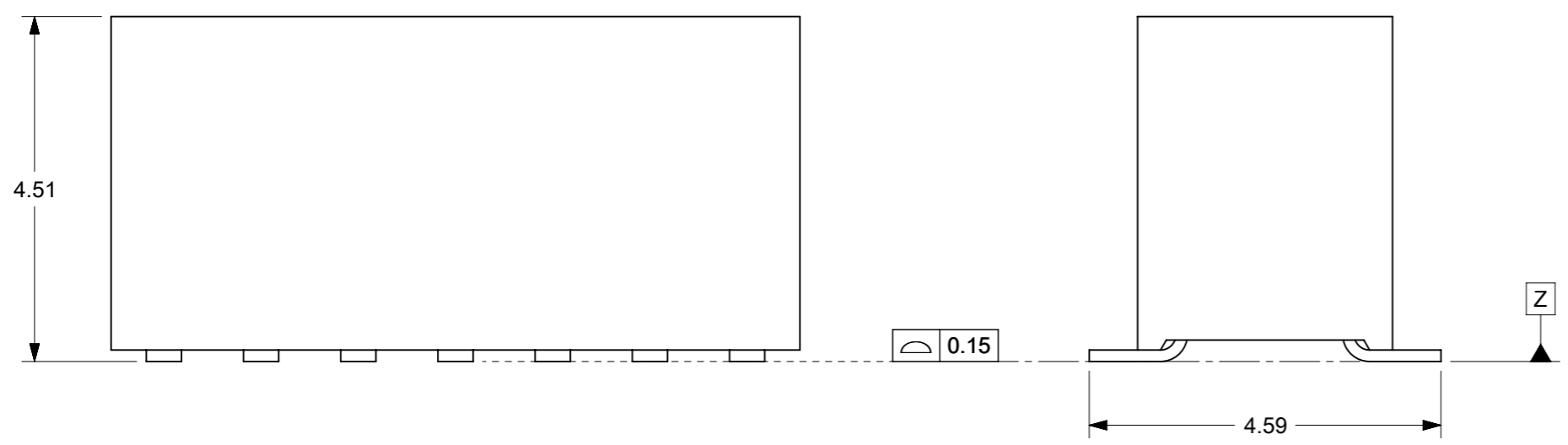

- NOTE:**
1. MATERIAL: HOUSING: LCP GLASS FILLED, COLOR: BLACK
TERMINAL: PHOSPHOR BRONZE WITH 0.25µm GOLD AT CONTACT AREA OVER 1.27µm NICKEL UNDERPLATE.
 2. PIN PUSHOUT FORCE: 0.4KG MIN
 3. THE ABOVE 14 CKT SHOWN IS FOR ILLUSTRATION ONLY.
 4. PARTS TO BE PACKED IN TUBE.
 5. PRODUCT SPECIFICATION PS-87933-001 APPLIES.
 6. THIS PART IS TO BE MATED WITH 87932, 87933 OR 87934 SERIES
 7. PACKAGING SPECIFICATION REFER TO PK-89990-576

P/N PACKED IN TUBE	CKT SIZE	KAPTON TAPE	DIMENSION	
			A	B
78120-0813	08	NO	5.19	3.81
78120-2013	20	NO	12.81	11.43
78120-3013	30	NO	19.16	17.78
78120-8013	80	NO	50.91	49.53
78120-0013	100	NO	63.61	62.23

THIS DRAWING CONTAINS INFORMATION THAT IS PROPRIETARY TO MOLEX ELECTRONIC TECHNOLOGIES, LLC AND SHOULD NOT BE USED WITHOUT WRITTEN PERMISSION

DIMENSION UNITS		SCALE		CURRENT REV DESC: REMASTERED & BTB DISTANCE UPDATE		molex	
MM	NTS						
GENERAL TOLERANCES (UNLESS SPECIFIED)				EC NO: 664214		1.27MM PITCH, DUAL ROW RECEPTACLE, SMT	
		MM	INCH	DRWN: KSUTAR 2021/05/07		PRODUCT CUSTOMER DRAWING	
4 PLACES ±		±	±	CHK'D: ABABUPS 2021/05/18		DOCUMENT NUMBER	
3 PLACES ±		±	±	APPR: MRAMAKRISHNA 2021/05/18		DOC TYPE DOC PART REVISION	
2 PLACES ±		0.15	±	INITIAL REVISION:		SD-78120-007	
1 PLACE ±		±	±	DRWN: CWLAM 2007/02/16		PSD 001 A4	
0 PLACES ±		±	±	APPR: KWLEE 2007/02/27		MATERIAL NUMBER CUSTOMER	
ANGULAR TOL ± 1.0°				DRAFT WHERE APPLICABLE MUST REMAIN WITHIN DIMENSIONS		SEE TABLE GENERAL MARKET	
THIRD ANGLE PROJECTION		DRAWING		SERIES		SHEET NUMBER	
A3-SIZE		78120		1 OF 2			

BOARD TO BOARD (BTB) DISTANCE

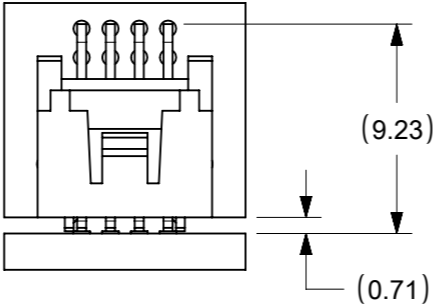
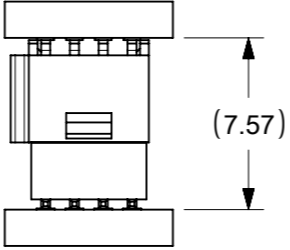
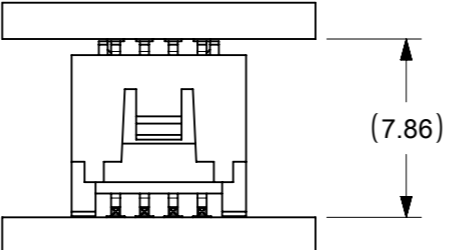
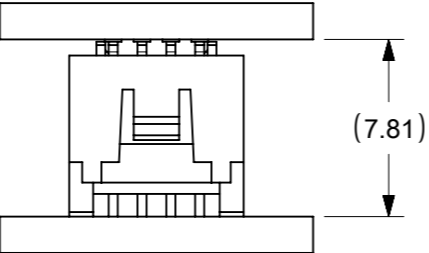
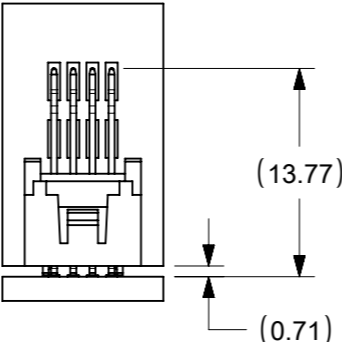
HEADER	MATES WITH (RECEPTACLE)	BTB DIST.	PICTORIAL VIEW
201021	78120	9.23	
87933		7.57	
200989		7.86	
201022		7.81	
201173		13.77	

THIS DRAWING CONTAINS INFORMATION THAT IS PROPRIETARY TO MOLEX ELECTRONIC TECHNOLOGIES, LLC AND SHOULD NOT BE USED WITHOUT WRITTEN PERMISSION

DIMENSION UNITS		SCALE		CURRENT REV DESC: REMASTERED & BTB DISTANCE UPDATE		molex	
MM	NTS						
GENERAL TOLERANCES (UNLESS SPECIFIED)				EC NO: 664214		1.27MM PITCH, DUAL ROW RECEPTACLE, SMT	
				DRWN: KSUTAR		2021/05/07	
				CHK'D: ABABUPS		2021/05/18	
				APPR: MRAMAKRISHNA		2021/05/18	
				INITIAL REVISION:		PRODUCT CUSTOMER DRAWING	
4 PLACES ±				DRWN: CWLAM		DOCUMENT NUMBER	
3 PLACES ±				APPR: KWLEE		SD-78120-007	
2 PLACES ± 0.15				2007/02/16		DOC TYPE	
1 PLACE ±				2007/02/27		PSD	
0 PLACES ±						DOC PART	
ANGULAR TOL ± 1.0°						001	
DRAFT WHERE APPLICABLE MUST REMAIN WITHIN DIMENSIONS				THIRD ANGLE PROJECTION		REVISION	
				DRAWING		A4	
				SERIES		SHEET NUMBER	
				A3-SIZE		2 OF 2	
				78120			
				MATERIAL NUMBER		CUSTOMER	
				SEE TABLE		GENERAL MARKET	