



INPAQ

Product Specification

Document NO.				
Description	Drawn by	Designed by	Checked by	Approved by
MNI-P Series	陳曉慧 Sharon Chen	賴柏志 Kidd Lai	賴柏志 Kidd Lai	吳維政 Albert Wu

RoHS  **Multilayer Inductor for NFC circuit (MNI-P Series) engineering Spec.**

■ **Part Number and Characteristics Table**

Part Number.	Inductance ±10% (nH)	DCR (Ω) Max.	Rated Current (mA)	SRF (MHz)Min.
1005 Series				
MNI1005PR16KBPDG	160	0.330	480	600
Test Instruments and Conditions	<ul style="list-style-type: none"> •HP4291B-RF Impedance / Material Analyzer •HP4338A/B Milliohm meter •Test Frequency : 13.56 MHz •OSC Level : 100mV 			

** For special part number which is not shown in the above table, please refer to appendix.

■ **Shapes and Dimensions**

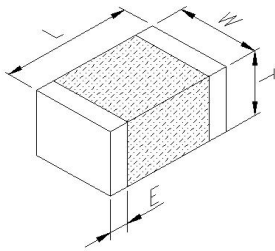

Type (mm)	1005 (EIA0402)
L	1.00±0.10
W	0.50±0.10
T	0.50±0.10
E	0.25±0.10

■ **Part Number Code**

MNI 1005 P R16 K B P DG
1 2 3 4 5 6 7 8

- 1 Series Name
- 2 Size Code : The first two digitals: length(mm) 、 the last two digitals: width(mm)
- 3 Material code
- 4 Inductance : R16 = 160nH
- 5 Tolerance : J = ± 5% 、 K = ± 10%
- 6 Soldering : Green Parts 、 B= Lead-Free for whole chip
- 7 Packaging : P - Paper tape, 7" reel.
- 8 INPAQ internal code

■ Typical Characteristic

Inductance @ Frequency

1005 Series

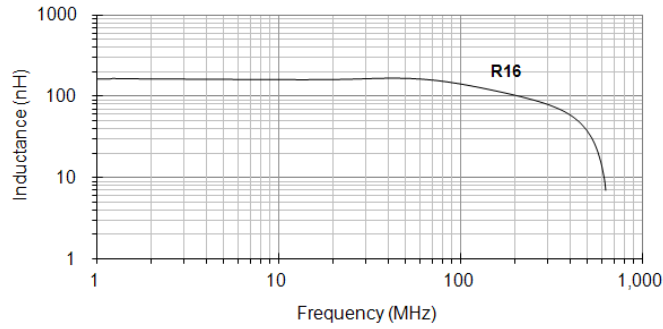

Q factor @ Frequency

1005 Series

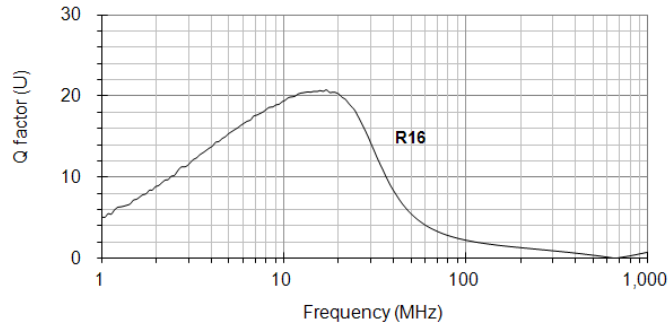

■ Tape and Reel Specifications

Paper Carrier (P)

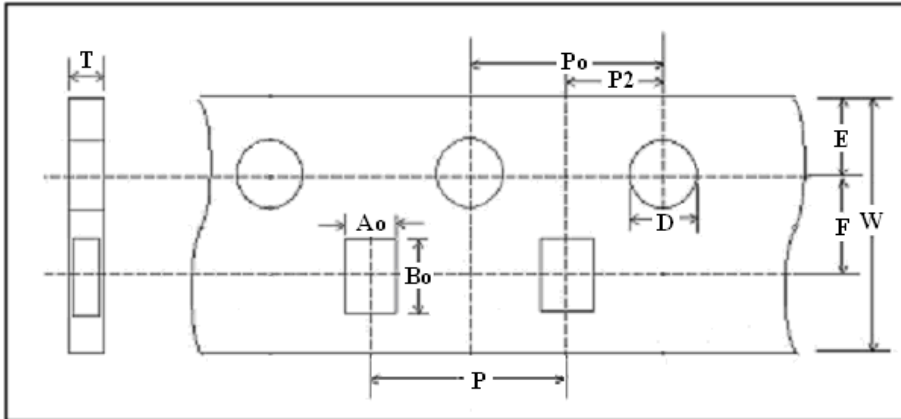

Taping Dimensions

Size (mm)	1005
Symbol	Paper
W	8.00±0.10
P	2.00±0.05
E	1.75±0.05
F	3.50±0.05
D	1.55±0.05
P ₀	4.00±0.10
P ₂	2.00±0.05
A ₀	0.62±0.03
B ₀	1.12±0.03
T	0.60±0.03

■ Reel Dimensions

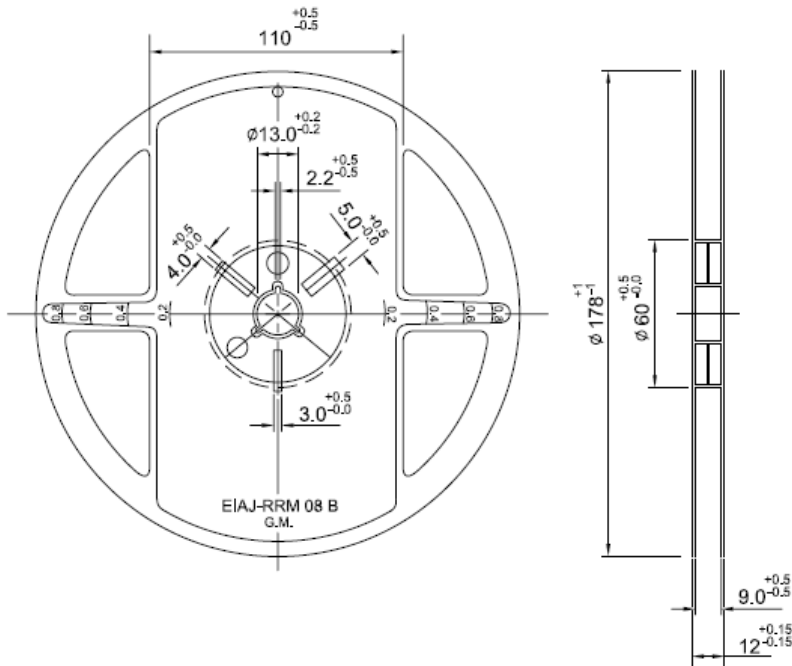

7" Reel Packaging Quantity	
PART SIZE (EIA size)	1005 (0402)
Qty.(pcs)	10,000
BOX	5 reels / inner box

■ Recommended Soldering Conditions

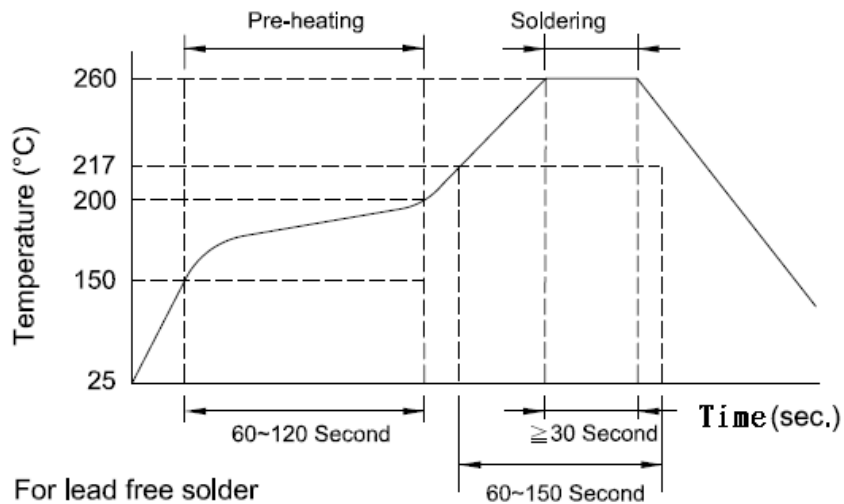

■ Land Patterns for Reflow Soldering

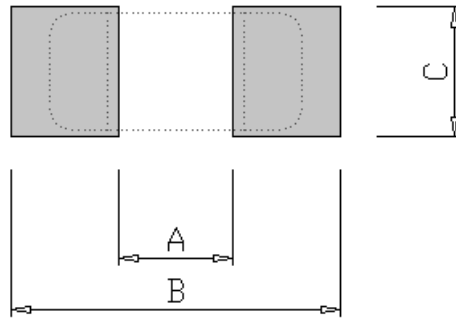

Solder land information :

Size (mm)	A	B	C
1005	0.40 ~ 0.60	1.20 ~ 1.40	0.40 ~ 0.70

■ GENERAL TECHNICAL DATA

Operating temperature range : - 40°C ~ +85°C

Storage Condition : Less than 40°C and 70% RH

Storage time : 6 months

Soldering method : Reflow